

Milwaukee[®]

Nothing but **HEAVY DUTY.**[™]



TiD-extra
Industrial Technologies d.o.o.

2021/22

ACCESSORIES AND HAND TOOLS CATALOGUE

Milwaukee®

Nothing but HEAVY DUTY.™

TiD-extra
Industrial Technologies





CONTENTS

DRILLING AND CHISELLING

Chisels

HEX 21 mm/ 28 mm/ 30 mm	27-30
SDS-Max	26
SDS-Max Sledge Chisels	23,24
SDS-Plus	25
SDS-Plus Sledge Chisels	23,24

Diamond Drilling

1 1/4" UNC / 1/2" G - Wet Diamond Drilling Core Drills	77-78
1 1/4" UNC / M16 - Dry Diamond Drilling Core Drills	80-84
1/4" Wet/Dry Diamond Drills	76
M14 Dry Diamond Drills	75
Wet/Dry Diamond Holesaws	75

Drill Bits: Concrete / Masonry

Round Shank - Concrete/Masonry	32-33
SDS-Max - Other	17, 19-22
SDS-Max 4 Cutter (MX4)	15-17
SDS-Max Core Cutters/Tunnel Bits	18-19
SDS-Plus - Other	12-13
SDS-Plus 2 Cutter (M2)	8-11
SDS-Plus 4 Cutter (MX4)	4-7
SDS-Plus Core Cutters	14
SDS-Plus Extensions	13

Drill Bits: Metal

Annular Cutters	60-62
HSS-G	48-52
HSS-G Red Cobalt	53, 55-56
HSS-G Ti Red Hex - SHOCKWAVE™ IMPACT DUTY	53-54
HSS-R	43-47
Step Drills	57-59

Drill Bits: Other

Glass & Tile	33
Multi Material	31

Drill Bits: Wood

Auger Bits	36
Auger Bits - SHOCKWAVE™ IMPACT DUTY	34
Cable Bits	42
Flat Bits	41
Forstner Bits	37
Lip & Spur Bits	40
Selffeed Bits	38
SPEED FEED™ Bits	42
SWITCHBLADE™ Selffeed Bits - SHOCKWAVE™ IMPACT DUTY	38-39

Holesaws

Adjustable Holesaw	70
BIG HAWG™ Multi Material	72
Contractor Bi-Metal	69
HCS PVC Holesaws	73
HOLE DOZER™ - Bi-Metal	66-68
HOLE DOZER™ - Carbide	63-65
Holesaws - SHOCKWAVE™ IMPACT DUTY	74

FASTENING

Bit Holders - SHOCKWAVE™ IMPACT DUTY	91-92
Nails and Staples	103
Screwdriving Attachments	93-94
Screwdriving Bits	94-95

Screwdriving Bits - SHOCKWAVE™ IMPACT DUTY	85-90
Sockets & Adaptors - SHOCKWAVE™ IMPACT DUTY	96-102

SAWING, CUTTING AND GRINDING

CUTTING AND GRINDING

Coated Abrasives

Belts	151
Orbital/ Random Orbital Delta Sheets	149-150

Diamond Technology

Diamond Blades	136-141
Diamond Grinding Cup Wheels	142

Grinding

Fixtec Nuts	148
Flap Discs	147
Metal Cutting Grinding Discs	144-146

Sawing

Bandsaw Blades	134-135
----------------	---------

Circular Saw Blades

Metal	133
Wood / Alu	130-132

HACKZALL™ Blades

Jigsaw Blades	119
---------------	-----

Metal

Special Applications	126
Wood	122-123

Multitool Accessories

Starlock Reception - Multi Tool Accessories	127-129
---	---------

SAWZALL™ Blades

Bi-Metal: Demolition / Wood	110
Bi-Metal: Metal	112-115
Bi-Metal: Multimaterial	111
Carbide Technology: Metal / Multi Material / Wood	106-109
Special Application Blades & Sets	116-118

TOOL SYSTEM ATTACHMENTS

Angle Grinders	159-160
Bandsaws	166
Biscuit Joiners	166
Cable Cutters	167
Caulk Guns	181
Chucks	157-158
Circular Saws	166
Crimpers	168-172
Diamond Wet Drilling	78
Drain Cleaning	178-180
Dust Absorption Solutions	154, 183 - 184
Electrical Test and Measuring	182
Expansion Tools	175
Fish Tapes M18 FUEL™	173
Heated Jackets	182
Hydraulic Pump	174
Impact Wrenches	156
Knockout Punch	174
Nibblers	161
Outdoor Products	167-168
Planers	167

Plate Shears	199
Polishers	162-163
Press Tools	176-177
Rotary hammers	152-153
Routers	167
Sanders	164-165
Screwdrivers	155-156
Straight Die Grinders	161

HAND TOOLS

Cutting

Bolt Cutters	212
Cable Cutter	211
Knives and Blades	203-206
Metal Snips	209
Sawing	207-208
Scissors	199
Tubing Cutters	209-210

Demolition

Nail Puller	213
Pry Bars	234
Trim puller	213
Wrecking bar	214

Fish Tape

Fish Tape	234
-----------	-----

Gripping and Fastening

HOLLOWCORE™ Magnetic Nut Drivers	233
Pliers	220-225
Ratchets	230-231
Screwdrivers	215-219
Sockets	228-229
Spanners	226-227
TORQUE LOCK™ Clamps	225
TORQUE LOCK™ Pliers	224
Wrenches	231-233

Hammers

Club Hammer	214
Curved Hammer	214

Hook & Pick Set

Hook & Pick Set	234
-----------------	-----

Measuring and Marking

Chalk Reel	200
Folding Rules	190
Framing Square	200
INKZALL™ Markers	201-202
Levels	192-199
Long Tapes	191
Rafter Square	200
Short Tapes	186-190

Storage and Safety Equipment

Backpacks	257-258
Gloves	240-245
Heavy Duty Boxes	260
Hi-Vis Vests	238-239
PACKOUT™ Storage	248-256
Safety Glasses	236-237
Tool Lanyards	246-247
Work belts	259

MERCHANDISING SOLUTIONS

1m Rows	264-289
Red Racks	290-293



Nothing but **HEAVY DUTY**.™



4x

LIFE IN REBAR*

*Vs Standard 2 cutter drill bit

At MILWAUKEE®, we strive to do things better. To make life easier in the toughest working conditions. We pour our energy into the relentless improvement of our products, and even the most minor improvements begin with understanding the challenges of the jobsite.

This intrinsic understanding of the challenge has led to the creation of our next generation MX4™, a game-changer in drill bit technology. Solid carbide construction means longer life, Target Tip Technology and a shaper angled tip means greater accuracy and next level speed in drilling through the toughest materials.

MX4™ is the benchmark in SDS-Plus and SDS-Max drill bits. Because at MILWAUKEE®, every bit matters.



TiD-extra
Industrial Technologies d.o.o.

NEW



TARGET TIP TECHNOLOGY

IMPROVED PERFORMANCE ON REBAR



FULL CARBIDE TIP*

FOR BEST PERFORMANCE

*≤10MM



SHARPER ANGLED TIP

IMPROVED REBAR PERFORMANCE

116 HOLES PER CHARGE*

* at a depth of 50mm with a 6mm MX4 drill bit, using a 5.5amp High output battery.

PRECISION GERMAN ENGINEERING

4 VARIABLE FLUTE DESIGN

FOR FASTER DRILLING



PGM RATED

FOR PRECISE DRILLING

NEW TARGET TIP TECHNOLOGY

SDS-Plus MX4 drill bits - 4 cut

NEW

Symmetrical 4 cutter geometry (4 x 90°). Perfect round holes for optimal anchor fitting
 New sharper angled tip design for easy spot drilling with pinpoint accuracy and increased performance on rebar
 One piece solid full welded carbide tip on 5-10 mm and one piece slotted carbide tip on 12-32 mm for best lifetime
 4 flute geometry: The high volume 4 flute geometry ensures the optimum removal of dust and debris
 PGM rated
 Made in Germany

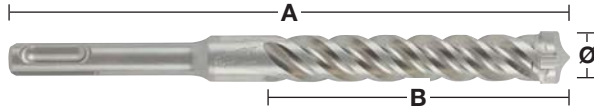
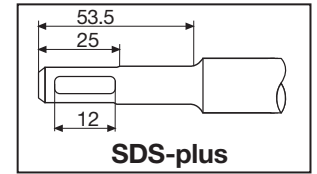

Diameter (mm)	Total length (mm) A	Working length (mm) B	Pre-drill	Pack quantity	Min. order quantity	Article Number	EAN Code
5	115	50		1	1	4932352007	4002395366644
5	165	100		1	1	4932352008	4002395368891
5	215	150		1	1	4932478465	4058546346560
5	265	200		1	1	4932478466	4058546346577
5	315	250		1	1	4932478467	4058546346584
5.5	115	50		1	1	4932352009	4002395368907
5.5	165	100		1	1	4932352010	4002395368914
5.5	215	150		1	1	4932478469	4058546346607
5.5	315	250		1	1	4932478470	4058546346614
6	115	50		1	1	4932352011	4002395368921
6	165	100		1	1	4932352012	4002395368938
6	215	150		1	1	4932352013	4002395366705
6	265	200		1	1	4932352014	4002395366712
6	315	250		1	1	4932352015	4002395366729
6.5	165	100		1	1	4932430146	4002395378074
6.5	215	150		1	1	4932352016	4002395366736
6.5	265	200		1	1	4932352017	4002395366743
6.5	315	250		1	1	4932352018	4002395366750
6.5	465	400		1	1	4932464596	4058546225414
7	115	50		1	1	4932352019	4002395366767
7	165	100		1	1	4932352020	4002395366774
8	115	50		1	1	4932352021	4002395366781
8	165	100		1	1	4932352022	4002395366798
8	215	150		1	1	4932352023	4002395366804
8	265	200		1	1	4932352024	4002395366811
8	315	250		1	1	4932352712	4002395373703
8	465	400	✓	1	1	4932352713	4002395373710
9	165	100		1	1	4932352944	4002395376025
10	115	50		1	1	4932352025	4002395366828
10	165	100		1	1	4932352026	4002395366835
10	215	150		1	1	4932352027	4002395366842
10	265	200		1	1	4932352028	4002395366859
10	315	250		1	1	4932352029	4002395366866
10	455	390	✓	1	1	4932352030	4002395366873
10	600	540	✓	1	1	4932352945	4002395376032
10	1000	940	✓	1	1	4932352946	4002395376049
12	160	100		1	1	4932352031	4002395366880
12	210	160		1	1	4932352032	4002395366897
12	260	210		1	1	4932352033	4002395366903
12	310	250		1	1	4932352034	4002395366910
12	450	400	✓	1	1	4932352035	4002395366927
12	600	540	✓	1	1	4932352947	4002395376056
12	1000	940	✓	1	1	4932352948	4002395376063
14	160	110		1	1	4932352036	4002395366934
14	210	150		1	1	4932352037	4002395366941
14	260	200		1	1	4932352949	4002395376070
14	310	250		1	1	4932352038	4002395366958

✓ Pre drill with a short drill bit of the same diameter.

SDS-Plus MX4 drill bits - 4 cut

NEW

Diameter (mm)	Total length (mm) A	Working length (mm) B	Pre-drill	Pack quantity	Min. order quantity	Article Number	EAN Code
14	380	330		1	1	4932478473	4058546346645
14	450	400	✓	1	1	4932352039	4002395366965
14	600	540	✓	1	1	4932352950	4002395376087
14	1000	940	✓	1	1	4932352951	4002395376094
15	160	100		1	1	4932430725	4002395383863
15	260	200		1	1	4932352952	4002395376100
16	160	100		1	1	4932430726	4002395383870
16	210	150		1	1	4932352953	4002395376117
16	260	200	✓	1	1	4932352819	4002395374779
16	310	250		1	1	4932352954	4002395376124
16	450	400	✓	1	1	4932352820	4002395374786
16	600	540	✓	1	1	4932352955	4002395376131
16	1000	940	✓	1	1	4932352956	4002395376148
17	210	150		1	1	4932478474	4058546346652
18	250	200		1	1	4932356502	4002395320950
18	450	400	✓	1	1	4932356503	4002395320967
20	250	200		1	1	4932356504	4002395320974
20	450	400	✓	1	1	4932356505	4002395320981
22	250	200		1	1	4932399332	4002395359608
22	450	400	✓	1	1	4932356506	4002395320998
24	250	200		1	1	4932356507	4002395321001
24	450	400	✓	1	1	4932356508	4002395321018
25	250	200		1	1	4932399333	4002395359615
25	450	400	✓	1	1	4932356509	4002395321025
28	250	200		1	1	4932399334	4002395359622
28	450	400	✓	1	1	4932356510	4002395321032
30	250	200		1	1	4932399335	4002395359639
30	450	400	✓	1	1	4932356511	4002395321049
32	450	400	✓	1	1	4932399336	4002395359646

✓ Pre drill with a short drill bit of the same diameter.

SDS-Plus MX4 drill bits - 4 cut / 10 pack

NEW

Diameter (mm)	Total length (mm) A	Working length (mm) B	Pack quantity	Min. order quantity	Article Number	EAN Code
5	115	50	10	1	4932352040	4002395366972
5	165	100	10	1	4932471250	4058546288785
5.5	115	50	10	1	4932471251	4058546288792
5.5	165	100	10	1	4932352041	4002395366989
6	115	50	10	1	4932352042	4002395366996
6	165	100	10	1	4932352043	4002395367009
6	215	150	10	1	4932430234	4002395378951
6	265	200	10	1	4932471252	4058546288808
6.5	215	150	10	1	4932430235	4002395378968
6.5	265	200	10	1	4932459588	4058546027605
7	165	100	10	1	4932352044	4002395367016
8	115	50	10	1	4932352045	4002395367023
8	165	100	10	1	4932352046	4002395367030
8	215	150	10	1	4932464872	4058546228170
8	265	200	10	1	4932471253	4058546288815
10	165	100	10	1	4932352047	4002395367047
10	215	150	10	1	4932352048	4002395367054
10	265	200	10	1	4932471254	4058546288822
10	315	250	10	1	4932471255	4058546288839
12	160	100	10	1	4932352049	4002395367061
12	210	150	10	1	4932352050	4002395367078
12	260	200	10	1	4932471256	4058546288846
14	210	150	10	1	4932471257	4058546288853
16	260	200	10	1	4932471258	4058546288860

SDS-Plus MX4 drill bits - 4 cut / 50 pack
NEW

Diameter (mm)	Total length (mm) A	Working length (mm) B	Pack quantity	Min. order quantity	Article Number	EAN Code
5.5	165	100	50	1	4932472234	4058546326302
6	115	50	50	1	4932430437	4002395380985
6	165	100	50	1	4932430438	4002395380992
6	215	150	50	1	4932430462	4002395381234
6.5	215	150	50	1	4932430463	4002395381241
6.5	265	200	50	1	4932459589	4058546027612
7	115	50	50	1	4932472154	4058546325503
7	165	100	50	1	4932472155	4058546325510
8	165	100	50	1	4932430439	4002395381005
8	215	150	50	1	4932430440	4002395381012
8	315	250	50	1	4932472156	4058546325527
8	465	400	50	1	4932472157	4058546325534
10	165	100	50	1	4932430441	4002395381029
10	215	150	50	1	4932430442	4002395381036
10	315	250	50	1	4932472158	4058546325541
10	455	390	50	1	4932472159	4058546325558
12	160	100	50	1	4932472160	4058546325565
12	210	150	50	1	4932430443	4002395381043
12	310	250	50	1	4932472161	4058546325572
12	450	400	50	1	4932472162	4058546325589
14	210	150	50	1	4932478097	4058546340308

SDS-Plus MX4 drill bits - 4 cut / sets
NEW

Description	Supplied in	Pack quantity	Min. order quantity	Article Number	EAN Code
SDS-Plus MX4 drill bit set (5pc)					
① Ø 5 / 6 x 115 mm, Ø 6 / 8 x 165 mm, Ø 10 x 165 mm	Plastic container	5	1	4932352833	4002395374915
SDS-Plus MX4 drill bit set (5pc)					
① Ø 5.5 x 115 mm, Ø 5.5 / 6 / 7 / 8 x 165 mm	Plastic container	5	1	4932352835	4002395374939
SDS-Plus MX4 drill bit set (7pc)					
② Ø 5 / 6 x 115 mm, Ø 6 / 8 / 8 / 10 x 165 mm, Ø 12 x 160 mm	Plastic cassette	7	1	4932478626	4058546348199
SDS-Plus MX4 drill bit set (7pc)					
② Ø 5.5 / 6 x 115 mm, Ø 5 / 5.5 / 6 / 8 / 10 x 165 mm	Plastic cassette	7	1	4932478627	4058546348205
Counter display SDS-Plus MX4 drill bit set (7pc)					
③ 6 x SDS-Plus MX4 7pc set (4932478626)	Plastic cassette	6	1	4932478673	4058546348663
Counter display SDS-Plus MX4 drill bit set (7pc)					
③ 6 x SDS-Plus MX4 7pc set (4932478627)	Plastic cassette	6	1	4932478674	4058546348670





Nothing but **HEAVY DUTY.**[™]



PROFESSIONAL

FAST DRILLING IN CONCRETE

TiD-extra
Industrial Technologies



25%
FASTER

3 BREAKER POINTS

*vs. previous generation



2
VARIABLE
FLUTE
DESIGN



2
CUTTER

IDEAL IN CONCRETE
DRILLING APPLICATIONS
WITH CORDLESS HAMMERS



SDS-Plus M2 drill bits - 2 cut

Made in Germany

FASTEST: New aggressive tip geometry with 3 chip breakers demolishes the concrete quicker and a tapered shoulder design minimises friction enabling the M2 drill bit to deliver faster drilling speed

DURABILITY: Rebar chamfers on the tip prevent side tip damage when hitting metal reinforcement and a thicker core body ensures higher power transfer, lower vibrations and less flute breakages

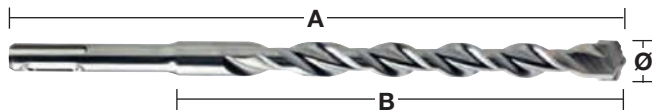
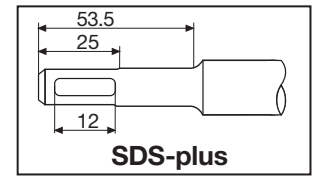

Diameter (mm)	Total length (mm) A	Working length (mm) B	Pre-drill	Pack quantity	Min. order quantity	Article Number	EAN Code
3	110	50		1	1	4932352892	4002395375509
3.5	110	50		1	1	4932373908	4002395353378
4	110	50		1	1	4932339498	4002395304561
4	160	100		1	1	4932399143	4002395357505
4.8	110	50		1	1	4932352130	4002395367832
5	110	50		1	1	4932307067	4002395308835
5	160	100		1	1	4932399315	4002395359431
5	210	150		1	1	4932399316	4002395359448
5.5	110	50		1	1	4932339499	4002395304578
5.5	160	100		1	1	4932340408	4002395311910
5.5	210	150		1	1	4932399317	4002395359455
5.5	260	200		1	1	4932399318	4002395359462
5.5	310	250		1	1	4932399319	4002395359479
5.5	410	350		1	1	4932399320	4002395359486
6	110	50		1	1	4932307068	4002395308842
6	160	100		1	1	4932307069	4002395308859
6	210	150		1	1	4932373136	4002395346394
6	260	200		1	1	4932353819	4002395320127
6	310	250		1	1	4932399321	4002395359493
6	460	400	✓	1	1	4932399322	4002395359509
6.5	110	50		1	1	4932344292	4002395312276
6.5	160	100		1	1	4932344293	4002395312269
6.5	210	150		1	1	4932399147	4002395357574
6.5	260	200		1	1	4932399148	4002395357581
6.5	310	260		1	1	4932399323	4002395359516
7	110	50		1	1	4932353820	4002395320134
7	160	100		1	1	4932340409	4002395311927
7	210	150		1	1	4932399222	4002395358366
7	250	200		1	1	4932399324	4002395359523
8	110	50		1	1	4932307070	4002395308866
8	160	100		1	1	4932307071	4002395308873
8	210	150		1	1	4932307072	4002395308880
8	260	200		1	1	4932353821	4002395320141
8	310	250		1	1	4932399325	4002395359530
8	400	350		1	1	4932399326	4002395359547
8	460	400	✓	1	1	4932367013	4002395336692
8	600	540	✓	1	1	4932399327	4002395359554
8	1000	940	✓	1	1	4932399328	4002395359561
9	160	100		1	1	4932353823	4002395320165
9	210	150		1	1	4932353822	4002395320158
10	110	50		1	1	4932340410	4002395311934
10	160	100		1	1	4932307073	4002395308897
10	210	150		1	1	4932307074	4002395308903
10	260	200		1	1	4932344295	4002395312252
10	310	250		1	1	4932353824	4002395320172
10	450	400	✓	1	1	4932344296	4002395312245
10	600	550	✓	1	1	4932367014	4002395336708
10	1000	950	✓	1	1	4932367015	4002395336715

✓ Pre drill with a short drill bit of the same diameter.

SDS-Plus M2 drill bits - 2 cut



Diameter (mm)	Total length (mm) A	Working length (mm) B	Pre-drill	Pack quantity	Min. order quantity	Article Number	EAN Code
11	160	100		1	1	4932367066	4002395336722
11	260	210		1	1	4932399329	4002395359578
12	160	110		1	1	4932307075	4002395308910
12	210	160		1	1	4932307076	4002395308927
12	260	210		1	1	4932344297	4002395312238
12	310	260		1	1	4932353825	4002395320189
12	450	400	✓	1	1	4932307077	4002395308934
12	600	550	✓	1	1	4932367068	4002395336746
12	1000	950	✓	1	1	4932367017	4002395336760
13	160	110		1	1	4932307946	4002395309054
13	260	210		1	1	4932344298	4002395312221
14	160	110		1	1	4932307078	4002395308941
14	210	160		1	1	4932353826	4002395320196
14	260	210		1	1	4932307079	4002395308958
14	310	260		1	1	4932399330	4002395359585
14	450	400	✓	1	1	4932307088	4002395309047
14	600	550	✓	1	1	4932367018	4002395336777
14	1000	950	✓	1	1	4932367019	4002395336784
15	160	110		1	1	4932373910	4002395353392
15	260	210		1	1	4932344300	4002395312207
16	160	110		1	1	4932307080	4002395308965
16	210	160		1	1	4932307081	4002395308972
16	260	210		1	1	4932399331	4002395359592
16	310	260		1	1	4932344301	4002395312191
16	450	400	✓	1	1	4932307082	4002395308989
16	600	550	✓	1	1	4932367069	4002395336791
16	1000	950	✓	1	1	4932367021	4002395336814
18	200	150		1	1	4932344303	4002395312177
18	250	200		1	1	4932307083	4002395308996
18	300	250		1	1	4932344304	4002395312160
18	450	400	✓	1	1	4932340411	4002395311941
18	600	550	✓	1	1	4932367022	4002395336821
18	1000	950	✓	1	1	4932367024	4002395336845
20	200	150		1	1	4932344305	4002395312153
20	250	200		1	1	4932307084	4002395309009
20	300	250		1	1	4932399027	4002395356126
20	450	400	✓	1	1	4932307085	4002395309016
20	600	550	✓	1	1	4932367025	4002395336876
20	1000	950	✓	1	1	4932367026	4002395336883
22	250	200		1	1	4932373911	4002395353408
22	450	400	✓	1	1	4932344307	4002395312139
22	600	550	✓	1	1	4932367027	4002395336890
22	1000	950	✓	1	1	4932367029	4002395336913
24	250	200		1	1	4932373922	4002395353521
24	450	400	✓	1	1	4932307087	4002395309030
25	250	200		1	1	4932344308	4002395312122
25	450	400	✓	1	1	4932344309	4002395312115
25	1000	950	✓	1	1	4932367030	4002395336975
26	250	200		1	1	4932344310	4002395323814
26	450	400	✓	1	1	4932344311	4002395312092

✓ Pre drill with a short drill bit of the same diameter.

SDS-Plus M2 drill bits - 2 cut / counter displays



Description	Pack quantity	Min. order quantity	Article Number	EAN Code
① Counter display 10 x 7 pc SDS-Plus M2 drill bit set (4932352339)	10	1	4932352341	4002395370009
② Counter display 10 x 10 pc SDS-Plus M2 drill bit set (4932352340)	10	1	4932352342	4002395370016



SDS-Plus M2 drill bits - 2 cut / 10 pack

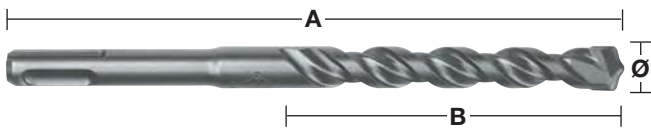

Diameter (mm)	Total length (mm) A	Working length (mm) B	Pack quantity	Min. order quantity	Article Number	EAN Code
5	110	50	10	1	4932371702	4002395344017
5	160	100	10	1	4932352520	4002395371785
5.5	110	50	10	1	4932352521	4002395371792
5.5	160	100	10	1	4932371703	4002395344024
6	110	50	10	1	4932371704	4002395344031
6	160	100	10	1	4932371705	4002395344048
6	210	150	10	1	4932399337	4002395359653
6.5	160	100	10	1	4932399338	4002395359660
6.5	210	150	10	1	4932399339	4002395359677
6.5	260	200	10	1	4932399340	4002395359684
7	160	100	10	1	4932373225	4002395348619
8	160	100	10	1	4932371706	4002395344055
8	210	150	10	1	4932399341	4002395359691
10	110	50	10	1	4932352522	4002395371808
10	160	100	10	1	4932371708	4002395344079
10	210	150	10	1	4932371709	4002395344086
10	260	200	10	1	4932399342	4002395359707
12	160	100	10	1	4932399343	4002395359714
12	210	160	10	1	4932371710	4002395344093
12	260	210	10	1	4932399344	4002395359721
14	260	210	10	1	4932371711	4002395344109

SDS-Plus M2 drill bits - 2 cut / 50 pack



Diameter (mm)	Total length (mm) A	Working length (mm) B	Pack quantity	Min. order quantity	Article Number	EAN Code
5	110	50	50	1	4932399176	4002395357833
5.5	160	100	50	1	4932399177	4002395357840
6	110	50	50	1	4932399178	4002395357857
6	160	100	50	1	4932399179	4002395357864
7	160	110	50	1	4932399181	4002395357888
8	160	100	50	1	4932399182	4002395357895
8	210	150	50	1	4932399183	4002395357901
10	160	110	50	1	4932399345	4002395359738
10	210	150	50	1	4932399184	4002395357918
10	260	200	50	1	4932399185	4002395357925
12	210	160	50	1	4932399186	4002395357932

SDS-Plus M2 drill bits - 2 cut / cassettes



Description	Pack quantity	Min. order quantity	Article Number	EAN Code
① SDS-Plus M2 drill bit set (5pc) Ø 5 / 6 x 110 mm and Ø 6 / 8 / 10 x 160 mm	5	1	4932352338	4002395369973
① SDS-Plus M2 drill bit set (5pc) Ø 5.5 x 110 mm and Ø 5.5 / 6 / 7 / 8 x 160 mm	5	1	4932352834	4002395374922
① SDS-Plus M2 drill bit set (5pc) Ø 10 / 12 / 14 / 16 / 20 x 450 mm	5	1	4932352801	4002395374595
② SDS-Plus M2 drill bit set (7pc) Ø 5 / 6 / 8 x 110 mm and Ø 6 / 8 / 10 / 12 x 160 mm	7	1	4932352339	4002395369980
③ SDS-Plus M2 drill bit set (10pc) Ø 5 / 6 / 6 x 110 mm and Ø 6 / 6 / 8 / 8 / 10 / 12 / 14 x 160 mm	10	1	4932352340	4002395369997
④ Drill bit and chisel set (5pc) SDS-Plus drill bits Ø 6 / 8 / 10 x 160 mm, pointed and flat chisel	5	1	4932430002	4002395376636





Nothing but **HEAVY DUTY.**[™]

INVESTMENT IN CARBIDE



TiD-extra
Industrial Technologies d.o.o.

RESEARCH DEVELOPMENT
NEW TECHNOLOGIES

PROTOTYPING
RAPID PROTOTYPING



TESTING
COMPREHENSIVE TESTING

PRODUCTION
BEST IN CLASS PRODUCTION



SDS-PLUS

SDS-MAX

CHISELS



MADE IN GERMANY

SDS-Plus TCT multipurpose drill bits

These drill bits will drill in metal, wood and stone but in rotary mode only.
 Hammer action cannot be used with these drill bits.
 Ideal for tradesmen who need to drill through a variety of materials in one go.
 Made in Germany.

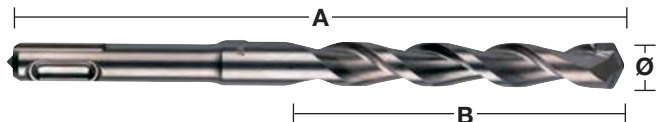

Diameter (mm)	Total length (mm) A	Working length (mm) B	Pack quantity	Min. order quantity	Article Number	EAN Code
6	160	100	1	1	4932373918	4002395353484
8	210	150	1	1	4932373919	4002395353491
10	260	200	1	1	4932373920	4002395353507
12	260	200	1	1	4932373921	4002395353514

SDS-Plus extensions

Universal SDS-Plus extensions to extend the reach of SDS-Plus drill bits.
 Tool free drill bit click & connect system.
 Fits to all SDS-Plus rotary hammers and drill bits.
 Optimal for drilling around obstructions such as previously installed pipes and for overhead drilling.
 Allows deep hole drilling e.g. rebar applications without buying an expensive long drill bit.



Length (mm)	Pack quantity	Min. order quantity	Article Number	EAN Code
300	1	1	4932471153	4058546287818
450	1	1	4932471154	4058546287825

SDS-Plus dustless drill bits - 4 cut - One piece design

Faster and more efficient drill bit due to effective dust removal.
 Efficient drilling without dust for a safer and cleaner working environment.
 Active drill bit head cooling for a longer life.
 4 cutter design prevents the drill bit from jamming into the rebar.
 Accurate concentricity and high dimensional accuracy drilled holes, according to PGM Conformity.
 Universal connector for all common vacuum cleaners with hose diameter 32 – 38 mm.

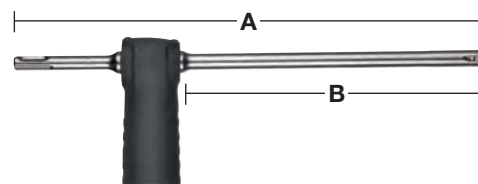

Diameter (mm)	Total length (mm) A	Working length (mm) B	Pack quantity	Min. order quantity	Article Number	EAN Code
12	325	200	1	1	4932459283	4058546002497
14	360	240	1	1	4932459284	4058546002503
16	360	240	1	1	4932459285	4058546002510
18	360	240	1	1	4932459286	4058546002527
Universal vacuum cleaner adaptor			1	1	4931416173	4002395805501

SDS-Plus TCT core cutters

Core cutters for rotary hammers up to 4 kg.
 All TCT cores have a M16 x 2 thread and fit to both SDS-Plus and Hex 11 arbors.
 Arbor and pilot drill bit required additionally.
 Made in Germany.
 Not suitable for reinforced concrete.

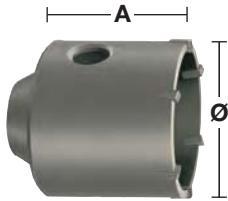
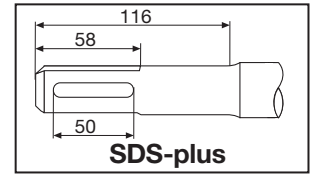

Diameter (mm)	Total length (mm) A	Pack quantity	Min. order quantity	Article Number	EAN Code
35	58	1	1	4932344478	4002395312559
50	58	1	1	4932344479	4002395312566
65	50	1	1	4932344480	4002395312573
68	50	1	1	4932399099	4002395357031
82	50	1	1	4932344481	4002395312580
90	50	1	1	4932344482	4002395312597

SDS-Plus TCT core cutter - set

Set version includes: TCT core cutter, SDS-Plus arbor 105 mm length, TCT pilot drill bit Ø 8 x 120 mm and allen key.

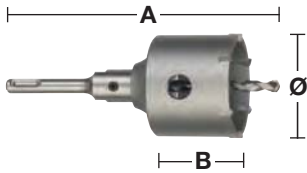

Diameter (mm)	Total length (mm) A	Working length (mm) B	Pack quantity	Min. order quantity	Article Number	EAN Code
65	182	50	4	1	4932399295	4002395359097
68	182	50	4	1	4932399296	4002395359103
82	182	50	4	1	4932399297	4002395359110

SDS-Plus TCT core cutter arbors

Both SDS-Plus and Hex arbors include an allen key and require a pilot drill bit additionally.

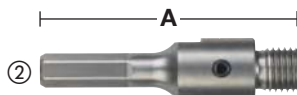
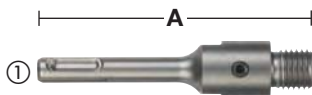

Description	Reception	Diameter (mm)	Total length (mm) A	Pack quantity	Min. order quantity	Article Number	EAN Code
① SDS-plus arbor	SDS-Plus		105	2	1	4932399966	4002395366255
① SDS-plus arbor	SDS-Plus		370	2	1	4932399967	4002395366262
② Hex arbor	11 mm Hex		90	2	1	4932399968	4002395366279
③ TCT pilot drill bit for use in masonry, concrete, brick etc.		8	120	1	1	4932399125	4002395357291



DRILL TO THE MAX.

SDS-MAX MX4™ DRILL BITS

Milwaukee® Tool leads the way in accessories development and technology for the professional job site. Our relentless pursuit of innovation has resulted in the Next Generation MX4™ SDS-MAX drill bits, our most powerful and durable drill bit for toughest tasks on the job site.

Driven and developed by countless hours on the jobsite, MILWAUKEE® has created MX4™ SDS-MAX as a drill bit designed to offer the fastest performance and longest lifespan when drilling in reinforced concrete. Featuring MILWAUKEE® exclusive Target Tip Technology, SDS-MAX is larger than the standard SDS-PLUS bits, providing improved accuracy and performance in rebar as well as other heavy-duty applications.



TiD-extra
Industrial Technologies d.o.o.

NEW



TARGET TIP TECHNOLOGY



SHARPER ANGLED TIP
IMPROVED REBAR PERFORMANCE

2X

LIFE IN REBAR*

* Vs previous generation

4 VARIABLE FLUTE DESIGN*

FOR FASTER DRILLING

PRECISION GERMAN ENGINEERING

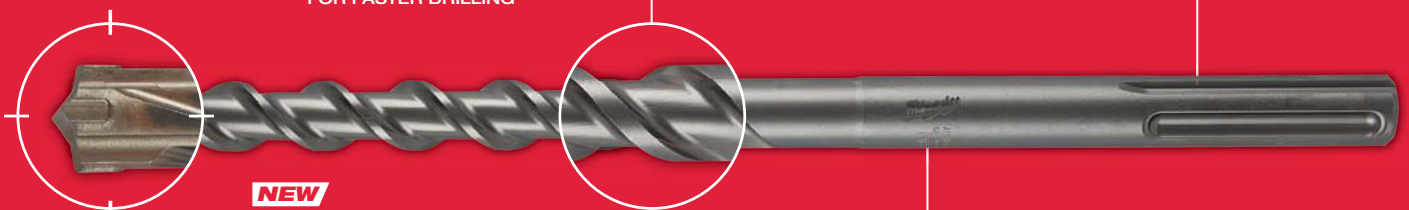

NEW



TARGET TIP TECHNOLOGY



PGM RATED

FOR PRECISE DRILLING

*Variable 4 flute design for diameters up to 16mm, all larger diameters have a variable 2 flute design.

SDS-Max MX4 drill bits - 4 cut

NEW

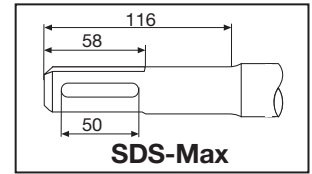
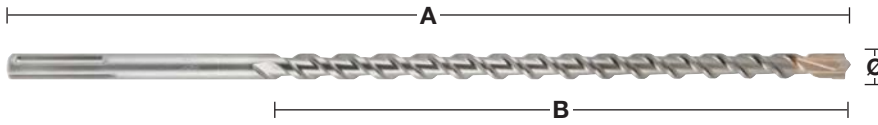

Diameter (mm)	Total length (mm) A	Working length (mm) B	Pre-drill	Pack quantity	Min. order quantity	Article Number	EAN Code
12	340	200		1	1	4932352750	4002395374083
12	540	400	✓	1	1	4932352751	4002395374090
12	690	550		1	1	4932430727	4002395383887
14	340	200		1	1	4932352752	4002395374106
14	540	400	✓	1	1	4932352753	4002395374113
15	340	200		1	1	4932352754	4002395374120
15	540	400	✓	1	1	4932352755	4002395374137
16	340	200		1	1	4932352756	4002395374144
16	540	400	✓	1	1	4932352757	4002395374151
16	940	800	✓	1	1	4932352758	4002395374168
16	1320	1180	✓	1	1	4932352759	4002395374175
18	340	200		1	1	4932352760	4002395374182
18	540	400	✓	1	1	4932352761	4002395374199
18	940	800	✓	1	1	4932352762	4002395374205
18	1320	1180	✓	1	1	4932352763	4002395374212
20	320	200		1	1	4932352764	4002395374229
20	520	400	✓	1	1	4932352765	4002395374236
20	920	800	✓	1	1	4932352766	4002395374243
20	1320	1200	✓	1	1	4932352767	4002395374250
22	320	200		1	1	4932352768	4002395374267
22	520	400	✓	1	1	4932352769	4002395374274
22	920	800	✓	1	1	4932352770	4002395374281
22	1320	1200	✓	1	1	4932352771	4002395374298
24	320	200		1	1	4932352772	4002395374304
24	520	400	✓	1	1	4932352773	4002395374311
25	320	200		1	1	4932352774	4002395374328
25	520	400	✓	1	1	4932352775	4002395374335
25	920	800	✓	1	1	4932352776	4002395374342
25	1320	1200	✓	1	1	4932352777	4002395374359
26	520	400		1	1	4932430728	4002395383894
28	370	250		1	1	4932352778	4002395374366
28	570	450	✓	1	1	4932352779	4002395374373
28	670	550	✓	1	1	4932352780	4002395374380
28	920	800	✓	1	1	4932352781	4002395374397
28	1320	1200	✓	1	1	4932352782	4002395374403
30	370	250		1	1	4932352783	4002395374410
30	570	450		1	1	4932352784	4002395374427
30	920	800		1	1	4932430729	4002395383900
32	370	250		1	1	4932352785	4002395374434
32	570	450		1	1	4932352786	4002395374441
32	920	800	✓	1	1	4932352787	4002395374458
32	1320	1200	✓	1	1	4932352788	4002395374465
35	370	250		1	1	4932352789	4002395374472
35	570	450		1	1	4932352790	4002395374489
35	920	800	✓	1	1	4932352791	4002395374496
38	370	250		1	1	4932352792	4002395374502
38	570	450		1	1	4932352793	4002395374519
40	370	250		1	1	4932352794	4002395374526
40	570	450	✓	1	1	4932352795	4002395374533
40	920	800	✓	1	1	4932352796	4002395374540
40	1320	1200	✓	1	1	4932352797	4002395374557
45	570	450		1	1	4932352798	4002395374564
45	920	800		1	1	4932430730	4002395383917
50	570	450		1	1	4932430731	4002395383924
52	570	450		1	1	4932352799	4002395374571
SDS-Max drill bits set (5pc)							
Ø 16 / 18 x 540 mm, Ø 20 / 22 / 25 x 520 mm				5	1	4932352800	4002395374588

✓ Pre drill with a short drill bit of the same diameter.

SDS-Max dustless drill bits - 4 cut - One piece design

Faster and more efficient drilling due to 99% dust removal.
 Efficient drilling without dust for a safer and cleaner working environment.
 Active drill bit head cooling for a longer life.
 4 cutter design prevents the drill bit from jamming in the rebar.
 Accurate concentricity and high dimensional accuracy drilled holes, according to PGM Conformity.
 Universal connector for all common vacuum cleaners with hose diameter 32 – 38 mm.

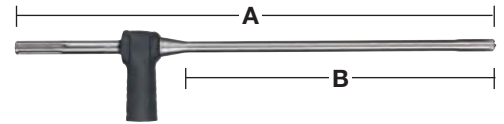

Diameter (mm)	Total length (mm) A	Working length (mm) B	Pack quantity	Min. order quantity	Article Number	EAN Code
16	600	400	1	1	4932459287	4058546002534
18	600	400	1	1	4932459288	4058546002541
20	600	400	1	1	4932459289	4058546002558
22	600	400	1	1	4932459290	4058546002565
24	600	400	1	1	4932459291	4058546002572
25	600	400	1	1	4932459292	4058546002589
28	600	400	1	1	4932459293	4058546002596
28	900	900	1	1	4932459294	4058546002602
30	600	400	1	1	4932459295	4058546002619
30	900	700	1	1	4932459296	4058546002626
32	600	400	1	1	4932459297	4058546002633
32	900	700	1	1	4932459298	4058546002640
35	600	400	1	1	4932459299	4058546002657
35	900	700	1	1	4932459300	4058546002664
Universal vacuum cleaner adaptor			1	1	4931416173	4002395805501



SDS-Max TCT tunnel drill bits - One piece design

One piece solid steel tool.
 Increased lifetime.
 Vario tunnel drill bits (supplied with thread).
 Suitable for all rotary hammers.
 Made in Germany.
 Not suitable for reinforced concrete.

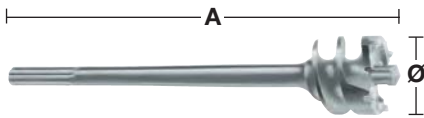
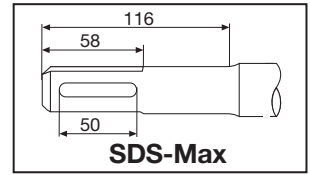

Diameter (mm)	Total length (mm) A	Pack quantity	Min. order quantity	Article Number	EAN Code
45	550	1	1	4932373892	4002395353217
45	990	1	1	4932399366	4002395359837
55	550	1	1	4932373893	4002395353224
55	990	1	1	4932399368	4002395359851
65	550	1	1	4932373894	4002395353231
65	990	1	1	4932399370	4002395359875
80	550	1	1	4932373895	4002395353248
80	990	1	1	4932399372	4002395359899

SDS-Max TCT core cutters - One piece design

One piece solid steel tool.
 Increased lifetime.
 Supplied with pilot drill bit and ejector tool.
 Made in Germany.
 Not suitable for reinforced concrete.

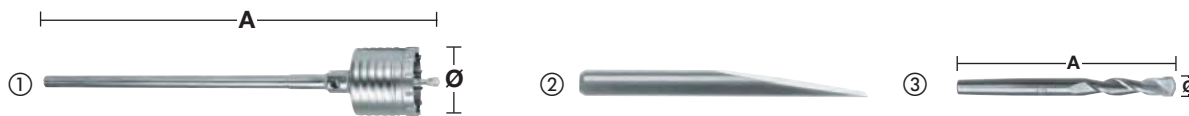

Description	Diameter (mm)	Total length (mm) A	Pack quantity	Min. order quantity	Article Number	EAN Code
①	50	290	1	1	4932399373	4002395359905
	50	550	1	1	4932373884	4002395353132
	68	290	1	1	4932399374	4002395359912
	68	550	1	1	4932373885	4002395353149
	80	290	1	1	4932399375	4002395359929
	80	550	1	1	4932373886	4002395353156
	100	550	1	1	4932373888	4002395353170
	125	550	1	1	4932373889	4002395353187
② Ejector tool			1	1	4932373890	4002395353194
③ Pilot drill bit	11	120	1	1	4932245967	4002395307111

SDS-Max TCT core cutters - Two piece design

Not suitable for rotary hammers > 10 kg.
 Made in Germany.
 Not suitable for reinforced concrete.

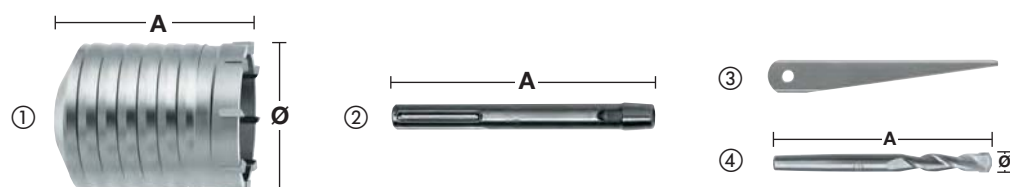

Description	Diameter (mm)	Total length (mm) A	Pack quantity	Min. order quantity	Article Number	EAN Code
①	40	100	1	1	4932245992	4002395307180
	50	100	1	1	4932430732	4002395383931
	60	100	1	1	4932430733	4002395383948
	65	100	1	1	4932245994	4002395307203
	68	100	1	1	4932430734	4002395383955
	80	100	1	1	4932245995	4002395307210
	90	100	1	1	4932430735	4002395383962
	100	100	1	1	4932367304	4002395336432
	125	100	1	1	4932367306	4002395336456
	150	100	1	1	4932367308	4002395336470
② Arbor SDS-Max	-	180	1	1	4932343667	4002395315932
	-	450	1	1	4932343670	4002395315949
③ Ejector tool	-	-	1	1	4932604214	4002395311231
④ Pilot drill bit	11	120	1	1	4932245967	4002395307111

SDS-Max to SDS-Plus chuck adaptor



Description	Tool reception	Drill reception	Pack quantity	Min. order quantity	Article Number	EAN Code
SDS-Max to SDS-Plus chuck adaptor	SDS-Max	SDS-Plus	1	1	4932359490	4002395325795

SDS-Max vario extension system

Flexible tool system: can be extended to variable lengths in combination with core cutters or tunnel bits.

We recommend a maximum of 3 extensions.

Cost effective: different drill sizes can be exchanged easily and fast with the threaded stud system.

Suitable for rotary hammers up to 8 kg.

Vario tunnel bits (supplied with thread).

Not suitable for reinforced concrete.

Description	Diameter (mm)	Total length (mm) A	Pack quantity	Min. order quantity	Article Number	EAN Code
① SDS-Max arbor with internal thread	-	195	1	1	4932430736	4002395383979
② Vario extension (incl. threaded stud)	25	280	1	1	4932430737	4002395383986
③ Vario threaded stud	-	-	1	1	4932430738	4002395383993
④ Vario threaded stud with tapered end 1:8 for TCT core cutters	-	-	1	1	4932430748	4002395384099
⑤ TCT core cutter	40	100	1	1	4932245992	4002395307180
	50	100	1	1	4932430732	4002395383931
	60	100	1	1	4932430733	4002395383948
	65	100	1	1	4932245994	4002395307203
	68	100	1	1	4932430734	4002395383955
	80	100	1	1	4932245995	4002395307210
	90	100	1	1	4932430735	4002395383962
	100	100	1	1	4932367304	4002395336432
	125	100	1	1	4932367306	4002395336456
	150	100	1	1	4932367308	4002395336470
⑥ Ejector tool	-	-	1	1	4932604214	4002395311231
⑦ Pilot drill bit	11	120	1	1	4932245967	4002395307111
⑧ Vario tunnel drill bits (supplied with thread)	30	150	1	1	4932430739	4002395384006
	35	150	1	1	4932430740	4002395384013
	40	150	1	1	4932430743	4002395384044
	45	150	1	1	4932430744	4002395384051
	55	150	1	1	4932430745	4002395384068
	60	150	1	1	4932430741	4002395384020
	68	150	1	1	4932430746	4002395384075
	80	150	1	1	4932430747	4002395384082
	90	150	1	1	4932430742	4002395384037

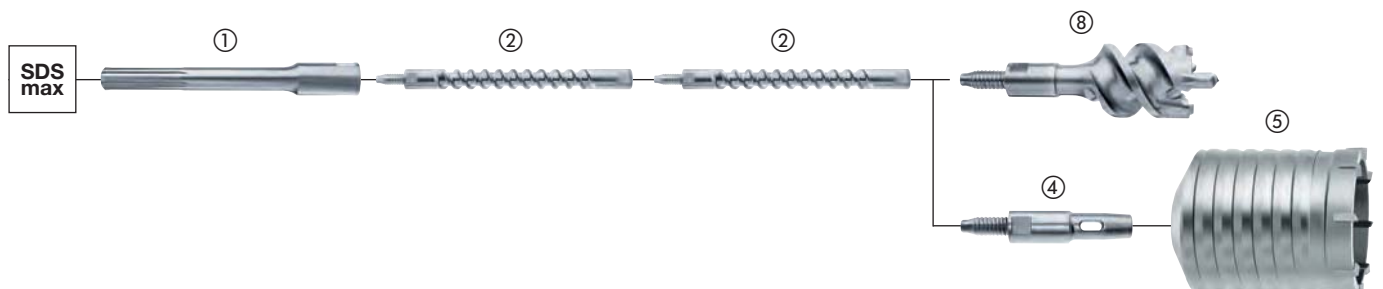
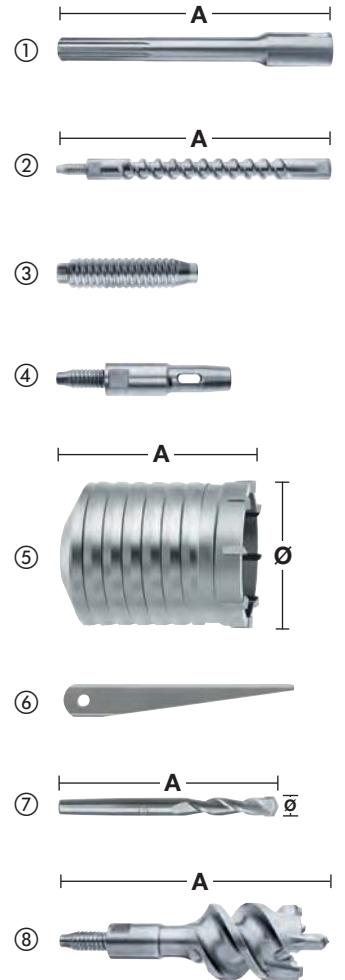

Drill Connect

The innovative and patented Drill Connect System is the ultimate solution for those requiring maximum versatility with large diameter drilling tools.

Versatile:

Drill Connect acts as a link between machine and drilling tools. On one side the system is totally compatible to all SDS-Max reception drilling tools such as drill bits, tunnel bits and core cutters. On the opposite side, between the rotary hammer and the Drill Connect attachment, one can fit the extension piece with the desired length.

Cost effective:

Professional users always require both long and short length drill bits and depending on the application sometimes even of the same diameter. But now, one can reduce the total number of drilling tools with the help of the Drill Connect System which makes it possible to interchange the drilling tools diameter and length in one simple step. Therefore users can reap the benefits of purchasing the cheaper short length drill bits and extending the length with the economical extensions plus the flexibility of Drill Connect reduces the overall quantity of drill bits one must carry in their toolbox.

TiD-extra
Industrial Technologies d.o.o.

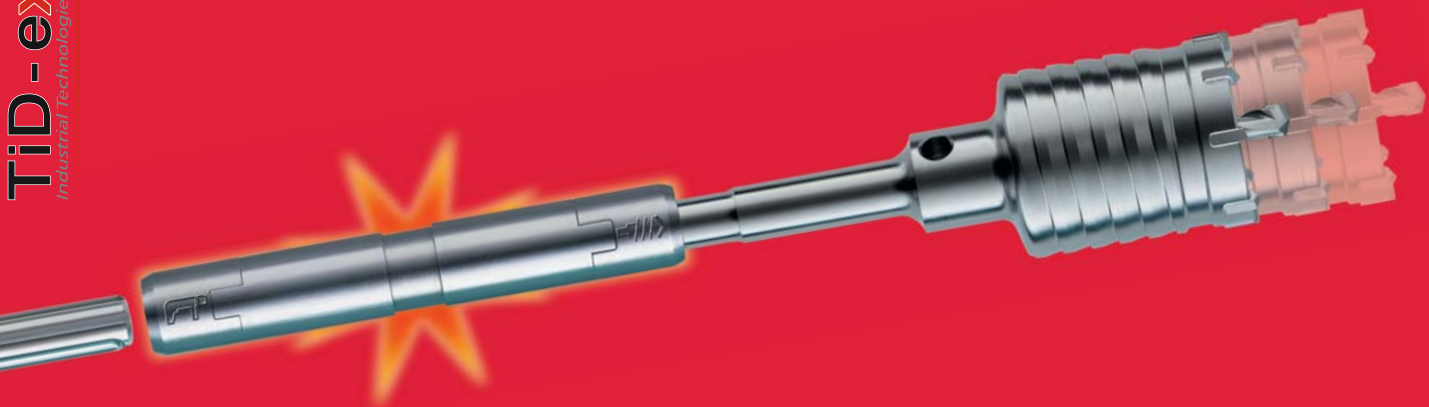

100% Power:

The Drill Connect attachment provides a quick and safe connection between drilling tool and extension piece and therefore ensures that 100% of the power is completely transmitted to the drill bit tip.



Less weight:

The combination of short drilling tools and 18 mm diameter extensions reduces the overall weight by up to 15%.

- We recommend that Drill Connect be cleaned of concrete dust and lubricated with grease at regular intervals (Grease – Part-no. 4932352273).
- Drill Connect is only suitable for drilling tools in excess of 32 mm diameter and limited for use with rotary hammers up to 8 kg in weight.

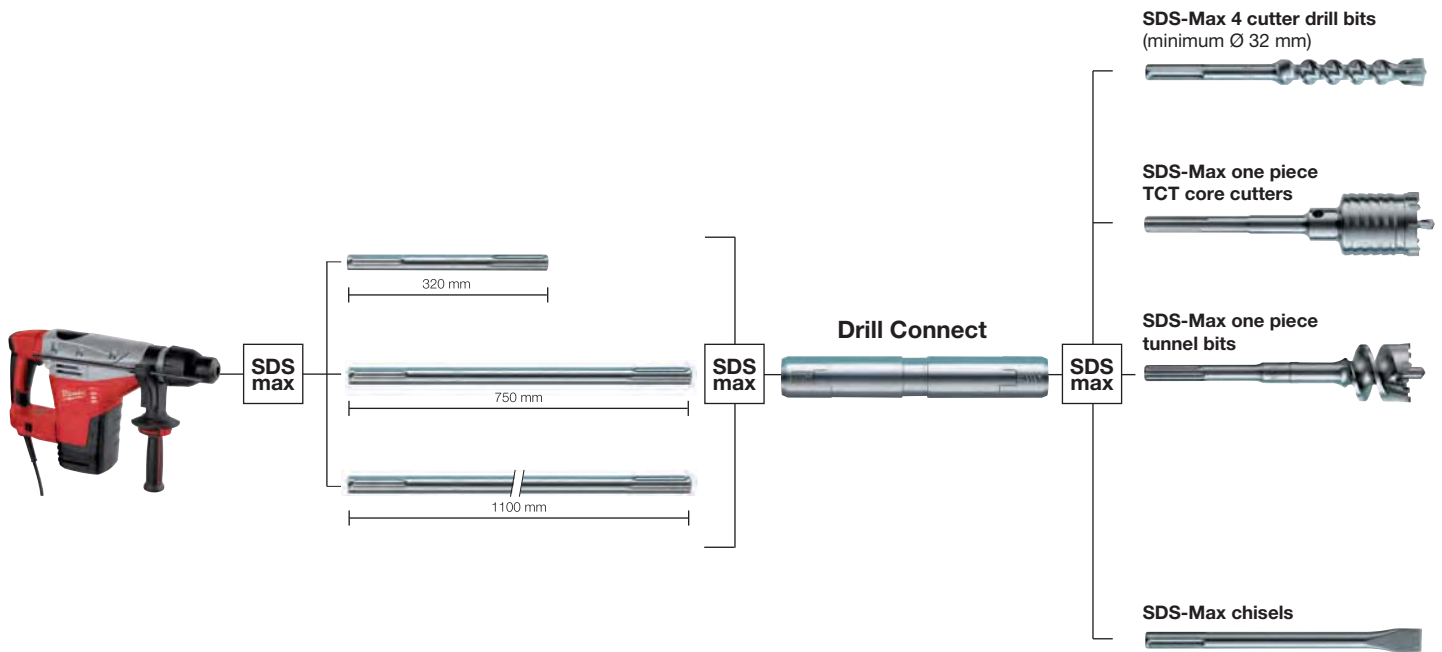

Drill connect

Suitable for use with drilling tools with a Ø of 32 mm and above.
 For use with rotary hammers up to 8 kg in weight.

Description	Tool reception	Drill connect reception	Total length (mm) A	Pack quantity	Min. order quantity	Article Number	EAN Code
Drill connect	SDS-Max	SDS-Max	190	1	1	4932399128	4002395357321

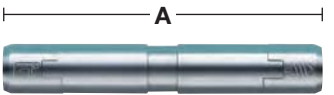

Extension pieces

Description	Tool reception	Drill connect reception	Length (mm) A	Pack quantity	Min. order quantity	Article Number	EAN Code
SDS-Max extension	SDS-Max	SDS-Max	320	1	1	4932399242	4002395358533
SDS-Max extension	SDS-Max	SDS-Max	750	1	1	4932399129	4002395357338
SDS-Max extension	SDS-Max	SDS-Max	1100	1	1	4932399243	4002395358540

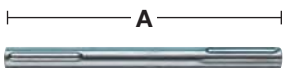

Grease

This grease has been specially formulated to lubricate and protect both the tool and accessories ensuring increased lifetime.
 Apply sparingly directly onto the reception of the drill bit, chisel or core cutter, etc.
 Contains 50 grams.

Description	Pack quantity	Min. order quantity	Article Number	EAN Code
Grease	1	1	4932352273	4002395369324
Counter display with 15 x single grease tube	15	1	4932352274	4002395369331



SLEDGE™ CHISELS

2X
MORE LIFE
 *VS STANDARD CHISELS

Our SLEDGE™ Chisels stay sharper for longer. Reinforced edges deliver maximum durability and reduced wear over the life of the chisel. We've engineered these chisels to maintain sharper edges for increased productivity with an optimized tip for fast removal of concrete, rust, cutting troughs, and asphalt.

No re-sharpening or re-hardening necessary for reduced downtime. High grade forged steel for maximum durability and longer life in concrete demolition over our standard scraping chisels. For use with SDS-Plus & Max rotary hammers.



TiD-extra
 Industrial Technologies d.o.o.

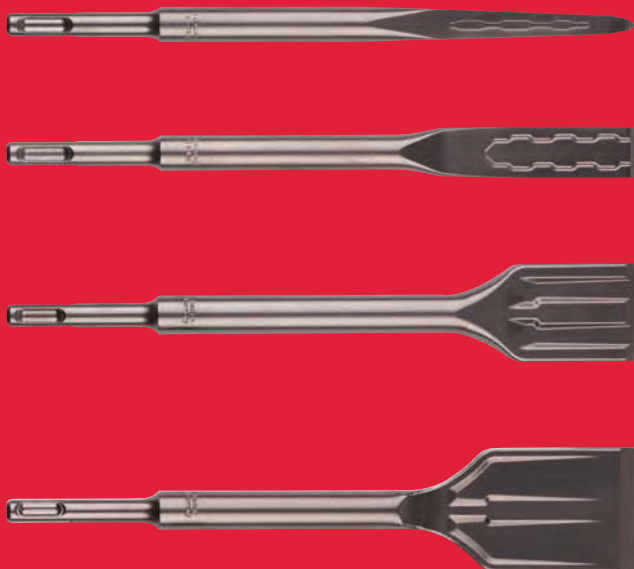

EXTRA LONG
 WORKING LENGTH

SELF-SHARPENING
TIP

MADE IN
GERMANY

RE-GRINDED TIP
 STAYS SHARPER, BEST PERFORMANCE AND AVOIDS JAMMING

SDS-Plus SLEDGE[™] self sharpening chisels

NEW

Up to 2x longer life compared to standard chisels.
 Self-sharpening tip geometry.
 Extra long working length for more material removal.
 Re-grinded tip stays sharper for longer and avoids jamming.
 Made in Germany.

Description	Total length (mm)	Blade width (mm)	Pack quantity	Min. order quantity	Article Number	EAN Code
① SDS-Plus SLEDGE [™] pointed chisel	250	-	1	1	4932478262	4058546344399
			10	1	4932478272	4058546344498
② SDS-Plus SLEDGE [™] flat chisel	250	20	1	1	4932478263	4058546344405
			10	1	4932478273	4058546344504
③ SDS-Plus SLEDGE [™] wide chisel	250	40	1	1	4932478264	4058546344412
④ SDS-Plus SLEDGE [™] tile chisel	250	50	1	1	4932478265	4058546344429



SDS-Max SLEDGE[™] self sharpening chisels

NEW

Up to 2x longer life compared to standard chisels.
 Self sharpening tip geometry.
 Extra long working length for more material removal.
 Re-grinded tip stays sharper for longer and avoids jamming.
 Made in Germany.

Description	Total length (mm)	Blade width (mm)	Pack quantity	Min. order quantity	Article Number	EAN Code
① SDS-Max SLEDGE [™] pointed chisel	400	-	1	1	4932478266	4058546344436
			20	1	4932478274	4058546344511
② SDS-Max SLEDGE [™] flat chisel	400	25	1	1	4932478267	4058546344443
			20	1	4932478275	4058546344528
③ SDS-Max SLEDGE [™] 2 wide chisel	380	50	1	1	4932478268	4058546344450
④ SDS-Max SLEDGE [™] 3 wide chisel	300	80	1	1	4932478269	4058546344467
⑤ SDS-Max SLEDGE [™] tile chisel	380	50	1	1	4932478270	4058546344474
⑥ SDS-Max SLEDGE [™] tile chisel	300	50	1	1	4932478271	4058546344481

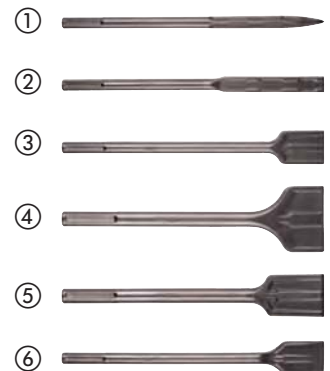

SDS-Plus chisels

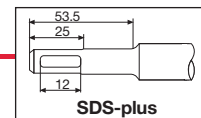

Description	Total length (mm)	Blade width (mm)	Pack quantity	Min. order quantity	Article Number	EAN Code
① SDS-Plus thin pointed chisel	180	-	1	1	4932451731	4002395276813
② SDS-Plus pointed chisel	250	-	1	1	4932339625	4002395304813
③ SDS-Plus thin flat chisel	180	14	1	1	4932451732	4002395276820
④ SDS-Plus flat chisel	250	20	1	1	4932339626	4002395304820
⑤ SDS-Plus wide chisel	250	40	1	1	4932367146	4002395334377
⑥ SDS-Plus 3 pc chisel set: 1 x Pointed chisel, 1 x Flat chisel, 1 x Wide chisel	250	-	3	1	4932430001	4002395376629
⑦ SDS-Plus tile removal chisel	250	40	1	1	4932353424	4002395320202
	250	50	1	1	4932352343	4002395370023
⑧ SDS-Plus gouge chisel	250	22	1	1	4932339627	4002395304837
⑨ SDS-Plus plaster removal chisel	165	75	1	1	4932352344	4002395370030
⑩ SDS-Plus floor / wall scraper	250	100	1	1	4932352919	4002395375776
Spare 1 mm thick floor / wall scraper blade with 3 x bolts / nuts	-	-	1	1	4932352920	4002395375783
⑪ SDS-Plus mortar chisel	125	32	1	1	4932472029	4058546324254
	200	32	1	1	4932472030	4058546324261

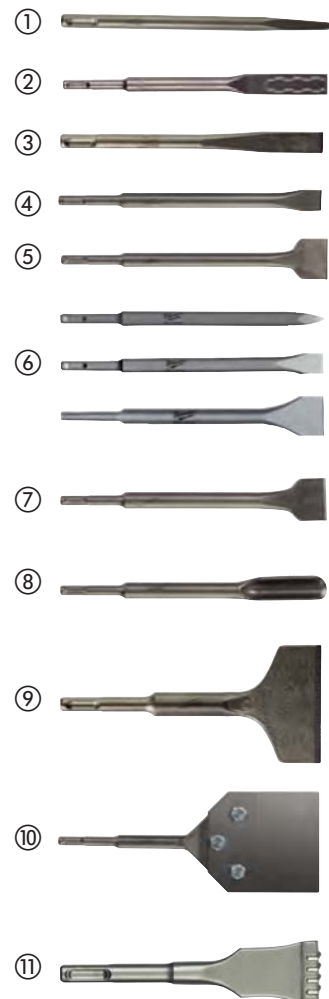

SDS-Max chisels

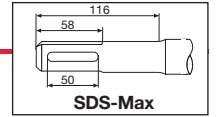

Description	Total length (mm)	Blade width (mm)	Pack quantity	Min. order quantity	Article Number	EAN Code
① SDS-Max pointed chisel	280	-	1	1	4932343734	4002395317509
	400	-	1	1	4932343735	4002395317516
	400	-	20	1	4932399302	4002395359165
	600	-	1	1	4932343736	4002395317523
② SDS-Max flat chisel	280	25	1	1	4932343737	4002395317530
	400	25	1	1	4932343738	4002395317547
	400	25	20	1	4932399303	4002395359172
	600	25	1	1	4932343739	4002395317554
③ SDS-Max wide chisel	400	50	1	1	4932343743	4002395317592
	300	80	1	1	4932343744	4002395317608
④ SDS-Max tile removal chisel	300	115	1	1	4932343745	4002395317615
	300	80	1	1	4932399234	4002395358489
⑤ SDS-Max chasing gouge chisel	300	26	1	1	4932343740	4002395317561
⑥ SDS-Max spade chisel	400	110	1	1	4932343747	4002395317639
⑦ SDS-Max surface treatment / bushing tool	240	50	1	1	4932352918	4002395375769
⑧ SDS-Max electrode / ground rod driver	220	∅ 13.3	1	1	4932451354	4002395159031
	220	∅ 16.6	1	1	4932451355	4002395159048
	220	∅ 22.2	1	1	4932451356	4002395159055
⑨ SDS-Max tooth removal chisel	215	11	1	1	4932464298	4058546222437
	215	14	1	1	4932464910	4058546228552
⑩ SDS-Max mortar chisel	280	38	1	1	4932472031	4058546324278



PCHDE - Universal chiselling dust extraction system

Universal dust extraction solution fitting to all brands of SDS-Max hammers.

Collects over 90% of chiselled dust.

Saves valuable post cleaning time.

Fits to MILWAUKEE® vacs with easy and secure click system.

Can only be used with DE type chisels listed below.

The following spare parts are available for a quick turnaround: spring (4931328988), rubber rings (5 pc) (4931455278), main housing (4931449576) and front hose with plastic nose (4931455277)



Description	Pack quantity	Min. order quantity	Article Number	EAN Code
PCHDE: Includes 1 x SDS-Max point chisel	1	1	4932455280	4002395247943
PCHDE: Includes 1 x SDS-Max flat chisel	1	1	4932455275	4002395247936
SDS-Max DE point chisel 400 mm long	1	1	4932455144	4002395247981
SDS-Max DE flat chisel 400 mm long	1	1	4932455145	4002395247974

21 mm K-Hex chisels

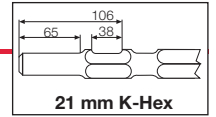

Description	Total length (mm)	Blade width (mm)	Pack quantity	Min. order quantity	Article Number	EAN Code
	380	-	1	1	4932399251	4002395358632
① 21 mm K-Hex pointed chisel	450	-	1	1	4932399252	4002395358649
	600	-	1	1	4932399253	4002395358656
	380	25	1	1	4932399256	4002395358687
② 21 mm K-Hex flat chisel	450	25	1	1	4932399257	4002395358694
	600	25	1	1	4932399258	4002395358700
	300	50	1	1	4932399260	4002395358724
③ 21 mm K-Hex flat wide chisel	300	75	1	1	4932399261	4002395358731
④ 21 mm K-Hex spade chisel	533	110	1	1	4932399264	4002395358762
	222	∅ 12	1	1	4932399265	4002395358779
⑤ 21 mm K-Hex electrode / ground rod driver	222	∅ 25	1	1	4932399269	4002395358816



21 mm K-Hex / SDS-Max special application tools

Tamping tools

Application: Suitable for compacting earth and ballast prior to pouring concrete. Tamping back-fill on ditches. Requires universal taper shank.

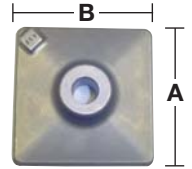

Description	Width (mm) A	Working length (mm) B	Pack quantity	Min. order quantity	Article Number	EAN Code
Tamping plate	120	120	1	1	4932399270	4002395358823

Surface treatment tools

Application: For roughing up concrete before its surface coated i.e. for pitted or uneven floors or walls must often be roughened prior to covering with a new layer of coating. Requires universal taper shank.

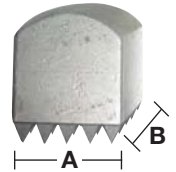

Description	Length (mm) A	Width (mm) B	Pack quantity	Min. order quantity	Article Number	EAN Code
Bushing head (16 teeth)	50	50	1	1	4932399279	4002395358915

Floor cleaning tools

Application: For scraping floor tile adhesive, paint, scree and other floor coatings. Requires universal taper shank.

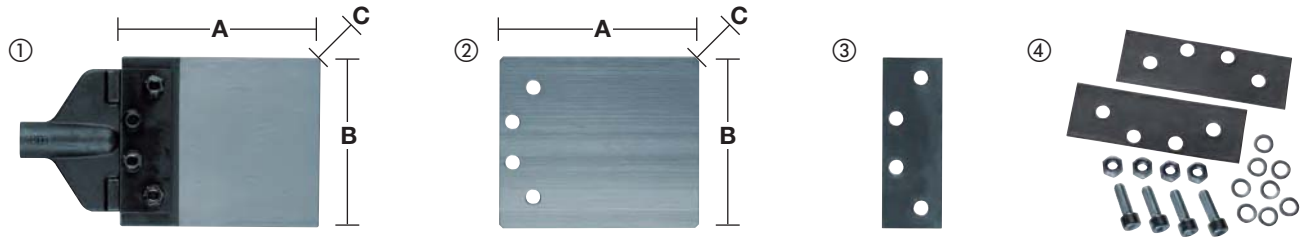

Description	Blade length (mm) A	Blade width (mm) B	Thickness (mm) C	Pack quantity	Min. order quantity	Article Number	EAN Code
① Floor cleaning tool including 2 mm blade. Requires universal taper shank	180	150	2	2	1	4932399272	4002395358847
② Spare 2 mm blade	180	150	2	1	1	4932399273	4002395358854
③ Replacement clamping bracket				1	1	4932399275	4002395358878
④ Floor cleaning service set (18pc) 2 x gasket, 4 x nuts, 4 x screws, 8 x washers				18	1	4932352300	4002395369591

Universal taper shanks



Description	Total length (mm) A	Pack quantity	Min. order quantity	Article Number	EAN Code
① Universal taper shank SDS-Max	300	1	1	4932343771	4002395317745
② Universal taper shank 21 mm K-Hex	450	1	1	4932399280	4002395358922
		1	1	4932399281	4002395358939

Dust guard

Prevents dust and dirt entering the tool reception area when using spades and ground rod drivers.



Description	Pack quantity	Min. order quantity	Article Number	EAN Code
Dust guard cap	1	1	9170086960	4002395565504

28 mm Hex chisels

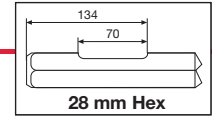

Description	Total length (mm)	Blade width (mm)	Pack quantity	Min. order quantity	Article Number	EAN Code
① 28 mm Hex pointed chisel	400	-	1	1	4932459774	4058546029463
② 28 mm Hex 400 x 35 mm flat chisel	400	35	1	1	4932459775	4058546029470
③ 28 mm Hex flat wide chisel	400	80	1	1	4932459776	4058546029487
④ 28 mm Hex spade chisel	400	125	1	1	4932459777	4058546029494
⑤ 28 mm Hex asphalt cutter	400	90	1	1	4932459778	4058546029500
⑥ 28 mm Hex taper tool holder	-	-	1	1	4932459779	4058546029517
⑦ 28 mm Hex tamping plate	200	200	1	1	4932459780	4058546029524

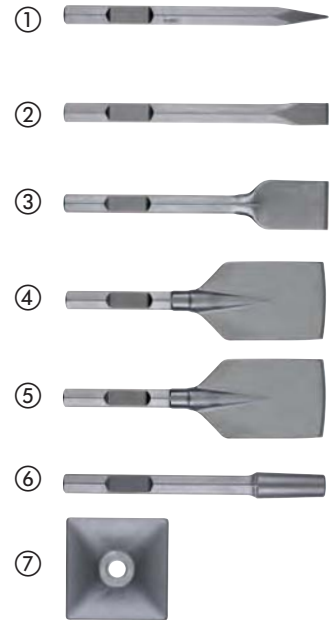

30 mm Hex chisels

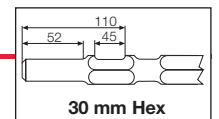

Description	Total length (mm)	Blade width (mm)	Pack quantity	Min. order quantity	Article Number	EAN Code
① 30 mm Hex pointed chisel	400	-	1	1	4932464162	4058546221072
② 30 mm Hex flat chisel	400	32	1	1	4932464163	4058546221089
③ 30 mm Hex flat wide chisel	400	75	1	1	4932464164	4058546221096
④ 30 mm Hex spade chisel	400	100	1	1	4932464165	4058546221102
⑤ 30 mm Hex asphalt cutter	400	90	1	1	4932464166	4058546221119
⑥ 30 mm Hex taper toolholder	-	-	1	1	4932464167	4058546221126

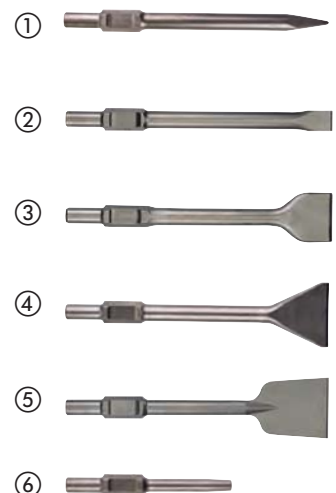

Name		Top view	Suitable for
① SDS-plus	drill		AEG, MILWAUKEE®, Bosch, Dewalt, Hilti, Hitachi, Kango, Makita, Ryobi
① SDS-plus	chisel		AEG, MILWAUKEE®, Bosch, Dewalt, Hilti, Hitachi, Kango, Makita, Ryobi
② SDS-Max	drill		AEG, MILWAUKEE®, Bosch, Dewalt, Hilti, Hitachi, Kango, Makita, Ryobi
② SDS-Max	chisel		AEG, MILWAUKEE®, Bosch, Dewalt, Hilti, Hitachi, Kango, Makita, Ryobi
③ Spline	drill		AEG, MILWAUKEE®, Bosch, Dewalt, Hilti, Hitachi, Kango, Makita, Metabo
④ Twisted spline	chisel		AEG, MILWAUKEE®, Bosch, Dewalt, Hilti, Hitachi, Kango, Makita, Metabo
⑤ 13 mm Hexagon	drill		Hitachi, Makita
⑥ 17 mm Hexagon	chisel		Hitachi, Makita
⑦ 19 mm K-Hexagon	chisel		Kango
⑧ 19 mm Hexagon	chisel		AEG, MILWAUKEE®, Bosch, Dewalt, Ryobi
⑨ 21 mm K-Hexagon	drill		Hitachi, Kango, Makita, MILWAUKEE®
⑩ 21 mm K-Hexagon	chisel		Hitachi, Kango, Makita, MILWAUKEE®
⑪ 28 mm Hexagon	chisel		AEG, MILWAUKEE®
⑫ 30 mm Hexagon	chisel		Atlas Copco, Kango, MILWAUKEE®

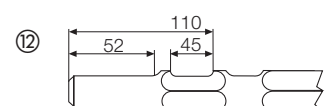
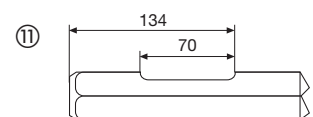
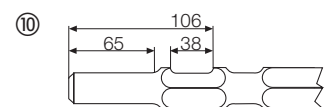
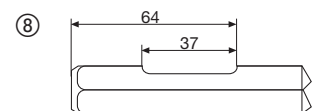
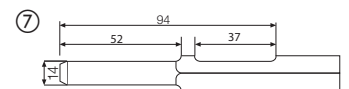
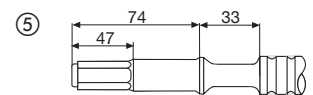
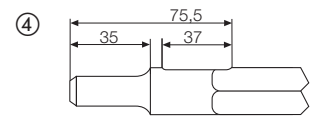
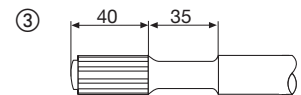
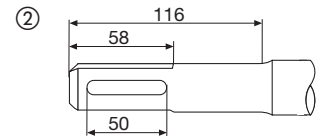
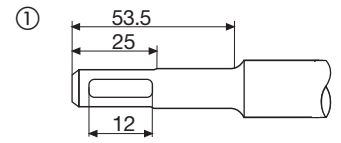

SHOCKWAVE IMPACT DUTY

Multi material drill bits

NEW

Impact rated: Designed for use with impact drivers and all types of 3 jaw chuck tools like rotary drill/ drivers and percussion drills.

Hex shank up to 260mm total length, 3 flat shank on 400mm total length drill bits.

Tungsten carbide tipped (TCT) drill bits allow drilling into concrete, bricks, roof tiles, aerated concrete blocks, thin metal, aluminium, soft to medium hardness ceramic tiles, all wood types and PVC.

White flute to identify the drill bit easily in the users tool box.



Diameter (mm)	Total length (mm)	Working length (mm)	Pack quantity	Min. order quantity	Article Number	EAN Code
3	90	45	1	1	4932471091	4058546287191
4	90	45	1	1	4932471092	4058546287207
5	100	50	1	1	4932471093	4058546287214
5.5	100	50	1	1	4932471094	4058546287221
5.5	150	90	1	1	4932471095	4058546287238
6	100	50	1	1	4932471096	4058546287245
6	150	90	1	1	4932471097	4058546287252
6	200	140	1	1	4932471098	4058546287269
6	400	340	1	1	4932471099	4058546287276
6.5	150	100	1	1	4932471100	4058546287283
6.5	200	140	1	1	4932471101	4058546287290
6.5	400	340	1	1	4932471102	4058546287306
7	100	50	1	1	4932471103	4058546287313
8	120	60	1	1	4932471104	4058546287320
8	260	200	1	1	4932471105	4058546287337
8	400	340	1	1	4932471106	4058546287344
10	120	60	1	1	4932471107	4058546287351
10	260	200	1	1	4932471108	4058546287368
10	400	340	1	1	4932471109	4058546287375
12	150	90	1	1	4932471110	4058546287382
12	260	260	1	1	4932471111	4058546287399
Multi material drill bit set (8pc)						
①	Ø 4 x 90 mm, Ø 5 / 5.5 / 6 / 6 x 100 mm, Ø 8 / 10 x 120 mm, Ø 12 x 150 mm		8	6	4932471112	4058546287405



Multi material drill bit set (8pc)						
	Ø 4 x 90mm, Ø 5 / 5.5 / 5.5 x 100mm, Ø 6 / 7 x 100mm, Ø 8 / 10 x 120mm		8	6	4932471113	4058546287412



Concrete drill bits - round shank - DIN 8039

Diamond ground percussion carbide tip with two cutting edges.
For drilling in brick, tile, ceramic, concrete, plaster, slate and aerated concrete blocks.
Made in Germany.

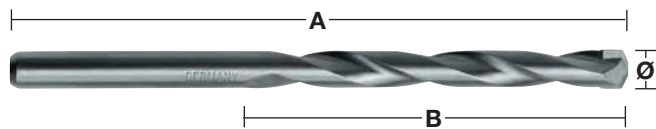

Diameter (mm)	Total length (mm) A	Working length (mm) B	Pack quantity	Min. order quantity	Article Number	EAN Code
3	70	40	1	1	4932363630	4002395332007
3.5	80	45	1	1	4932399916	4002395365746
4	85	50	1	1	4932363631	4002395332014
4.5	85	50	1	1	4932363632	4002395332021
5	85	50	1	1	4932363633	4002395332038
5	150	90	1	1	4932363634	4002395332045
5.5	85	50	1	1	4932363635	4002395332052
5.5	150	90	1	1	4932367035	4002395333998
6	100	60	1	1	4932363636	4002395332069
6	150	90	1	1	4932363637	4002395332076
6	200	150	1	1	4932399383	4002395360000
6	600	550	1	1	4932352506	4002395371648
6.5	100	60	1	1	4932363638	4002395332083
6.5	150	90	1	1	4932367036	4002395334605
7	100	60	1	1	4932363639	4002395332090
7	150	90	1	1	4932367037	4002395334612
7.5	100	60	1	1	4932399917	4002395365753
8	120	80	1	1	4932363640	4002395332106
8	200	150	1	1	4932363641	4002395332113
8	400	350	1	1	4932399384	4002395360017
8	600	550	1	1	4932352507	4002395371655
8.5	120	80	1	1	4932363642	4002395332120
9	120	80	1	1	4932363643	4002395332137
9.5	120	80	1	1	4932399919	4002395365777
10	120	80	1	1	4932363644	4002395332144
10	200	150	1	1	4932363645	4002395332151
10	400	350	1	1	4932399385	4002395360024
10	600	550	1	1	4932352508	4002395371662
11	150	85	1	1	4932363646	4002395332168
12	150	85	1	1	4932363647	4002395332175
12	200	150	1	1	4932363648	4002395332182
12	400	350	1	1	4932399386	4002395360031
12	600	550	1	1	4932352510	4002395371686
13	150	90	1	1	4932363649	4002395332199
13	400	350	1	1	4932352512	4002395371709
14	150	90	1	1	4932363650	4002395332205
14	400	350	1	1	4932399387	4002395360048
14	600	550	1	1	4932352513	4002395371716
15	160	100	1	1	4932399380	4002395359974
16	160	100	1	1	4932373914	4002395353446
16	400	350	1	1	4932399388	4002395360055
16	600	550	1	1	4932352514	4002395371723
18	160	100	1	1	4932399229	4002395358434
18	400	350	1	1	4932352515	4002395371730
20	160	100	1	1	4932399230	4002395358441
20	400	350	1	1	4932399389	4002395360062
20	600	550	1	1	4932352516	4002395371747
①	Concrete drill bits set (5pc) Ø 4 / 5 / 6 / 8 / 10 mm		5	1	4932352333	4002395369928
②	Concrete drill bits set (8pc) Ø 3 / 4 / 5 / 6 / 7 / 8 / 9 / 10 mm		8	1	4932352334	4002395369935

①



②



Premium concrete drill bits - 3 flat shank

NEW

Tungsten carbide tipped (TCT) drill bits allow drilling into concrete, aerated concrete blocks, masonry, slate and granite.

From Ø 5 mm the hammer drill bits are supplied with a 3 flat shank to prevent the drill bit slipping in the chuck.

Ø 3 & 4 mm the drill bits are supplied with a round shank.

Red flute to identify the drill bit easily in the users tool box.

Can be used in hammer and rotary mode.

Diameter (mm)	Total length (mm)	Working length (mm)	Pack quantity	Min. order quantity	Article Number	EAN Code
3	90	45	1	1	4932471167	4058546287955
4	90	45	1	1	4932471169	4058546287979
5	100	50	1	1	4932471171	4058546287993
5.5	100	50	1	1	4932471173	4058546288013
6	100	50	1	1	4932471175	4058546288037
6	150	90	1	1	4932471176	4058546288044
6.5	100	50	1	1	4932471178	4058546288068
6.5	150	90	1	1	4932471179	4058546288075
7	100	50	1	1	4932471180	4058546288082
7	150	90	1	1	4932471181	4058546288099
8	100	50	1	1	4932471182	4058546288105
8	150	90	1	1	4932471183	4058546288112
10	150	90	1	1	4932471186	4058546288143
10	260	200	1	1	4932471187	4058546288150
12	150	90	1	1	4932471188	4058546288167
12	260	200	1	1	4932471189	4058546288174
14	150	90	1	1	4932471190	4058546288181
14	260	200	1	1	4932471191	4058546288198
Premium concrete drill bit set (8pc)						
①	Ø 4 x 90 mm, Ø 5 / 5.5 / 5.5 / 6 / 7 x 100 mm, Ø 8 / 10 x 150 mm		8	6	4932471193	4058546288211
Premium concrete drill bit set (8pc)						
	Ø 4 x 90 mm, Ø 5 / 5 / 6 / 6 x 100 mm, Ø 8 / 10 / 12 x 150 mm		8	6	4932471192	4058546288204



Glass & tile bits

NEW

Suitable for drilling in non toughened glass, soft to medium hardness tiles and ceramics.

Sharpened carbide for faster drilling.

Reinforced carbide head for increased durability.

Red painted tip.

From Ø 5 mm the glass & tile drill bits are supplied with a multi-flat shank to prevent the drill bit slipping in the chuck.

Diameter (mm)	Total length (mm)	Pack quantity	Min. order quantity	Article Number	EAN Code
3	50	1	1	4932471955	4058546298548
4	50	1	1	4932471956	4058546298555
5	50	1	1	4932471957	4058546298562
5.5	50	1	1	4932471855	4058546297541
6	60	1	1	4932471958	4058546298579
6.5	60	1	1	4932471856	4058546297558
7	60	1	1	4932471857	4058546297565
8	60	1	1	4932471959	4058546298586
10	95	1	1	4932471960	4058546298593
12	95	1	1	4932471961	4058546298609
14	95	1	1	4932471858	4058546297572
16	100	1	1	4932471859	4058546297589



Impact rated wood auger bits

Suitable for use with all types of corded / cordless drills including impact wrenches. Drilling with an impact wrench enables drilling holes with less effort, one hand drilling, drilling up a ladder and above head height with less risk of injury from the tool clutching out.

Special zone hardening process ensures an extra hard shank, durable tip and perfectly flexible bit body.

New MILWAUKEE® Through-Center head geometry with the lead cutting edge lines up with the center of the feed screw - this ensures efficient chip removal and allows for continuous feeding.

20° rake angle of the lead cutting edge creates a path for easy chip ejection.

Polished and powder coated flute design produces a non-stick surface for increased chip ejection, reduced chip clogging and higher selffeeding capability.

Milling marks are removed in the finishing process, creating a smooth surface.

Lewis flute with large, wide throat design for rapid chip removal.

Sharp ground cutting lips for smooth clean holes.

Resharpenable cutting lips.

With 7/16" shank - to fit square drive 1/2" impact wrenches the adaptor 48660061 is required.

Suitable for hard & soft wood, wet & treated wood, plywood, chipboard, WPC (wood plastic composite), laminated beams and panels, exotic and hard woods e.g. bongossi, iroko, teak, beech, oak, etc.



Impact wood auger bits - short series

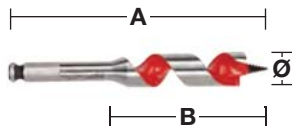

Special short design enables drilling in tight and normally non accessible places.

Diameter (mm)	Total length (mm) A	Working length (mm) B	Shank reception	Pack quantity	Min. order quantity	Article Number	EAN Code
18	153	100	7/16" Hex	1	1	48130683	045242091379
20	153	100	7/16" Hex	1	1	48130813	045242091522
22	153	100	7/16" Hex	1	1	48130873	045242091638
25	153	100	7/16" Hex	1	1	48131003	045242091782
28	153	100	7/16" Hex	1	1	48131123	045242091935
32	153	100	7/16" Hex	1	1	48131253	045242092031

Impact wood auger bits - long series

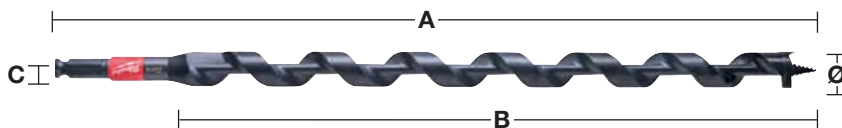

Diameter (mm)	Total length (mm) A	Working length (mm) B	Shank reception	Pack quantity	Min. order quantity	Article Number	EAN Code
14	460	395	7/16" Hex	1	1	48136754	045242518999
16	460	395	7/16" Hex	1	1	48136756	045242519002
18	460	395	7/16" Hex	1	1	48136758	045242500994
19	460	395	7/16" Hex	1	1	48136759	045242519019
20	460	395	7/16" Hex	1	1	48136760	045242501007
22	460	395	7/16" Hex	1	1	48136762	045242519033
26	460	395	7/16" Hex	1	1	48136766	045242501014
29	460	395	7/16" Hex	1	1	48136769	045242519057
Impact wood auger bit set (4pc) available in a pouch Ø 14 / 16 / 18 / 20 x 460 mm				4	1	48136780	045242005383

Impact wood auger and selffeed bits - adaptor

Description	Pack quantity	Min. order quantity	Article Number	EAN Code
Socket adaptor: 1/2" square to 7/16" and 11 mm Hex. For 7/16" selffeed bits and impact auger bits	1	1	48660061	045242155118



Wood drilling speeds

The following tables give recommended drilling speeds for the most efficient cutting speed. The tables should only be used as a guide and are dependant on the user and material being drilled.

Auger bits

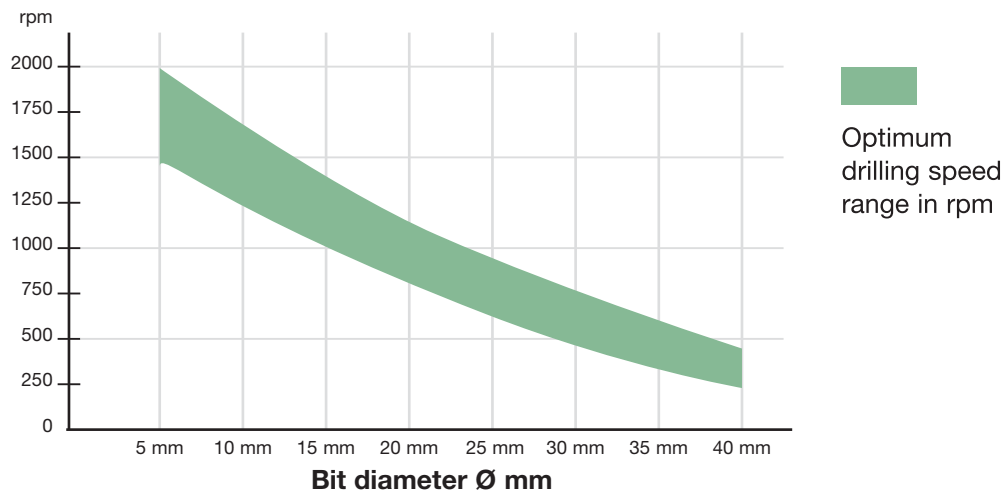

Forstner bits / Selffeed bits

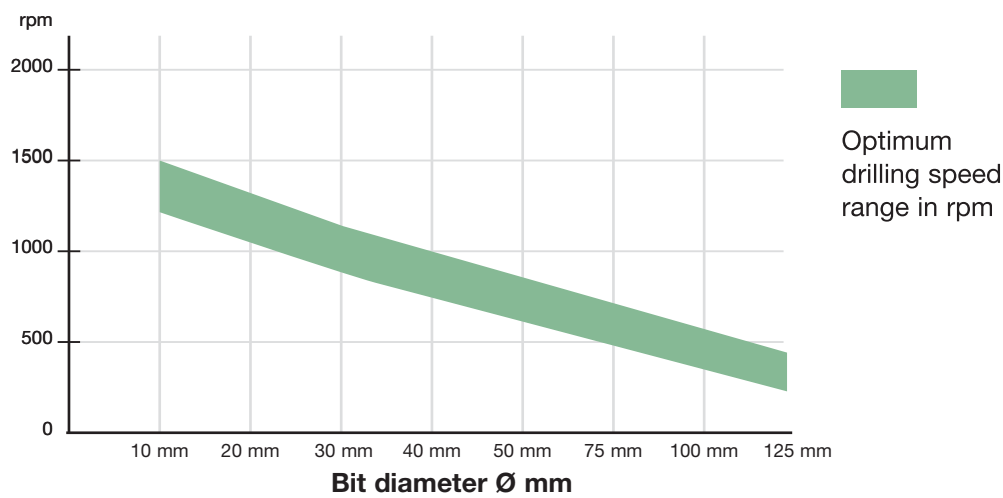

Wood auger bits

For heavy duty, precision drilling in soft and hard wood, large section beams, joists, floor boarding, chipboard and plywood.
Lewis flute design for rapid chip removal.
With Hex shank for secure chuck grip.

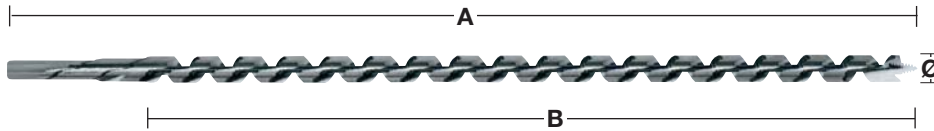

Diameter (mm)	Total length (mm) A	Working length (mm) B	Shank reception	Pack quantity	Min. order quantity	Article Number	EAN Code
6	230	155	6.5 mm Hex	1	1	4932430175	4002395378364
6	460	385	6.5 mm Hex	1	1	4932430176	4002395378371
8	230	155	6.5 mm Hex	1	1	4932363681	4002395331796
8	460	385	6.5 mm Hex	1	1	4932363688	4002395331710
10	230	155	8.5 mm Hex	1	1	4932363682	4002395331802
10	460	385	8.5 mm Hex	1	1	4932363689	4002395331727
10	600	530	8.5 mm Hex	1	1	4932363696	4002395331642
12	230	155	10 mm Hex	1	1	4932363683	4002395331819
12	460	385	10 mm Hex	1	1	4932363690	4002395331734
12	600	530	10 mm Hex	1	1	4932363697	4002395331659
14	230	155	11 mm Hex	1	1	4932363684	4002395331826
14	460	385	11 mm Hex	1	1	4932363691	4002395331741
14	600	530	11 mm Hex	1	1	4932363698	4002395331666
16	230	155	11 mm Hex	1	1	4932363685	4002395331833
16	460	385	11 mm Hex	1	1	4932363692	4002395331758
16	600	530	11 mm Hex	1	1	4932363699	4002395331673
18	230	155	11 mm Hex	1	1	4932363686	4002395331840
18	460	385	11 mm Hex	1	1	4932363693	4002395331765
18	600	530	11 mm Hex	1	1	4932363700	4002395331680
20	230	155	11 mm Hex	1	1	4932363687	4002395331857
20	460	385	11 mm Hex	1	1	4932363694	4002395331772
20	600	530	11 mm Hex	1	1	4932363701	4002395331697
22	230	155	11 mm Hex	1	1	4932373363	4002395347889
22	460	385	11 mm Hex	1	1	4932363695	4002395331789
22	600	530	11 mm Hex	1	1	4932363702	4002395331703
24	230	155	11 mm Hex	1	1	4932373364	4002395347896
24	460	385	11 mm Hex	1	1	4932373370	4002395348558
26	230	155	11 mm Hex	1	1	4932373365	4002395348503
26	460	385	11 mm Hex	1	1	4932373371	4002395348565
28	230	155	11 mm Hex	1	1	4932373366	4002395348510
28	460	385	11 mm Hex	1	1	4932373372	4002395348572
30	230	155	11 mm Hex	1	1	4932373367	4002395348527
30	460	385	11 mm Hex	1	1	4932373373	4002395348589
32	230	155	11 mm Hex	1	1	4932373368	4002395348534
32	460	385	11 mm Hex	1	1	4932373374	4002395348596
Wood auger bits set (6pc)			Wood case	6	1	4932373380	4002395349258
① Ø 8 / 10 / 12 / 14 / 16 / 18 mm x 230 mm							

Forstner bits

Centre point for precisely locating the bit. Peripheral cutters ensure splinter free drilling in all natural soft and hard woods. Manufactured according to DIN 74836. Suitable for heavy-duty applications in all natural, soft and hard woods.

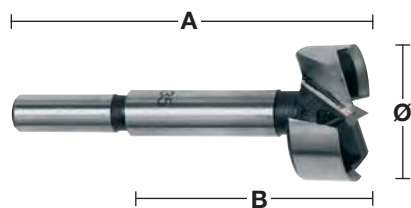

Diameter (mm)	Total length (mm) A	Working length (mm) B	Shank reception	Pack quantity	Min. order quantity	Article Number	EAN Code
10	90	50	9.5 mm round shank	1	1	4932363703	4002395331468
12	90	50	9.5 mm round shank	1	1	4932363704	4002395331475
14	90	50	9.5 mm round shank	1	1	4932363705	4002395331482
15	90	50	9.5 mm round shank	1	1	4932363883	4002395333738
16	90	50	9.5 mm round shank	1	1	4932363706	4002395331499
18	90	50	9.5 mm round shank	1	1	4932363707	4002395331505
20	90	50	9.5 mm round shank	1	1	4932363708	4002395331512
25	90	50	9.5 mm round shank	1	1	4932363711	4002395331543
26	90	50	9.5 mm round shank	1	1	4932363712	4002395331550
30	90	50	9.5 mm round shank	1	1	4932363714	4002395331574
32	90	50	9.5 mm round shank	1	1	4932363715	4002395331581
35	90	50	9.5 mm round shank	1	1	4932363717	4002395331604
40	90	50	9.5 mm round shank	1	1	4932363720	4002395331635
50	90	50	9.5 mm round shank	1	1	4932373923	4002395353538
Forstner drill bits set (5pc)							
① Ø 15 / 20 / 25 / 30 / 35 mm				5	1	4932373379	4002395349241

SWITCHBLADE™ selffeed bits

Speed: Aggressive feed screw design allows the bit to pull through the wood faster and without effort, resulting in faster drilling.

Replaceable SWITCHBLADE™: The SWITCHBLADE™ replaceable blade system ensures your blade is always razor sharp. It increases productivity by eliminating resharpening downtime and it increases the overall life of the bit.

Application: Suitable for all general contractors, electricians, plumbers and HVAC engineers who require to drill through holes in wood for all types of pipe, vents and wire trunking.

Each selffeed bit is supplied with 1x blade, 2x replaceable feed screws, 1x set screws and 1x allen key.



Diameter (mm)	Shank reception	Pack quantity	Min. order quantity	Article Number	EAN Code
35	7/16" Hex	1	1	48255120	045242157471
38	7/16" Hex	1	1	48255125	045242157488
51	7/16" Hex	1	1	48255135	045242157495
54	7/16" Hex	1	1	48255140	045242157525
57	7/16" Hex	1	1	48255143	045242225903
65	7/16" Hex	1	1	48255150	045242157532

SWITCHBLADE™ set

Description	Pack quantity	Min. order quantity	Article Number	EAN Code
SWITCHBLADE™ selffeed bits set (5pc) 4 x SWITCHBLADE™ selffeed bits: Ø 35 / 38 / 54 / 65 mm, QUIK-LOK extension 140 mm length, 4 x Replacement SWITCHBLADE™ blades (1 for each size bit), 4 x feed screws, 4 x set screws, 1 x allen key	5	1	49225100	045242157686



SWITCHBLADE™ replacement blades

Diameter (mm)	Pack quantity	Min. order quantity	Article Number	EAN Code
35	1	1	48255420	045242225842
38	1	1	48255425	045242225859
51	1	1	48255435	045242225866
54	1	1	48255440	045242225873
57	1	1	48255443	045242225880
65	1	1	48255450	045242226474



SWITCHBLADE™ service kit in storage container 1x feed screw, 2x set screws, 1x allen key, 1x storage container also can store spare SWITCHBLADE™	5	1	48255280	045242225934
--	---	---	----------	--------------

SHOCKWAVE IMPACT DUTY TM

Selffeed bits

All sizes have removable and replaceable feed screws.
 Two feed screws supplied with each bit.
 Feed screw provides fast, effortless feeding even in gummy woods.
 Internal cutting plane shaves hole radius for clean, smooth holes without pressure.
 Each selffeed bit is supplied with 2 x feed screws, 1 x set screw and 1 x allen key.

Diameter (mm)	Shank reception	Pack quantity	Min. order quantity	Article Number	EAN Code
25	7/16" Hex	1	1	48251002	045242119028
29	7/16" Hex	1	1	48251122	045242119073
32	7/16" Hex	1	1	48251252	045242119127
35	7/16" Hex	1	1	48251372	045242119172
38	7/16" Hex	1	1	48251502	045242119226
44	7/16" Hex	1	1	48251752	045242119271
51	7/16" Hex	1	1	48252002	045242119325
54	7/16" Hex	1	1	48252122	045242119370
57	7/16" Hex	1	1	48252252	045242119424
65	7/16" Hex	1	1	48252562	045242119479
Feed screw coarse thread 1/4"		1	1	48286870	045242122707
Allen key 1/8" for all arbors		1	1	49960060	045242221455
Set screw for drills up to 65 mm		1	1	06832625	-



Large selffeed bits

Large selffeed bits in 76, 92 and 116 mm sizes have double internal cutter blades that shave hole radius for clean, smooth holes without pressure.
 Replaceable arbor.

Diameter (mm)	Shank reception	Pack quantity	Min. order quantity	Article Number	EAN Code
76	7/16" Hex	1	1	48253001	045242119509
92	7/16" Hex	1	1	48253621	045242119554
116	7/16" Hex	1	1	48254621	045242119608
Replaceable arbor		1	1	48070201	045242088904
Feed screw regular thread		1	1	48286880	045242122806
Set screw for drills up over 76mm		1	1	06833150	4058546040864
Allen key 5/32"		1	1	49960070	045242221554



Selffeed bits contractors kit

Description	Pack quantity	Min. order quantity	Article Number	EAN Code
Contractors kit (7pc)				
Selffeed bits Ø 25 / 29 / 32 / 38 / 44 / 54 / 65 mm, extension 140 mm length and feed screws	7	1	49220130	045242180301



Shank extensions

For selffeed bits, auger bits and holesaws (25 mm / 1" diameter and larger) with 7/16" Hex shank

Total length (mm) A	Pack quantity	Min. order quantity	Article Number	EAN Code
① 140	1	1	48281030	045242122653
300	1	1	48284006	045242122516
② 450	1	1	48284011	045242122561
600	1	1	48284016	045242122615

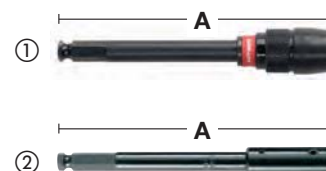

Lip & spur / brad point bits for wood - DIN 7487 E

Suitable for drilling hardboard, plywood, chipboard and all natural hard and soft wood.
Produced according to DIN 7487 E.

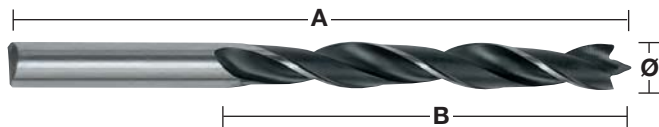

Diameter (mm)	Total length (mm) A	Working length (mm) B	Shank reception	Pack quantity	Min. order quantity	Article Number	EAN Code
3	60	33	3 mm round shank	1	1	4932363651	4002395331307
4	75	43	4 mm round shank	1	1	4932363652	4002395331314
5	86	52	5 mm round shank	1	1	4932363653	4002395331321
6	97	60	6 mm round shank	1	1	4932363654	4002395331338
7	109	69	7 mm round shank	1	1	4932363655	4002395331345
8	117	75	8 mm round shank	1	1	4932363656	4002395331352
9	125	80	9 mm round shank	1	1	4932363657	4002395331369
10	133	87	10 mm round shank	1	1	4932363658	4002395331376
11	142	89	10 mm round shank	1	1	4932363659	4002395331383
12	151	96	10 mm round shank	1	1	4932363660	4002395331390
13	151	96	10 mm round shank	1	1	4932363661	4002395331406
14	151	97	10 mm round shank	1	1	4932363662	4002395331413
15	151	97	10 mm round shank	1	1	4932363663	4002395331420
16	151	97	10 mm round shank	1	1	4932363664	4002395331437
18	180	120	10 mm round shank	1	1	4932363665	4002395331444
20	200	130	10 mm round shank	1	1	4932363666	4002395331451
① Wood drill bit set (5pc) Ø 4 / 5 / 6 / 8 / 10 mm			Plastic cassette	5	1	4932352465	4002395371242
② Wood drill bit set (8pc) Ø 3 / 4 / 5 / 6 / 7 / 8 / 9 / 10 mm			Plastic cassette	8	1	4932352466	4002395371259

Flat boring bits

Fast drilling of big diameters.

Suitable for drilling in natural hard and softwood and chipboard.

Ideal for door locks, morticing, electrical and plumbing work.

1/4" Hex shank reception (DIN E 6.3) for direct insertion into the power tool or for secure chuck grip.

Ground centre point for accurate positioning and sharp wings (not applicable to 6 & 8 mm) for improved cutting performance.

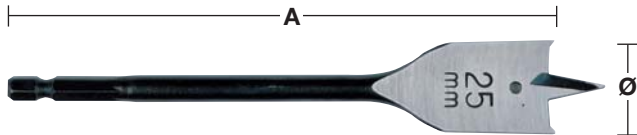

①

Diameter (mm)	Total length (mm) A	Pack quantity	Min. order quantity	Article Number	EAN Code
6	152	1	1	4932352487	4002395371457
6	400	1	1	4932352488	4002395371464
8	152	1	1	4932363130	4002395332618
8	400	1	1	4932352489	4002395371471
10	152	1	1	4932363131	4002395332625
10	400	1	1	4932352490	4002395371488
12	152	1	1	4932363132	4002395332632
12	400	1	1	4932352491	4002395371495
13	152	1	1	4932363133	4002395332649
13	400	1	1	4932352492	4002395371501
14	152	1	1	4932363134	4002395332656
14	400	1	1	4932352493	4002395371518
16	152	1	1	4932363135	4002395332663
16	400	1	1	4932352494	4002395371525
18	152	1	1	4932363136	4002395332670
18	400	1	1	4932352495	4002395371532
19	152	1	1	4932363137	4002395332687
19	400	1	1	4932352496	4002395371549
20	152	1	1	4932363138	4002395332694
20	400	1	1	4932352497	4002395371556
22	152	1	1	4932363139	4002395332700
22	400	1	1	4932352498	4002395371563
24	152	1	1	4932363140	4002395332717
25	152	1	1	4932363141	4002395332724
25	400	1	1	4932352499	4002395371570
26	152	1	1	4932363142	4002395332731
28	152	1	1	4932363143	4002395332748
28	400	1	1	4932352500	4002395371587
30	152	1	1	4932363144	4002395332755
30	400	1	1	4932352501	4002395371594
32	152	1	1	4932363145	4002395332762
32	400	1	1	4932352502	4002395371600
35	400	1	1	4932352503	4002395371617
36	152	1	1	4932363146	4002395332779
38	152	1	1	4932363147	4002395332786
① Flat bit set (8pc) Ø 12 / 16 / 18 / 20 / 22 / 25 / 28 / 32 x 152 mm length		8	1	4932352504	4002395371624

Extension



Description	Total length (mm) A	Shank reception	Tool reception	Pack quantity	Min. order quantity	Article Number	EAN Code
Extension	305	1/4" Hex	1/4" Hex	1	1	4932363148	4002395332793

SPEED FEED[™] wood drill bits

Step up from flat bit in quality and performance - faster drilling, higher lifetime and less jamming!
 Dual cutting edges for fast and aggressive cut - up to 10 times faster drilling vs. flat boring bit.
 Tapered design for reduced chip clogging, less friction and less jamming even in tough applications - results in less breakages.
 Feed screw with coarse thread increases selffeeding in all types of wood - soft & hard, wet & treated.
 Polished and powder coated flute design for increased chip ejection, reduced clogging and higher selffeeding capability.

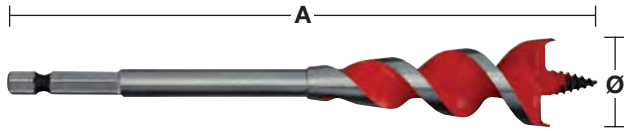

Dual cutting edges

Diameter (mm)	Ø (inch)	Total length (mm) A	Shank reception	Pack quantity	Min. order quantity	Article Number	EAN Code
13	1/2"	165	1/4" Hex	1	1	48130048	045242224807
16	5/8"	165	1/4" Hex	1	1	48130058	045242224814
18	3/4"	165	1/4" Hex	1	1	4932464071	4058546220167
20	3/4"	165	1/4" Hex	1	1	48130068	045242224821
22	7/8"	165	1/4" Hex	1	1	48130078	045242224838
25	1"	165	1/4" Hex	1	1	48130088	045242224845
32	1 1/4"	165	1/4" Hex	1	1	48130108	045242224852
SPEED FEED[™] set (4pc) Ø 13 / 16 / 20 / 25 mm				4	1	48130400	045242234448



Tapered design





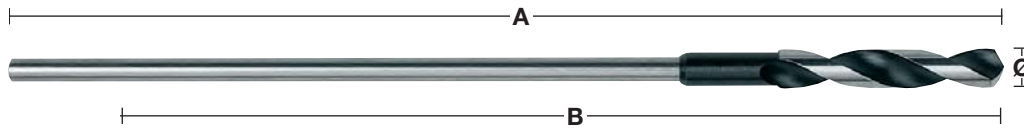



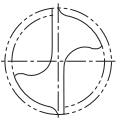
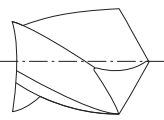

HSS cable bits - DIN 7490

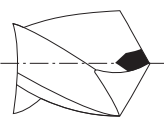
Manufactured from HSS steel for increased lifetime. Suitable for drilling through holes in wood, plasterboard and metal channel.
 Manufactured according to DIN 7490 and conforming to the German Employer's Liability Insurance Association in terms of safety requirements for the building trade. The body of the drill bit is attached to the cylindrical shank by means of a thread, therefore eliminating the risk of breakage and guaranteeing absolute concentricity. The small twist angle and enlarged flutes ensure rapid and clog-free chip removal.
 Made in Germany.

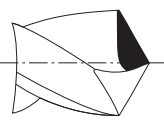

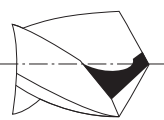
Diameter (mm)	Total length (mm) A	Working length (mm) B	Shank reception	Pack quantity	Min. order quantity	Article Number	EAN Code
6	400	300	5 mm round shank	1	1	4932399672	4002395363223
6	600	500	5 mm round shank	1	1	4932399675	4002395363254
8	400	300	6 mm round shank	1	1	4932363667	4002395331932
8	600	500	6 mm round shank	1	1	4932363674	4002395331864
10	400	300	8 mm round shank	1	1	4932363668	4002395331949
10	600	500	8 mm round shank	1	1	4932363675	4002395331871
12	400	300	8 mm round shank	1	1	4932363669	4002395331956
12	600	500	8 mm round shank	1	1	4932363676	4002395331888
14	400	300	8 mm round shank	1	1	4932363670	4002395331963
14	600	500	8 mm round shank	1	1	4932363677	4002395331895
16	400	300	10 mm round shank	1	1	4932363671	4002395331970
16	600	500	10 mm round shank	1	1	4932363678	4002395331901
18	400	300	10 mm round shank	1	1	4932363672	4002395331987
18	600	500	10 mm round shank	1	1	4932363679	4002395331918
20	400	300	10 mm round shank	1	1	4932363673	4002395331994
20	600	500	10 mm round shank	1	1	4932363680	4002395331925
22	400	300	10 mm round shank	1	1	4932399673	4002395363230
22	600	500	10 mm round shank	1	1	4932399676	4002395363261

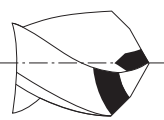
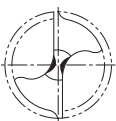
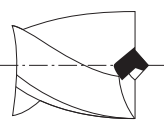
HSS Drill bit tip geometry

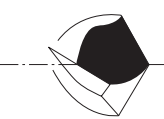
		Standard/Form	Application	Features
		Normal Standard Point	For standard drilling in ferrous/non ferrous metals and plastics	The wide cutting edge provides a drill bit that is robust and resistant to sideways pressure. Due to the wide cutting edge higher feed pressure is required. Can be easily resharpened.
		Chisel Edge Point DIN 1412 A	For drilling work in solid steel with large diameter drill bits.	Good and easy centering. Requires very low feed pressure – approx. 30% less than a normal point drill bit.
		Chisel Edge Point with corrected cutting edge DIN 1412 B	For drilling in high strength steel and high alloy steels. Also suitable for drilling thin sheet material.	Robust and resistant to sideways pressure.
		Split Point DIN 1412 C	For drilling in high strength steel and high alloy steels. Suitable for deep drilling bits.	Excellent chip removal makes this design ideal for deep drilling applications. Good centering. Low feed pressure required.
		Double Angle Point for Cast Iron DIN 1412 D	For drilling cast iron.	Extended major cutting edges reduce wear on the cutting corners for improved lifetime. Good heat conduction. Resistant to sideways pressure.
		Centre Point DIN 1412 E	For drilling thin sheet metal and soft materials.	Easy centering. Low feed pressure required. Does not snatch when drilling thin materials. Accurate and clean holes.
		U Point	For high performance drilling in high strength steels such as stainless and acid resistant steel.	Easy centering. Produces small metal chips ensuring low heat build up and quicker material resulting in faster drilling.

HSS Drill bit application guide

The following table gives recommended drilling speeds for the most efficient cutting speed. The tables should only be used as a guide and are dependant on the user and material being drilled. Coolants and lubricants will improve tool life by up to 5 times and workpiece finish.

Material class		Material type	Hardness/ Tensile Strength N/mm ²	Rockwell	Hole diameter Ø mm – RPM					Cooling agent
					Ø 1-2	Ø 3-5	Ø 6-10	Ø 11-15	Ø 16-20	
Steel	Speed	Non-alloyed construction steel, non-alloyed case hardened steel	< 400	< HRB 69	4770	1870	930	630	470	Drilling emulsion, cutting oil
			400-800	< HRC 21	4450	1770	870	580	430	
		Sheet Steel	< 800	< HRC 21	4450	1760	860	560	430	Drilling emulsion, ester oil
		Non-alloyed tool steel	< 800	< HRC 21	4440	1760	860	560	430	Drilling emulsion, cutting oil
		Alloyed tool steel	< 800	< HRC 21	3950	1550	780	520	390	Drilling emulsion, ester oil
			> 800	> HRC 21	1950	800	390	275	200	
	Alloyed hardened & tempered steel	< 1200	< HRC 37	2100	890	450	300	210	Drilling emulsion, ester oil	
> 1200		> HRC 38	1350	540	260	170	120			
Feed	Feed (mm/rev)				0.03	0.09	0.15	0.20	0.25	
Stainless steel	Speed	Stainless steel	< 1000	< HRC 30	2250	930	450	290	220	Rapeseed oil, cutting oil
		Stainless steel	1000-1200	HRC 30-37	1430	560	280	190	130	
	Feed	Feed (mm/rev)				0.02	0.06	0.13	0.18	0.24
Cast iron	Speed	Malleable cast iron	750	HRB 99	4700	2000	1100	800	600	Dry
		Soft	450	HRB 75	4500	1700	950	650	550	Drilling emulsion, cutting oil
		Hard	700	HRB 96	3450	1350	680	440	340	
	Feed	Feed (mm/rev)				0.05	0.10	0.16	0.20	0.25
Aluminium	Speed		< 350	< HRC 59	8700	3560	1720	1130	860	Drilling emulsion, cutting oil
	Feed	Feed (mm/rev)				0.02	0.08	0.13	0.18	0.23
Copper	Speed				5100	2000	990	670	500	Drilling emulsion, cutting oil
	Feed	Feed (mm/rev)				0.02	0.10	0.20	0.28	0.35
Bronze	Speed				7950	3190	1480	1010	770	Dry
	Feed	Feed (mm/rev)				0.02	0.11	0.21	0.32	0.35
Brass	Speed				7950	3190	1480	1010	770	Drilling emulsion
	Feed	Feed (mm/rev)				0.02	0.11	0.21	0.32	0.35
Magnesium	Speed				9550	3800	1900	1250	970	Dry
	Feed	Feed (mm/rev)				0.05	0.10	0.25	0.30	0.35
Plastics	Speed	PVC, Polyamide, Thermoplastics			3500	2500	1800	700	450	Water
	Feed	Feed (mm/rev)				0.05	0.10	0.16	0.21	0.23

RPM: The number of revolutions that a spindle/a cutting tool completes in one minute.

Feed: This is the linear distance at which the cutter is advanced against the workpiece during one rotation of the cutting tool. It is expressed in units of distance per revolution – millimetres per revolution.

HSS Drill bit application guide

Material class	Material type	Hardness/ Tensile Strength N/mm ²	Rockwell	HSS-R DIN 338	HSS-G Thunderweb DIN 340 DIN 1897 Double Ended	RED COBALT - HSS-Ground - DIN 338	RED HEX - Shockwave HSS- Ground Titanium	Step drills	Shockwave Step drills	Cooling agent	
Steel	Non-alloyed construction steel, non-alloyed case hardened steel	< 400	< HRB 69		●	●	●	●	●	Drilling emulsion, cutting oil	
		400-800	< HRC 21	●	●	●	●	●	●		
	Sheet Steel	< 800	< HRC 21		●	●	●	●	●	Drilling emulsion, ester oil	
	Non-alloyed tool steel	< 800	< HRC 21	●	●	●	●	●	●	Drilling emulsion, cutting oil	
	Alloyed tool steel	< 800	< HRC 21		●	●	●	●	●	●	Drilling emulsion, ester oil
		> 800	> HRC 21		●	●	●	▲	▲		
Alloyed hardened & tempered steel	< 1200	< HRC 37				●	●	▲	▲	Drilling emulsion, ester oil	
	> 1200	> HRC 38				●	●	▲			
Stainless steel	Stainless steel	< 1000	< HRC 30		▲	●	●	▲		Rapeseed oil, cutting oil	
	Stainless steel	1000-1200	HRC 30-37			●	●	▲			
Cast iron	Malleable cast iron	750	HRB 99	●	●	●	●	●	●	Dry	
	Soft	450	HRB 75	●	●	●	●	▲		Drilling emulsion, cutting oil	
	Hard	700	HRB 96	●	●	●	●	●	●		
Aluminium		< 350	< HRC 59		▲	●	●	●	●	Drilling emulsion, cutting oil	
Copper					▲	●	●	●	●	Drilling emulsion, cutting oil	
Bronze				●	●	●	●	●	●	Dry	
Brass				●	●	●	●	●	●	Drilling emulsion	
Magnesium						●	●			Dry	
Plastics	PVC, Polyamide, Thermoplastics				●	●	●	●	●	Water	
Wood				●	●	●	●			Dry	

● Most suitable. Recommended for these materials. ▲ Suitable. Recommended for intermittent use in these materials.

Metal drill bits HSS rollforged - DIN 338 - 5 and 10 pack

High speed steel rollforged metal drill bits produced according to DIN 338. Oxide coating enables quick swarf removal. Normal point shaped cutting tip with 118° angle. Type N flute normal angle. Suitable for drilling in steel, cast iron, alloyed and non-alloyed material up to 800 N/mm². Colour: black.

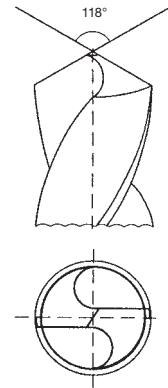

Diameter (mm)	Total length (mm) A	Working length (mm) B	Pack quantity	Min. order quantity	Article Number	EAN Code
1.0	34	12	10	1	4932363444	4002395329458
1.5	40	18	10	1	4932363449	4002395329502
2.0	49	24	10	1	4932363454	4002395329557
2.5	57	30	10	1	4932363459	4002395329601
3.0	61	33	10	1	4932363464	4002395329656
3.2	65	36	10	1	4932363466	4002395329670
3.5	70	39	10	1	4932363469	4002395329700
4.0	75	43	10	1	4932363474	4002395329755
4.2	75	43	10	1	4932363476	4002395329779
4.5	80	47	10	1	4932363479	4002395329809
4.8	86	52	10	1	4932363482	4002395329830
5.0	86	52	10	1	4932363484	4002395329854
5.5	93	57	10	1	4932363489	4002395329908
6.0	93	57	10	1	4932363494	4002395329953
6.5	101	63	10	1	4932363499	4002395330003
6.8	109	69	10	1	4932363502	4002395330034
7.0	109	69	10	1	4932363504	4002395330058
7.5	109	69	10	1	4932363509	4002395330102
8.0	117	75	10	1	4932363514	4002395330157
8.5	117	75	10	1	4932363519	4002395330201
9.0	125	81	10	1	4932363524	4002395330256
9.5	125	81	10	1	4932363529	4002395330300
10.0	133	87	10	1	4932363534	4002395330355
10.5	133	87	5	1	4932363539	4002395330409
11.0	142	94	5	1	4932363544	4002395330454
11.5	142	94	5	1	4932363549	4002395330508
12.0	151	101	5	1	4932363554	4002395330553
12.5	151	101	5	1	4932363559	4002395330607
13.0	151	101	5	1	4932363564	4002395330652

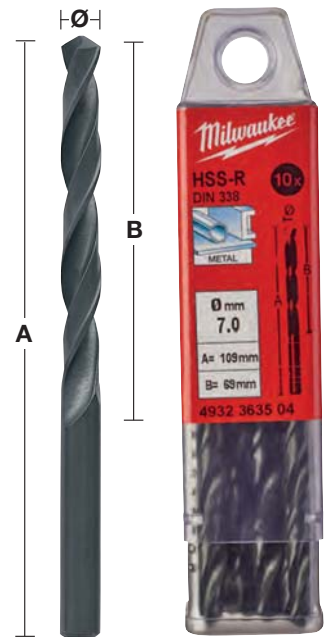

Metal drill bits HSS rollforged - DIN 338 - cassettes

Description	Supplied in	Pack quantity	Min. order quantity	Article Number	EAN Code
HSS-R drill bits set (19pc)					
① Ø 1 / 1.5 / 2 / 2.5 / 3 / 3.5 / 4 / 4.5 / 5 / 5.5 / 6 / 6.5 / 7 / 7.5 / 8 / 8.5 / 9 / 9.5 / 10 mm	Metal case	19	1	4932352468	4002395371273
HSS-R drill bits set (25pc)					
② Ø 1 / 1.5 / 2 / 2.5 / 3 / 3.5 / 4 / 4.5 / 5 / 5.5 / 6 / 6.5 / 7 / 7.5 / 8 / 8.5 / 9 / 9.5 / 10 / 10.5 / 11 / 11.5 / 12 / 12.5 / 13 mm	Metal case	25	1	4932352469	4002395371280



Metal drill bits HSS Rollforged - DIN 338 with reduced shank

High speed steel rollforged metal drill bits produced according to DIN 338.
 Oxide coating enables quick swarf removal.
 Normal point shaped cutting tip with 118° angle.
 Type N flute normal angle.
 Suitable for drilling in steel, cast iron, alloyed and non-alloyed material up to 800 N/mm².
 Colour: black.

Ø 13.5 mm - Ø 16 mm = 10 mm shank / Ø 16.5 mm - Ø 20 mm = 13 mm shank.

Diameter (mm)	Total length (mm) A	Working length (mm) B	Pack quantity	Min. order quantity	Article Number	EAN Code
13.5	160	108	1	1	4932373318	4002395348435
14.0	160	108	1	1	4932373319	4002395348442
14.5	169	108	1	1	4932373320	4002395348459
15.0	169	114	1	1	4932373321	4002395348466
15.5	178	120	1	1	4932373322	4002395348473
16.0	178	120	1	1	4932373323	4002395348480
16.5	184	125	1	1	4932373324	4002395348497
17.0	184	125	1	1	4932373325	4002395349104
17.5	191	130	1	1	4932373326	4002395349111
18.0	191	130	1	1	4932373327	4002395349128
18.5	198	135	1	1	4932373328	4002395349135
19.0	198	135	1	1	4932373329	4002395349142
19.5	205	140	1	1	4932373330	4002395349159
20.0	205	140	1	1	4932373331	4002395349166



TiD-extra
Industrial Technologies d.o.o.

Metal drill bits HSS rollforged - DIN 338 - 345 pc cabinet

Diameter (mm)	Total length (mm) A	Working length (mm) B	Pack quantity	Min. order quantity	Article Number	EAN Code
Metal drill bit cabinet with HSS rollforged metal drill bits (345pc)			345	1	4932352674	4002395373321
1.0	34	12	20			
1.5	40	18	20			
2	49	24	20			
2.5	57	30	20			
3	61	33	20			
3.5	70	39	20			
4	75	43	20			
4.5	80	47	20			
5	86	52	20			
5.5	93	57	20			
6	93	57	20			
6.5	101	63	20			
7	109	69	10			
7.5	109	69	10			
8	117	75	20			
8.5	117	75	10			
9	125	81	10			
9.5	125	81	5			
10	133	87	10			
10.5	133	87	5			
11	142	94	5			
11.5	142	94	5			
12	151	101	5			
12.5	151	101	5			
13	151	101	5			



THUNDERWEB

Metal drill bits HSS Ground - DIN 338



THUNDERWEB

The **THUNDERWEB** design is characterised by a conical shaped web which gets thicker towards the back of the drill bit. The web is the internal core of the drill bit.

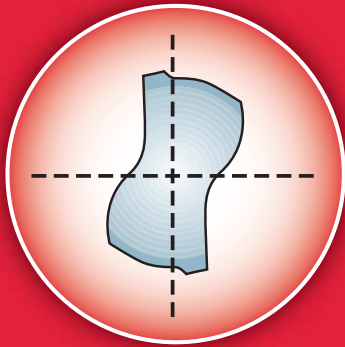

Parabolic web cross section

- Large web thickness. Strength built in.
- Accepts higher feed pressure and torque.
- Less breakages. Good for drilling deep holes and on curved surfaces.
- Long life.

Standard drill bit

The web on standard drill bits is a constant thickness throughout the length of the bit.

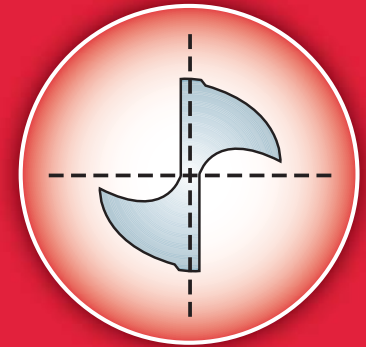

Conventional type web cross section



THUNDERWEB SPECIFICATION

FLUTE GEOMETRY

- **THUNDERWEB** flute form ejects hot chips rapidly. Dissepates heat better increasing lifetime.
- Open flute form reduces drill drawback when drilling deeper holes.
- Sharpened edges reduce binding for faster cleaner cuts.
- Flatter twist angle creates smaller chippings, ideal for drilling harder steels ie. stainless steel.

135° SPLIT POINT

- Precision starting, drill bit won't walk.
- Penetrates quickly.
- Good for drilling on curved surfaces.
- Requires less effort/feed pressure.
- Excellent for very hard materials.



THUNDERWEB - HSS-Ground metal drill bits - DIN338

Diameter (mm)	Total length (mm) A	Working length (mm) B	Pack quantity	Min. order quantity	Article Number	EAN Code
1.0	34	12	2	1	4932352345	4002395370047
1.5	40	18	2	1	4932352346	4002395370054
2.0	49	24	2	1	4932352347	4002395370061
2.5	57	30	2	1	4932352348	4002395370078
3.0	61	33	2	1	4932352349	4002395370085
3.2	65	36	2	1	4932352350	4002395370092
3.5	70	39	2	1	4932352351	4002395370108
4.0	75	43	2	1	4932352352	4002395370115
4.2	75	43	1	1	4932352353	4002395370122
4.5	80	47	1	1	4932352354	4002395370139
4.8	86	52	1	1	4932352355	4002395370146
5.0	86	52	1	1	4932352356	4002395370153
5.5	93	57	1	1	4932352357	4002395370160
6.0	93	57	1	1	4932352358	4002395370177
6.5	101	63	1	1	4932352359	4002395370184
6.8	109	69	1	1	4932352360	4002395370191
7.0	109	69	1	1	4932352361	4002395370207
7.5	109	69	1	1	4932352362	4002395370214
8.0	117	75	1	1	4932352363	4002395370221
8.5	117	75	1	1	4932352364	4002395370238
9.0	125	81	1	1	4932352365	4002395370245
9.5	125	81	1	1	4932352366	4002395370252
10.0	133	87	1	1	4932352367	4002395370269
10.5	133	87	1	1	4932352368	4002395370276
11.0	142	94	1	1	4932352369	4002395370283
11.5	142	94	1	1	4932352370	4002395370290
12.0	151	101	1	1	4932352371	4002395370306
12.5	151	101	1	1	4932352372	4002395370313
13.0	151	101	1	1	4932352373	4002395370320

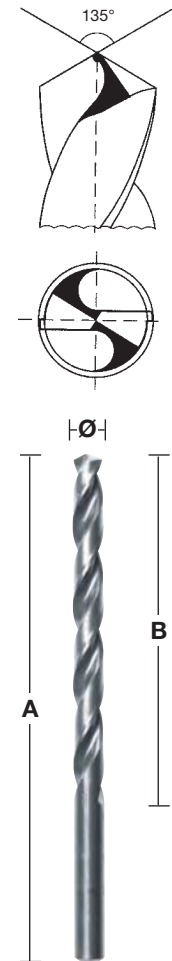

THUNDERWEB - DIN 338 - 5 and 10 pack

Diameter (mm)	Total length (mm)	Working length (mm)	Pack quantity	Min. order quantity	Article Number	EAN Code
1	34	12	10	1	4932352377	4002395370368
1.1	36	14	10	1	4932459826	4058546029982
1.2	38	16	10	1	4932459827	4058546029999
1.3	38	16	10	1	4932459828	4058546030001
1.4	40	18	10	1	4932459829	4058546030018
1.5	40	18	10	1	4932352378	4002395370375
1.6	43	20	10	1	4932459830	4058546030025
1.7	43	20	10	1	4932459831	4058546030032
1.8	46	22	10	1	4932459832	4058546030049
1.9	46	22	10	1	4932459833	4058546030056
2	49	24	10	1	4932352379	4002395370382
2.1	49	24	10	1	4932459834	4058546030063
2.2	53	27	10	1	4932459835	4058546030070
2.3	53	27	10	1	4932459836	4058546030087
2.4	57	30	10	1	4932430569	4002395382309
2.5	57	30	10	1	4932352380	4002395370399
2.6	57	30	10	1	4932459837	4058546030094
2.7	61	33	10	1	4932459838	4058546030100
2.8	61	33	10	1	4932459839	4058546030117
2.9	61	33	10	1	4932459840	4058546030124
3	61	33	10	1	4932352381	4002395370405
3.1	65	36	10	1	4932459841	4058546030131
3.2	65	36	10	1	4932352382	4002395370412
3.3	65	36	10	1	4932459842	4058546030148
3.4	70	39	10	1	4932459843	4058546030155



THUNDERWEB - DIN 338 - 5 and 10 pack

Diameter (mm)	Total length (mm)	Working length (mm)	Pack quantity	Min. order quantity	Article Number	EAN Code
3.5	70	39	10	1	4932352383	4002395370429
3.6	70	39	10	1	4932459844	4058546030162
3.7	70	39	10	1	4932459845	4058546030179
3.8	75	43	10	1	4932430547	4002395382088
3.9	75	43	10	1	4932459846	4058546030186
4	75	43	10	1	4932352384	4002395370436
4.1	75	43	10	1	4932459847	4058546030193
4.2	75	43	10	1	4932352385	4002395370443
4.3	80	47	10	1	4932459848	4058546030209
4.4	80	47	10	1	4932459849	4058546030216
4.5	80	47	10	1	4932352386	4002395370450
4.6	80	47	10	1	4932459850	4058546030223
4.7	80	47	10	1	4932459851	4058546030230
4.8	86	52	10	1	4932352387	4002395370467
4.9	86	52	10	1	4932459852	4058546030247
5	86	52	10	1	4932352388	4002395370474
5.1	86	52	10	1	4932459853	4058546030254
5.2	86	52	10	1	4932430548	4002395382095
5.3	86	52	10	1	4932459854	4058546030261
5.4	93	57	10	1	4932459855	4058546030278
5.5	93	57	10	1	4932352389	4002395370481
5.6	93	57	10	1	4932430570	4002395382316
5.7	93	57	10	1	4932459856	4058546030285
5.8	93	57	10	1	4932430549	4002395382101
5.9	93	57	10	1	4932459857	4058546030292
6	93	57	10	1	4932352390	4002395370498
6.1	101	63	10	1	4932459858	4058546030308
6.2	101	63	10	1	4932430550	4002395382118
6.3	101	63	10	1	4932459859	4058546030315
6.4	101	63	10	1	4932430571	4002395382323
6.5	101	63	10	1	4932352391	4002395370504
6.6	101	63	5	1	4932459860	4058546030322
6.7	101	63	5	1	4932459861	4058546030339
6.8	109	69	5	1	4932352392	4002395370511
6.9	109	69	5	1	4932459862	4058546030346
7	109	69	5	1	4932352393	4002395370528
7.1	109	69	5	1	4932459863	4058546030353
7.2	109	69	5	1	4932430551	4002395382125
7.3	109	69	5	1	4932459864	4058546030360
7.4	109	69	5	1	4932459865	4058546030377
7.5	109	69	5	1	4932352394	4002395370535
7.6	117	75	5	1	4932459866	4058546030384
7.7	117	75	5	1	4932459867	4058546030391
7.8	117	75	5	1	4932459868	4058546030407
7.9	117	75	5	1	4932459869	4058546030414
8	117	75	5	1	4932352395	4002395370542
8.1	117	75	5	1	4932459870	4058546030421
8.2	117	75	5	1	4932430552	4002395382132
8.3	117	75	5	1	4932459871	4058546030438
8.4	117	75	5	1	4932430553	4002395382149
8.5	117	75	5	1	4932352396	4002395370559
8.6	125	81	5	1	4932459872	4058546030445
8.7	125	81	5	1	4932459873	4058546030452
8.8	125	81	5	1	4932459874	4058546030469
8.9	125	81	5	1	4932459875	4058546030476
9	125	81	5	1	4932352397	4002395370566
9.1	125	81	5	1	4932459876	4058546030483
9.2	125	81	5	1	4932459877	4058546030490
9.3	125	81	5	1	4932459878	4058546030506
9.4	125	81	5	1	4932459879	4058546030513
9.5	125	81	5	1	4932352398	4002395370573
9.6	133	87	5	1	4932459880	4058546030520
9.7	133	87	5	1	4932459881	4058546030537
9.8	133	87	5	1	4932459882	4058546030544



THUNDERWEB - DIN 338 - 5 and 10 pack

Diameter (mm)	Total length (mm)	Working length (mm)	Pack quantity	Min. order quantity	Article Number	EAN Code
9.9	133	87	5	1	4932459883	4058546030551
10	133	87	5	1	4932352399	4002395370580
10.5	133	87	5	1	4932352400	4002395370597
11	142	94	5	1	4932352401	4002395370603
11.5	142	94	5	1	4932352402	4002395370610
12	151	101	5	1	4932352403	4002395370627
12.5	151	101	5	1	4932352404	4002395370634
13	151	101	5	1	4932352405	4002395370641



THUNDERWEB - DIN 338 - cassettes

Description	Supplied in	Pack quantity	Min. order quantity	Article Number	EAN Code
THUNDERWEB HSS-G set (19pc)					
① Ø 1 / 1.5 / 2 / 2.5 / 3 / 3.5 / 4 / 4.5 / 5 / 5.5 / 6 / 6.5 / 7 / 7.5 / 8 / 8.5 / 9 / 9.5 / 10 mm	Plastic cassette	19	1	4932352374	4002395370337
Counter display					
② 6 x 19 pc HSS-G drill bits set (4932352374)	-	6	1	4932352375	4002395370344
THUNDERWEB HSS-G set (25pc)					
③ Ø 1 / 1.5 / 2 / 2.5 / 3 / 3.5 / 4 / 4.5 / 5 / 5.5 / 6 / 6.5 / 7 / 7.5 / 8 / 8.5 / 9 / 9.5 / 10 / 10.5 / 11 / 11.5 / 12 / 12.5 / 13 mm	Plastic cassette	25	1	4932352376	4002395370351



TID-extra
Industrial Technologies d.o.o.

HSS-G metal drill bits - long - DIN 340 - 5 and 10 pack

High quality high speed steel.
Split point DIN 1412 C.
Right hand cutting edge.
135° angle for improved centering.
Most suitable for drilling deep holes in channels or where there are hollow sections.

Diameter (mm)	Total length (mm) A	Working length (mm) B	Pack quantity	Min. order quantity	Article Number	EAN Code
2.0	85	56	10	1	4932430328	4002395379987
2.5	95	62	10	1	4932430329	4002395379903
3.0	100	66	10	1	4932430330	4002395379910
3.5	112	73	10	1	4932430331	4002395379927
4.0	119	78	10	1	4932430332	4002395379934
4.5	126	82	10	1	4932430333	4002395379941
5.0	132	87	10	1	4932430334	4002395379958
5.5	139	91	10	1	4932430335	4002395379965
6.0	139	91	10	1	4932430336	4002395379972
6.5	148	97	10	1	4932430337	4002395379989
7.0	156	102	10	1	4932430338	4002395379996
8.0	165	109	10	1	4932430339	4002395380008
9.0	175	115	10	1	4932430340	4002395380015
10.0	184	121	10	1	4932430341	4002395380022
11.0	195	128	5	1	4932430342	4002395380039
12.0	205	134	5	1	4932430343	4002395380046
13.0	205	134	5	1	4932430344	4002395380053

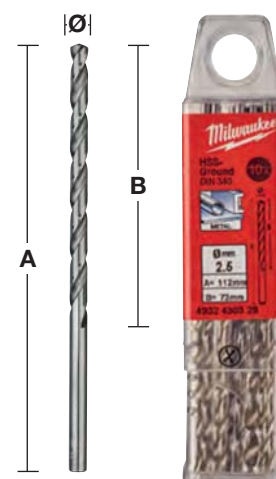

HSS-G metal drill bits - short - DIN 1897 - 5 and 10 pack

Drill bit quality: High quality high speed steel. Tip geometry: Split Point DIN 1412 C. Point angle: 135°. Tolerance: h8. Flute / Helix angle: Type N flute and normal 20 - 30° angle. Right hand cutting edge. Surface / Colour: Polished silver. Withstands high drill point pressure due to short overall length. Excellent concentricity. Polished type N flute with right hand cutting edge, eliminates binding for faster chip removal and faster cutting with less effort. Application: Most suited for drilling sheet and thin walled materials. Suitable for drilling in sheet steel, thin alloyed and non-alloyed material up to 900 N/mm². Also suitable for wood and plastics.

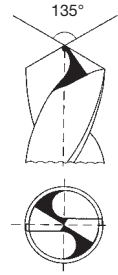

Diameter (mm)	Total length (mm) A	Working length (mm) B	Pack quantity	Min. order quantity	Article Number	EAN Code
2.0	38	12	10	1	4932352200	4002395368532
2.5	43	14	10	1	4932352201	4002395368549
3.0	46	16	10	1	4932352202	4002395368556
3.2	49	18	10	1	4932352203	4002395368563
3.3	49	18	10	1	4932352204	4002395368570
3.5	52	20	10	1	4932352205	4002395368587
3.7	52	20	10	1	4932352206	4002395368594
4.0	55	22	10	1	4932352207	4002395368600
4.2	55	22	10	1	4932352208	4002395368617
4.5	58	24	10	1	4932352209	4002395368624
4.8	62	26	10	1	4932352210	4002395368631
5.0	62	26	10	1	4932352211	4002395368648
5.2	62	26	10	1	4932352212	4002395368655
5.5	66	28	10	1	4932352213	4002395368662
6.0	66	28	10	1	4932352214	4002395368679
6.5	70	31	10	1	4932352215	4002395368686
7.0	74	34	10	1	4932352216	4002395368693
7.5	74	34	5	1	4932352217	4002395368709
8.0	79	37	5	1	4932352218	4002395368716
8.5	79	37	5	1	4932352219	4002395368723
9.0	84	40	5	1	4932352220	4002395368730
10.0	89	43	5	1	4932352221	4002395368747

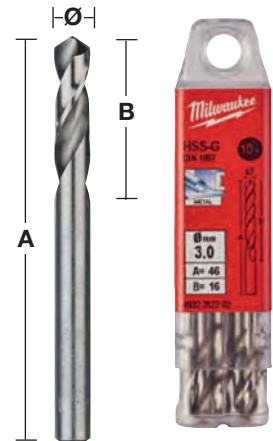

HSS-G metal drill bits - double ended - 10 pack

Drill bit quality: High quality high speed steel. Tip geometry: Split Point DIN 1412 C. Point angle: 135°. Tolerance: h8. Flute / Helix angle: Type N flute and normal 20 - 30° angle. Right hand cutting edge. Surface / Colour: Polished silver. Split point tip for good centering. Both ends can be used. Due to its short length it can be used with higher feed pressure without the risk of breakage. Excellent concentricity. Polished type N flute with right hand cutting edge, eliminates binding for faster chip removal and faster cutting with less effort. Application: Suitable drilling in steel, non-ferrous metals and plastic. Most suitable for thin sheet materials e.g. rivet holes.

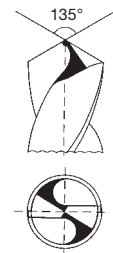

Diameter (mm)	Total length (mm) A	Working length (mm) B	Pack quantity	Min. order quantity	Article Number	EAN Code
2.5	43	10	10	1	4932352222	4002395368754
3.0	46	11	10	1	4932352223	4002395368761
3.2	49	12	10	1	4932352224	4002395368778
3.3	49	12	10	1	4932352225	4002395368785
3.5	52	14	10	1	4932352226	4002395368792
4.0	55	14	10	1	4932352227	4002395368808
4.1	55	14	10	1	4932352228	4002395368815
4.2	55	14	10	1	4932352229	4002395368822
4.5	58	16	10	1	4932352230	4002395368839
4.8	62	18	10	1	4932352231	4002395368846
5.0	62	18	10	1	4932352232	4002395368853
5.5	66	19	10	1	4932352233	4002395368860
6.0	66	19	10	1	4932352234	4002395368877

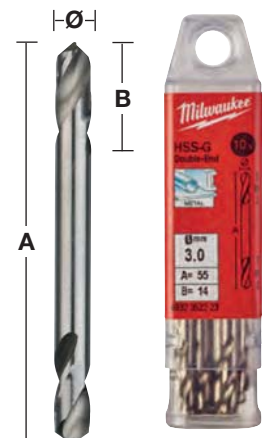

HIGH PERFORMANCE DRILL BITS

NEXT GENERATION*

RED HEX

HSS-TIN METAL DRILL BITS

SHOCKWAVE  **IMPACT DUTY**

RED COBALT

HSS-CO METAL DRILL BITS

TiD-extra
Industrial Technologies d.o.o.



1/4"

FOR IMPACTS AND DRILLS



3 FLAT



INOX



QUAD EDGE™ TIP



VARIABLE FLUTE



ENHANCED TAPERED WEB

RED HEX & RED COBALT SPECIFICATIONS

QUAD EDGE™ TIP

- Unique combination of 135° split point and four cutting edges.
- Allows for precise and fast drilling start without walking.
- Four cutting edges create smaller chips to prevent heat build up to ensure longer life.

VARIABLE FLUTE GEOMETRY

- Faster material ejection.
- Helps the bit run cooler and prevent it from burning out faster.

ENHANCED TAPERED WEB

- Wider core towards the shank of the drill bit.
- Strengthens the core to increase overall flute durability.

Quad Edge™ Tip on sizes > Ø 4.5 mm. 3-Flat on HSS-Co sizes > Ø 5 mm.
*Full range available by 2nd half 2021.



RED HEX - SHOCKWAVE™ HSS-TiN metal drill bits

Impact rated drill bit with 1/4" hex shank optimised for impact drivers.

Titanium Nitride coating dispenses heat and makes the drill bit suitable for use also in high speed.

Diameter (mm)	Total length (mm) A	Working length (mm) B	Pack quantity	Min. order quantity	Article Number	EAN Code
2	59.5	17	2	1	48894703	045242501557
2.5	62	19	2	1	48894704	045242501564
3	65	23	2	1	48894763	045242506866
3.2	66.5	23	2	1	48894706	045242501571
3.3	67	24	2	1	4932471089	4058546287177
3.5	69	25	2	1	48894707	045242501588
4	71.5	26	2	1	48894708	045242501595
4.2	74	28	1	1	48894709	045242501601
4.5	76	29	1	1	48894710	045242501618
4.8	78	29	1	1	48894711	045242501625
5	80	31	1	1	48894712	045242501632
5.5	104	60	1	1	48894764	045242506873
6	105	63	1	1	48894714	045242501649
6.5	107	64	1	1	48894715	045242501656
6.8	108	65	1	1	48894716	045242501663
7	109	66	1	1	48894717	045242501670
7.5	110	67	1	1	48894718	045242501687
8	111	70	1	1	48894719	045242501694
8.5	114	72	1	1	48894720	045242501700
9	117	73	1	1	48894721	045242501717
9.5	118	74	1	1	48894722	045242501724
10	120	76	1	1	48894723	045242501731
10.2	121	77	1	1	4932471090	4058546287184
10.5	122	78	1	1	48894724	045242501748
11	125	80	1	1	48894725	045242501755
11.5	126	81	1	1	48894726	045242501762
12	127	82	1	1	48894727	045242501779
12.5	128	83	1	1	48894728	045242501786
13	130	83	1	1	48894729	045242501793

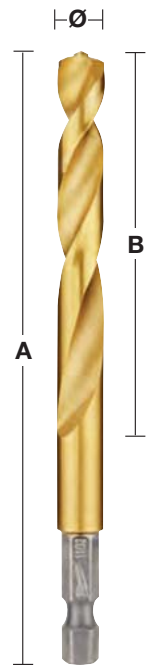
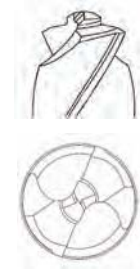

①	SHOCKWAVE™ HSS-G TiN Red Hex drill bits set (10pc)	10	6	48894759	045242502066
	Ø 3 / 3.5 / 4 / 4.5 / 5 / 6 / 7 / 8 / 9 / 10 mm				

②	SHOCKWAVE™ HSS-G TiN Red Hex drill bit set (19pc)	19	6	48894760	045242502073
	Ø 2 / 2.5 / 2 x 3 / 3.5 / 2 x 4 / 4.5 / 5 / 5.5 / 6 / 6.5 / 7 / 7.5 / 8 / 8.5 / 9 / 9.5 / 10 mm				

Diameter (mm)	Total length (mm) A	Working length (mm) B	Pack quantity	Min. order quantity	Article Number	EAN Code
2.5	62	19	10	1	4932478175	4058546341084
3.0	65	23	10	1	4932478176	4058546341091
3.5	69	25	10	1	4932478177	4058546341107
4.0	71.5	26	10	1	4932478178	4058546341114
4.5	76	29	10	1	4932478179	4058546341121
5.0	80	31	10	1	4932478180	4058546341138
6.0	105	63	10	1	4932478181	4058546341145
7.0	109	66	5	1	4932478182	4058546341152
8.0	111	70	5	1	4932478183	4058546341169
10.0	120	76	5	1	4932478184	4058546341176

RED COBALT - HSS-Ground - DIN 338 Cobalt metal drill bits

Metal drill bits ground from solid, extremely heat resistant 5% cobalt-alloyed high speed steel produced according to DIN 338.

Suitable for drilling high alloy content steels and metals with tensile strengths over 1000 N/mm² like stainless steel.

QUAD EDGE™ Tip: unique combination of 135° split point and four cutting edges: 135° split point allows for precise & fast drilling start without walking. Four cutting edges create smaller chips to prevent heat build up for longer life.

Variable flute geometry: For faster material ejection. Helps the bit run cooler and prevent it from burning out faster.

Enhanced tapered web: Wider core towards the shank of the drill bit. Strengthens the core to increase overall flute durability.

3-flat shank from Ø 5 mm for better grip and prevents chuck slippage.

Colour: bronze.

RED COBALT

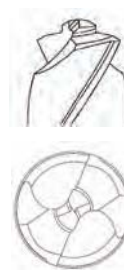

Diameter (mm)	Total length (mm) A	Working length (mm) B	Pack quantity	Min. order quantity	Article Number	EAN Code
1.0	34	12	2	1	4932363248	4002395333080
1.5	40	18	2	1	4932363249	4002395333097
2.0	49	24	2	1	4932363250	4002395333103
2.5	57	30	2	1	4932363251	4002395333110
3.0	61	33	2	1	4932363253	4002395333134
3.2	65	36	2	1	4932363254	4002395333141
3.3	67	37	2	1	4932471140	4058546287689
3.5	70	39	2	1	4932363256	4002395333165
4.0	75	43	2	1	4932363258	4002395333189
4.2	75	43	1	1	4932363260	4002395333202
4.5	80	47	1	1	4932363262	4002395333226
4.8	86	52	1	1	4932363263	4002395333233
5.0	86	52	1	1	4932363264	4002395333240
5.5	93	57	1	1	4932363267	4002395333271
6.0	93	57	1	1	4932363268	4002395333288
6.5	101	63	1	1	4932363269	4002395333295
6.8	109	69	1	1	4932363270	4002395333301
7.0	109	69	1	1	4932363271	4002395333318
7.5	109	69	1	1	4932363272	4002395333325
8.0	117	75	1	1	4932363274	4002395333349
8.5	117	75	1	1	4932363276	4002395333363
9.0	125	81	1	1	4932363277	4002395333370
9.5	125	81	1	1	4932363278	4002395333387
10.0	133	87	1	1	4932363279	4002395333394
10.2	133	87	1	1	4932471141	4058546287696
10.5	133	87	1	1	4932363281	4002395333417
11.0	142	94	1	1	4932363282	4002395333424
11.5	142	94	1	1	4932363283	4002395333431
12.0	151	101	1	1	4932363284	4002395333448
12.5	151	101	1	1	4932363285	4002395333455
13.0	151	101	1	1	4932363286	4002395333462

TiD-extra
Industrial Technologies d.o.o.

RED COBALT - HSS-Ground - DIN 338 Cobalt metal drill bits - sets

Description	Supplied in	Pack quantity	Min. order quantity	Article Number	EAN Code
RED COBALT HSS-Ground set (19pc)					
① Ø 1/1.5/2/2.5/3/3.5/4/4.5/5/5.5/6/6.5/7/7.5/8/8.5/9/9.5/10 mm	Plastic cassette	19	6	4932352470	4002395371297
RED COBALT HSS-Ground set (25pc)					
② Ø 1/1.5/2/2.5/3/3.5/4/4.5/5/5.5/6/6.5/7/7.5/8/8.5/9/9.5/10/10.5/11/11.5/12/12.5/13 mm	Plastic cassette	25	1	4932352471	4002395371303



RED COBALT - HSS-Ground - DIN 338 Cobalt metal drill bits - 5 and 10 pack

Metal drill bits ground from solid, extremely heat resistant 5% cobalt-alloyed high speed steel produced according to DIN 338.

Suitable for drilling high alloy content steels and metals with tensile strengths over 1000 N/mm² like stainless steel.

QUAD EDGE™ Tip: unique combination of 135° split point and four cutting edges: 135° split point allows for precise & fast drilling start without walking. Four cutting edges create smaller chips to prevent heat build up for longer life.

Variable flute geometry: For faster material ejection. Helps the bit run cooler and prevent it from burning out faster.

Enhanced tapered web: Wider core towards the shank of the drill bit. Strengthens the core to increase overall flute durability.

3-flat shank from Ø 5 mm for better grip and prevents chuck slippage.

RED COBALT

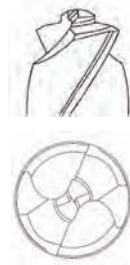

Diameter (mm)	Total length (mm) A	Working length (mm) B	Pack quantity	Min. order quantity	Article Number	EAN Code
1.0	34	12	10	1	4932373332	4002395349173
1.5	40	18	10	1	4932373333	4002395349180
2.0	49	24	10	1	4932373334	4002395349197
2.5	57	30	10	1	4932373335	4002395349807
3.0	61	33	10	1	4932373336	4002395349814
3.2	65	36	10	1	4932373337	4002395349821
3.3	67	37	10	1	4932471142	4058546287702
3.5	70	39	10	1	4932373338	4002395349838
4.0	75	43	10	1	4932373339	4002395349845
4.2	75	43	10	1	4932373340	4002395349852
4.5	80	47	10	1	4932373341	4002395349869
4.8	86	52	10	1	4932373342	4002395349876
5.0	86	52	10	1	4932373343	4002395349883
5.5	93	57	10	1	4932373344	4002395349890
6.0	93	57	10	1	4932373345	4002395347100
6.5	101	63	10	1	4932373346	4002395347117
6.8	109	69	5	1	4932373347	4002395347124
7.0	109	69	5	1	4932373348	4002395347131
7.5	109	69	5	1	4932373349	4002395347148
8.0	117	75	5	1	4932373350	4002395347155
8.5	117	75	5	1	4932373351	4002395347162
9.0	125	81	5	1	4932373352	4002395347179
9.5	125	81	5	1	4932373353	4002395347186
10.0	133	87	5	1	4932373354	4002395347193
10.2	133	87	5	1	4932471143	4058546287719
10.5	133	87	5	1	4932373355	4002395347803
11.0	142	94	5	1	4932373356	4002395347810
11.5	142	94	5	1	4932373357	4002395347827
12.0	151	101	5	1	4932373358	4002395347834
12.5	151	101	5	1	4932373359	4002395347841
13.0	151	101	5	1	4932373360	4002395347858



Step drills

- Step Drill advantages over conventional drill bits:
 - One drill bit to drill multiple sizes
 - Do more carry less! - Best option for enlarging existing holes.
 - More durable than twist drill bits, thick core resists breakage.
 - More accurate and less walking, tip starts on contact.
 - Clean burr free holes, less reaming required.
 - Drills plastic without splitting or cracking.

- Step drills are ideal for drilling into the following materials:
 - Ferrous & non-ferrous sheets metals, profiles and pipes.
 - Copper, brass and aluminium.
 - Stainless steel.
 - Plastics.
 - Maximum material thickness 4 mm.
 - To ensure best lifetime we recommend the use of a coolant.

- Trades:
 - Electrical: drilling of panels and cabinets for cable gland installation.
 - Plumbing / HVAC: access holes for pipework and installation.
 - Metal workers / fabrication: various sizes and hole enlargement.
 - Automotive: holes for cable installation (mobile telephones, antennas, re-directing electrical wiring).
 - Maintenance repair operations: various applications, sizes and hole enlargement.



MILWAUKEE® Advantages

Spot drill - Drill - Deburr - All in one go

- ① RAPID STRIKE TIP™: Accurate start without walking and fast drilling without the need to pre-drill the material.
- ② Special tip and step geometry for jam-free performance - less risk of drill snagging when used with high speed cordless tools and also prevents deformation of the drilled material.
- ③ Optimised 2 flute ground sharpened edge geometry for 2 x faster and smoother cutting.
- ④ Produced from custom engineered steel with black oxide coating for 4 x longer life. Optimised for use with high speed cordless drills.
- ⑤ Laser engraved size markings for best long term visibility.
- ⑥ Each step is relief ground to drill and deburr automatically.
- ⑦ With 3 flat secure grip to prevent step drill from slipping in the chuck and ensure maximum transmission of torque.



Step drills

	Description	Shank diameter (mm)	Overall length (mm)	No. of steps	Pack quantity	Min. order quantity	Article Number	EAN Code
①	PG7 - PG21	10	68	9	1	1	48899321	045242364060
②	M6 - M32	10	92	13	1	1	48899332	045242344437
③	4 - 12 mm / 1	6	65	9	1	1	48899301	045242342532
④	4 - 20 mm	8	65	9	1	1	48899320	045242344406
⑤	6 - 35 mm	10	90	14	1	1	48899335	045242344413
⑥	6 - 40.5 mm	10	90	17	1	1	48899340	045242547777
Step drill set (3pc)								
⑦	Includes 3 step drill bits: 4 - 12 mm/1, 4 - 20 mm, 6 - 35 mm				3	1	48899399	045242344420
Step & drill bit combo set (10pc)								
⑧	Includes 2 x step drill bits: 4 - 12 mm/1, 4 - 20 mm. THUNDERWEB metal drill bits: 2 x 2 mm, 2 x 3 mm, 2 x 4 mm, 1 x 5 mm, 1 x 6mm				10	1	48899350	045242538836

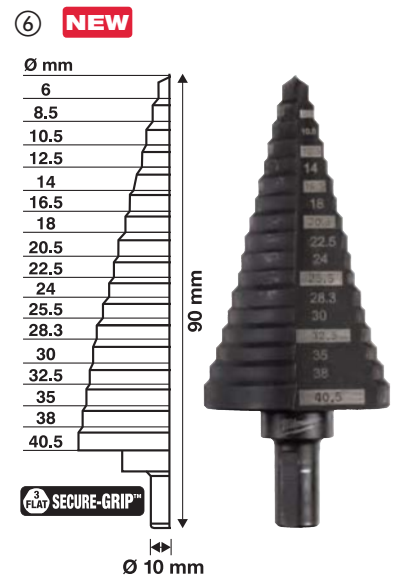
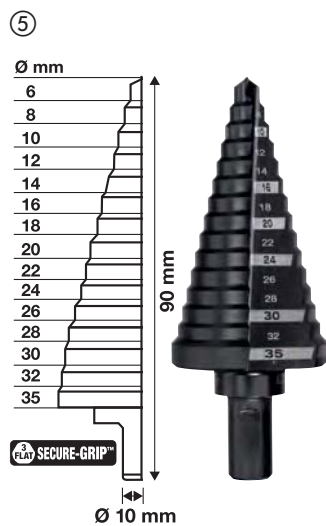
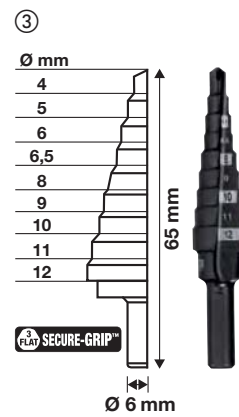
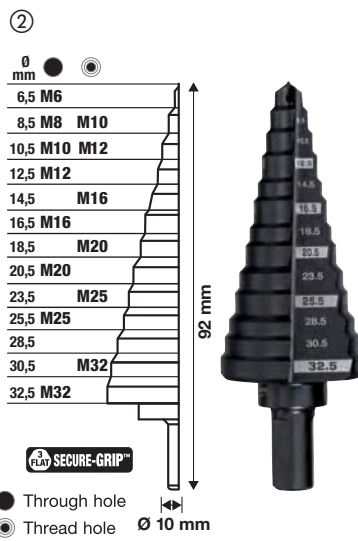

SHOCKWAVE™ IMPACT DUTY ™

SHOCKWAVE™ IMPACT DUTY step drills

SHOCKWAVE™ Impact Duty step drills are designed to deliver best-in-class performance in impact drivers and also the versatility to be used in drill drivers.

The 1/4" Hex shank with an optimised SHOCKZONE™ ensures maximum durability by preventing early shank breaks.

New Titanium Aluminium Nitride coating helps to reduce heat generation for 5x more life.

RAPID STRIKE TIP™: Accurate start without walking and fast drilling without the need to pre-drill the material.

Dual spiral flute design: Optimised for impact driver speed and for smooth, jam-free drilling.

Laser engraved markings: Do not wear away with time.



Description	Shank diameter (mm)	Overall length (mm)	No. of steps	Pack quantity	Min. order quantity	Article Number	EAN Code
① 4 - 12 mm / 1"	1/4" Hex	83	9	1	1	48899261	045242505166
② 4 - 12 mm / 2"	1/4" Hex	83	5	1	1	48899262	045242505173
③ 4 - 20 mm	1/4" Hex	83	9	1	1	48899263	045242505180
④ 4 - 30 mm	1/4" Hex	95	12	1	1	48899265	045242505203
⑤ SHOCKWAVE™ Impact Duty step drill set (3pc) Includes 3 SHOCKWAVE™ step drill bits: 4 - 12 mm/1, 4 - 20 mm, 4 - 30 mm				3	1	48899266	045242505210

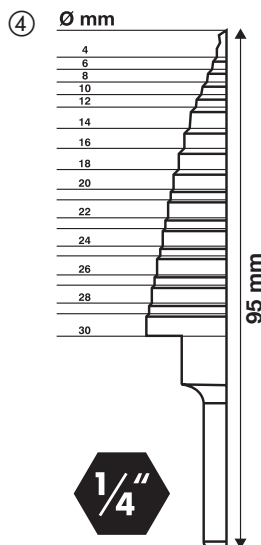
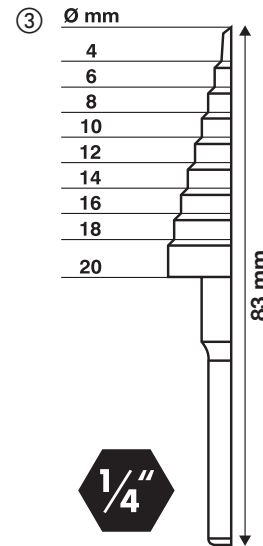
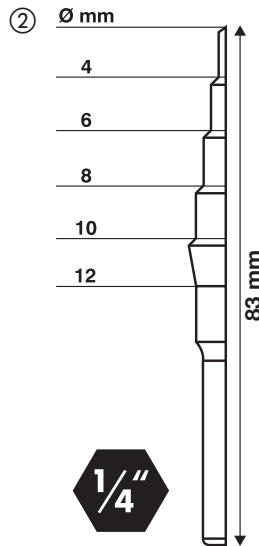
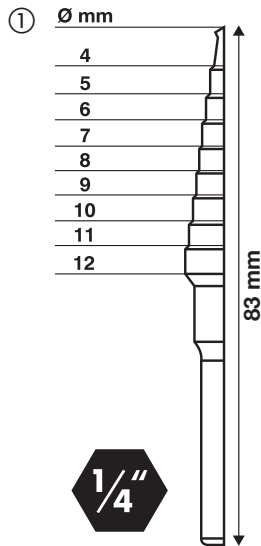

Magnetic Drilling

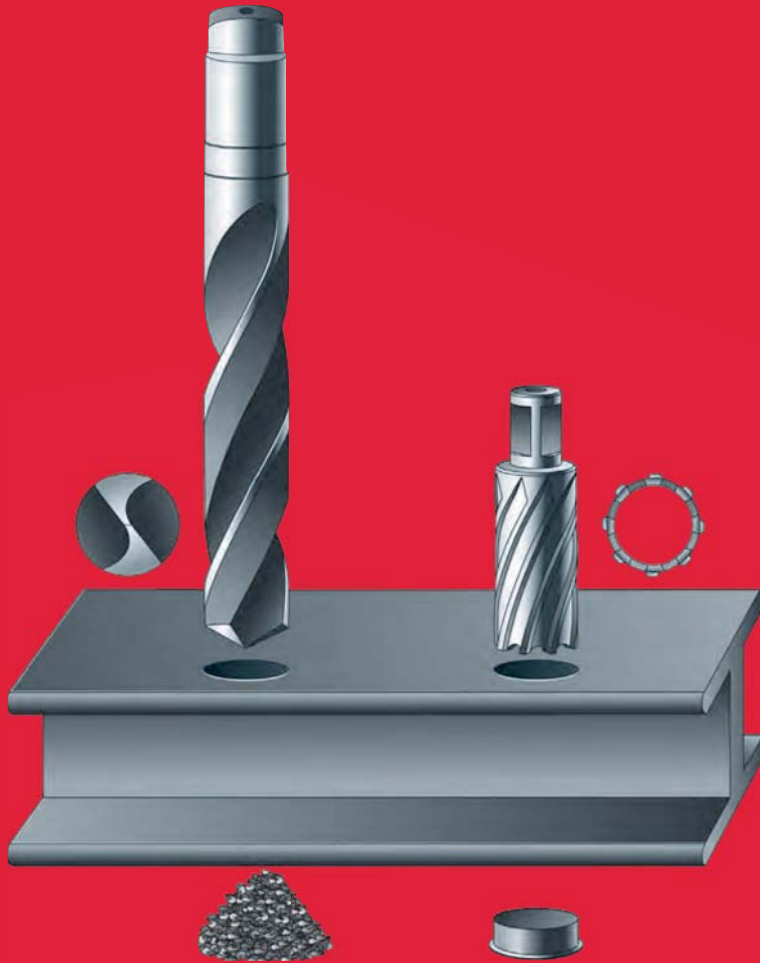

100% Faster

Speed and time savings are achieved due to the following factors. Firstly the annular cutter principle of only cutting material from the periphery of the hole as opposed to the twist drill which must cut the complete diameter of the hole. Secondly the benefit of two aggressive sharp angles per cutting edge help to achieve faster feed rates and lower cutting resistance.

30% More productivity

Because the annular cutter is only cutting material from the periphery of the hole. Less motor energy and driving power is required. The larger the drill diameter the greater the energy saving.

Longer lifetime

The annular cutters cutting edges do less work than the twist drill resulting in more holes between sharpening. Thick 6 mm body together with special tooth geometry ensures high stability and reduces to a minimum the risk of breakage due to overloading.

TiD-extra
Industrial Technologies d.o.o.

Speed chart

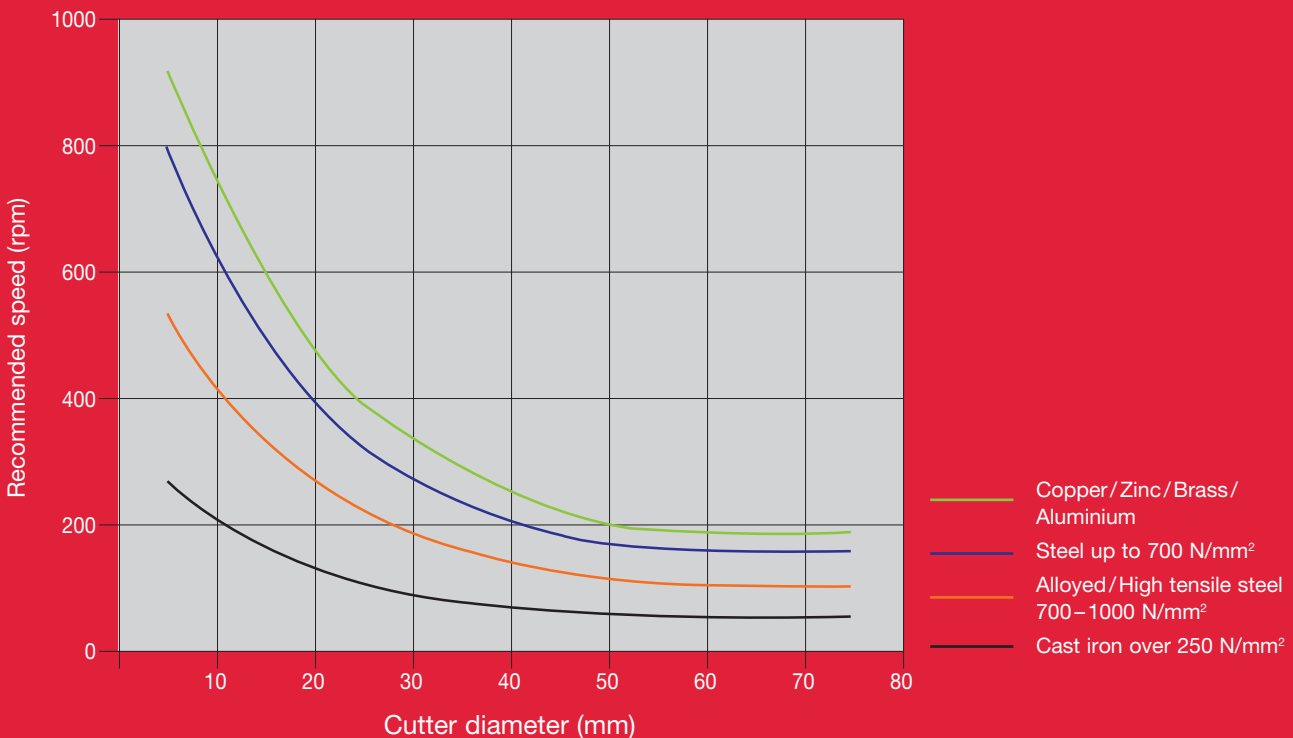

HSS annular cutters 30 mm

Thick walled HSS annular cutters for increased durability and life time. With standard 19 mm Weldon reception.

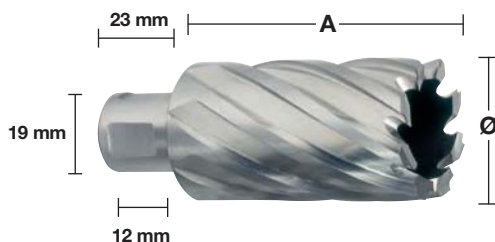

30 mm

Diameter (mm)	Total length (mm) A	Pack quantity	Min. order quantity	Article Number	EAN Code
12	30	1	1	4932371740	4002395344161
13	30	1	1	4932371741	4002395344178
14	30	1	1	4932343270	4002395315130
15	30	1	1	4932343271	4002395315147
16	30	1	1	4932343272	4002395315154
17	30	1	1	4932343273	4002395315161
18	30	1	1	4932343274	4002395315178
19	30	1	1	4932343275	4002395315185
20	30	1	1	4932343276	4002395315192
21	30	1	1	4932343277	4002395315208
22	30	1	1	4932343278	4002395315215
23	30	1	1	4932343279	4002395315222
24	30	1	1	4932343280	4002395315239
25	30	1	1	4932343281	4002395315246
26	30	1	1	4932343282	4002395315253
27	30	1	1	4932343283	4002395315260
28	30	1	1	4932343284	4002395315277
29	30	1	1	4932343285	4002395315284
30	30	1	1	4932343286	4002395315291
31	30	1	1	4932343287	4002395315307
32	30	1	1	4932343288	4002395315314
33	30	1	1	4932371742	4002395344185
34	30	1	1	4932371743	4002395344192
35	30	1	1	4932371744	4002395344208
36	30	1	1	4932371745	4002395344215
37	30	1	1	4932371746	4002395344222
38	30	1	1	4932371747	4002395344239
39	30	1	1	4932371748	4002395344246
40	30	1	1	4932371749	4002395344253
41	30	1	1	4932371750	4002395344260
42	30	1	1	4932371751	4002395344277
43	30	1	1	4932371752	4002395344284
44	30	1	1	4932371753	4002395344291
45	30	1	1	4932371754	4002395344307
46	30	1	1	4932371755	4002395344314
47	30	1	1	4932371756	4002395344321
48	30	1	1	4932371757	4002395344338
49	30	1	1	4932371758	4002395344345
50	30	1	1	4932371759	4002395344352

50 mm

Diameter (mm)	Total length (mm) A	Pack quantity	Min. order quantity	Article Number	EAN Code
14	50	1	1	4932343289	4002395315352
15	50	1	1	4932343290	4002395315369
16	50	1	1	4932343291	4002395315376
17	50	1	1	4932343292	4002395315383
18	50	1	1	4932343293	4002395315390
19	50	1	1	4932343294	4002395315406
20	50	1	1	4932343295	4002395315413
21	50	1	1	4932343296	4002395315420
22	50	1	1	4932343297	4002395315437
23	50	1	1	4932343298	4002395315444
24	50	1	1	4932343299	4002395315451
25	50	1	1	4932343300	4002395315468
26	50	1	1	4932343301	4002395315475
27	50	1	1	4932343302	4002395315482
28	50	1	1	4932343303	4002395315499
29	50	1	1	4932343304	4002395315505
30	50	1	1	4932343305	4002395315512
31	50	1	1	4932343306	4002395315529
32	50	1	1	4932343307	4002395315536
33	50	1	1	4932371760	4002395344369
34	50	1	1	4932371761	4002395344376
35	50	1	1	4932371762	4002395344383
36	50	1	1	4932371763	4002395344390
37	50	1	1	4932371764	4002395344406
38	50	1	1	4932371765	4002395344413
39	50	1	1	4932371766	4002395344420
40	50	1	1	4932371767	4002395344437
41	50	1	1	4932371768	4002395344444
42	50	1	1	4932371769	4002395344451
43	50	1	1	4932371770	4002395344468
44	50	1	1	4932371771	4002395344475
45	50	1	1	4932371772	4002395344482
46	50	1	1	4932371773	4002395344499
47	50	1	1	4932371774	4002395344505
48	50	1	1	4932371775	4002395344512
49	50	1	1	4932371776	4002395344529
50	50	1	1	4932371777	4002395344536

Description	Supplied in	Pack quantity	Min. order quantity	Article Number	EAN Code
Telescopic ejector pin for 30 mm cutters		2	1	49590011	045242364039
Telescopic ejector pin for 50 mm cutters		2	1	49590012	045242364046

HSS annular cutter set (6pc)

① 6 x HSS annular cutters: Ø 14 / 16 / 18 / 20 / 22 / 24 mm - 19 mm Weldon reception. 1 x ejector pin short series - 30 mm	Plastic case	6	1	4932372533	4002395345236
--	--------------	---	---	------------	---------------

System accessories - Magnetic drill stands



4932604226

**MDE/P 41
M18™ FMDP-502 C**



49590020

Arbor and
chuck



Metal drill
bits



48100130*

Drill pipe
adaptor

MD 38



1/2" x 20
48662125

Arbor and chuck
13 mm



Metal drill
bits

**MDE 42/MBE 1200
Reception 1/2" x 20 UNF**



4932267980

Keyed chuck
1.5-13 mm



4932371785

Oil feed
ring



19 mm Weldon
4932372781

Cutter arbor
(standard equipment)



4932371782

Oil cup
assembly



4932371788

Oil feed
arbor

19 mm Weldon



30 mm
Cutters (Short)



49590011

Telescopic ejector pin
(30 mm)

**MDE 4-85
Reception Morse taper 3**



19 mm Weldon
4932343310

Cutter arbor
(standard equipment)



4932371788

Oil feed
arbor

19 mm Weldon



50 mm
Cutters (Long)



49590012

Telescopic ejector pin
(50 mm)

**Ejector tool for
Morse taper**



B 16
4932117042

Chuck adaptor



4932127010

Keyed chuck
1-16 mm



Metal
drill bits

High Performance Holesaws

HOLE DOZER™

The MILWAUKEE® **HOLE DOZER™** is the jobsite workhorse that provides unstoppable durability through the most demanding applications.



Ø 14–152 mm



- Rip guard tooth geometry provides for the most durable tooth form and best lifetime



Ø 160–210 mm

PLUG JACK™

PLUG JACK™



ALL-ACCESS SLOT

- Multiple leverage points to work cut material out of the holesaw for faster plug removal
 - Deepest access for thick plugs
 - Higher access for thin material
- Minimises downtime between cuts
- New coating allows less friction and increases drilling speed



Tooth design

Carbide:

- 4 tpi aggressive tooth geometry.

Bi-metal:

- A variable 4-6 tpi tooth design with a positive 10° tooth angle.

Benefits:

- Faster and more aggressive cut.
- Improved heat dispersion during cutting ensures that the teeth stay sharper for longer.
- Deeper curved gullets provide more efficient chip clearance preventing clogging and heat build up.
- Special shaped tooth angle has less tendency to snag on thinner materials.
- Teeth are alternate/side set to minimise binding and friction.
- Requires less feed pressure – This is achieved by the combination of aggressive tooth geometry and good chip clearance resulting in the requirement of less force during drilling.

Holesaw body

- 1.27 mm thick steel holesaw body is rigid to retain its shape but also has built in elasticity.
- Effective sawing depth is 41 mm.

Applications

- High quality manufacturing techniques ensure high rotational precision, therefore these holesaws are suitable for use both in hand and pillar drills (manual feed only).
- This high quality holesaw range is the perfect solution for cutting all types of materials:
 - Steel up to 1000 N/mm² strength
 - Stainless steel and acid resistant steel
 - Non-ferrous metals
 - Cast iron
 - Aluminium
 - Wood
 - Medium density fibreboard (MDF)
 - Gypsum plasterboard
 - Sandwich materials
 - PVC

Tooth material

Carbide:

- Carbide teeth provide 10x more life vs. standard bi-metal holesaws.

Bi-Metal:

- Type Matrix II premium high speed steel is used for the toothed area of the holesaw. Matrix II steel contains 8 % cobalt allowing the teeth to retain the original tooth hardness even at high working temperatures when used in metal cutting applications.
- Bi-Metal construction – High speed steel teeth are laser welded onto a low alloy steel body. The teeth are then vacuum hardened to 65 HRC at a temperature of 600°C to give maximum durability and lifetime.
- Due to the high wear resistance of the Matrix II steel, these holesaws are ideal for cutting difficult and hard materials such as stainless steel and acid resistant steels as well as softer materials like wood.

Back plate design

- The back plates are constructed with thick steel thus the holes will not enlarge over time. Thick backs add strength and rigidity minimising vibrations.
- 4 drive pin holes for easier arbor location.
- Perfectly manufactured round back plate, especially important for the larger diameter holesaws.



HOLE DOZER™ carbide holesaws

Up to 10x more life, high heat and wear resistance compared to Bi-Metal holesaws

4 Tpi aggressive tooth geometry with large gullets for improved material removal

Offset teeth for less resistance

PLUG JACK™ slot geometry provides deep access to remove thick plugs and high leverage for thin materials

Application areas: metalworking (stainless steel, high alloy steels, aluminium) and composites (plastics, sandwich material, computer flooring, fibreglass, plastic coated wood boards, nail embedded wood)

Diameter (mm)	Ø (inch)	Max. cutting depth (mm)	Pack quantity	Min. order quantity	Article Number	EAN Code
19	3/4	41	1	1	49560702	045242503971
22	7/8	41	1	1	49560704	045242503995
25	1	41	1	1	49560707	045242504008
29	1 1/8	41	1	1	49560708	045242504015
32	1 1/4	41	1	1	49560710	045242504022
35	1 3/8	41	1	1	49560712	045242504039
38	1 1/2	41	1	1	49560713	045242504053
44	1 3/4	41	1	1	49560717	045242504107
48	1 7/8	41	1	1	49560719	045242504114
51	2	41	1	1	49560720	045242504145
54	2 1/8	41	1	1	49560722	045242504152
57	2 1/4	41	1	1	49560724	045242504169
60	2 3/8	41	1	1	49560726	045242504176
64	2 1/2	41	1	1	49560727	045242504183
67	2 5/8	41	1	1	49560729	045242504190
70	2 3/4	41	1	1	49560731	045242504206
76	3	41	1	1	49560734	045242504220
89	3 1/2	41	1	1	49560738	045242504244
92	3 5/8	41	1	1	49560739	045242504251
102	4	41	1	1	49560742	045242504275
108	4 1/4	41	1	1	49560744	045242504282
114	4 1/2	41	1	1	49560746	045242504299
127	5	41	1	1	49560748	045242504305
152	6	41	1	1	49560749	045242504312



HOLE DOZER[™] bi-metal holesaws

Diameter (mm)	Ø (inch)	Max. cutting depth (mm)	Pack quantity	Min. order quantity	Article Number	EAN Code
14	9/16	41	1	1	49560002	045242271061
16	5/8	41	1	1	49560012	045242192922
17	11/16	41	1	1	49560014	045242193639
19	3/4	41	1	1	49560023	045242192632
20	25/32	41	1	1	49560024	045242271016
21	13/16	41	1	1	49560027	045242192649
22	7/8	41	1	1	49560032	045242192878
24	15/16	41	1	1	49560037	045242192885
25	1	41	1	1	49560043	045242192526
27	1 1/16	41	1	1	49560047	045242192892
29	1 1/8	41	1	1	49560052	045242192939
30	1 3/16	41	1	1	49560057	045242192946
32	1 1/4	41	1	1	49560062	045242192977
33	1 5/16	41	1	1	49560067	045242192984
35	1 3/8	41	1	1	49560072	045242192991
37	1 7/16	41	1	1	49560077	045242193028
38	1 1/2	41	1	1	49560082	045242193035
40	1 9/16	41	1	1	49560087	045242193042
41	1 5/8	41	1	1	49560092	045242193073
43	1 11/16	41	1	1	49560097	045242193080
44	1 3/4	41	1	1	49560102	045242193097
46	1 13/16	41	1	1	49560107	045242193127
48	1 7/8	41	1	1	49560112	045242193134
50	1 31/32	41	1	1	49560113	045242271023
51	2	41	1	1	49560117	045242193141
52	2 1/16	41	1	1	49560122	045242193172
54	2 1/8	41	1	1	49560127	045242193189
56	4/6	41	1	1	49560129	045242504664
57	2 1/4	41	1	1	49560132	045242193196
59	2 5/16	41	1	1	49560137	045242193226
60	2 3/8	41	1	1	49560142	045242193233
64	2 1/2	41	1	1	49560147	045242193240
65	2 9/16	41	1	1	49560153	045242193271
67	2 5/8	41	1	1	49560158	045242193288
68	2 11/16	41	1	1	49560159	045242271030
70	2 3/4	41	1	1	49560163	045242193295
73	2 7/8	41	1	1	49560167	045242193325
76	3	41	1	1	49560173	045242193332
79	3 1/8	41	1	1	49560177	045242193349
83	3 1/4	41	1	1	49560183	045242193370
86	3 3/8	41	1	1	49560187	045242193387
89	3 1/2	41	1	1	49560193	045242193394
92	3 5/8	41	1	1	49560197	045242193431
95	3 3/4	41	1	1	49560203	045242193448
98	3 7/8	41	1	1	49560207	045242193479
102	4	41	1	1	49560213	045242193486
105	4 1/8	41	1	1	49560217	045242193493
108	4 1/4	41	1	1	49560223	045242193523
111	4 3/8	41	1	1	49560227	045242193530
114	4 1/2	41	1	1	49560233	045242193547
121	4 3/4	41	1	1	49560237	045242193578
127	5	41	1	1	49560243	045242193585
133	5 1/4	41	1	1	49560244	045242271078
140	5 1/2	41	1	1	49560247	045242193592
152	6	41	1	1	49560253	045242193622
160	6 5/16	38	1	1	4932399885	4002395365395
168	6 3/8	38	1	1	4932399886	4002395365401
177	6 31/32	38	1	1	4932399887	4002395365418
200	7 7/8	38	1	1	4932399888	4002395365425
210	8 9/32	38	1	1	4932399889	4002395365432



HOLE DOZER™ bi-metal holesaws - bulk packs

Diameter (mm)	Ø (inch)	Max. cutting depth (mm)	Pack quantity	Min. order quantity	Article Number	EAN Code
19	3/4	41	1	25	49565090	045242176199
20	25/32	41	1	25	49565091	045242528943
22	7/8	41	1	25	49565100	045242156375
25	1	41	1	25	49565110	045242156382
29	1 1/8	41	1	25	49565120	045242156399
30	1 3/16	41	1	25	49565125	045242243976
32	1 1/4	41	1	25	49565130	045242156412
35	1 3/8	41	1	25	49565140	045242156429
38	1 1/2	41	1	25	49565150	045242156436
41	1 5/8	41	1	25	49565152	045242176229
44	1 3/4	41	1	25	49565155	045242176267
51	2	41	1	25	49565160	045242156443
54	2 1/8	41	1	25	49565165	045242176366
57	2 1/4	41	1	25	49565167	045242176373
60	2 3/8	41	1	25	49565169	045242528950
64	2 1/2	41	1	25	49565170	045242156467
67	2 5/8	41	1	16	49565175	045242176380
68	2 11/16	41	1	16	49565178	045242528967
76	3	41	1	16	49565180	045242176397
89	3 1/2	41	1	9	49565190	045242176403
92	3 5/8	41	1	9	49565195	045242176410
102	4	41	1	9	49565200	045242176427
105	4 1/8	41	1	9	49565205	045242176434



HOLE DOZER[™] bi-metal holesaws - sets

Description	Pack quantity	Min. order quantity	Article Number	EAN Code
7 pc Hole Dozer[™] Holesaw set				
① 5 x holesaws: Ø 19, 22, 25, 29, 32 mm. Arbor for Ø 14 - 30 mm (49567010). Spacer and adaptor. 1/8" allen key	7	1	49224083	045242310760
Hole Dozer[™] holesaw set (10pc)				
② 6 x holesaws: Ø 25, 32, 40, 54, 68, 76 mm. Arbor for Ø 14 - 30 mm (49567010). Arbor for Ø 32 - 152 mm (49569100). 2 x pilot drill bits. 1/8" allen key	10	1	49224201	045242348091
Hole Dozer[™] holesaw set (14pc)				
③ 10 x holesaws: Ø 19, 22, 25, 29, 32, 35, 38, 44, 51, 57 mm. Arbor for Ø 14 - 30 mm (49567010). Arbor for Ø 32 - 152 mm (49569100). 2 x pilot drill bits. 1/8" allen key	14	1	49224152	045242271047
Hole Dozer[™] holesaw set (17pc)				
④ 13 x holesaws: Ø 20, 22, 25, 32, 40, 44, 51, 57, 64, 65, 67, 68, 76 mm. Arbor for Ø 14 - 30 mm (49567010). Arbor for Ø 32 - 152 mm (49569100). 2 x pilot drill bits. 1/8" allen key	17	1	49224102	045242271054
Kit box for holesaws				
⑤ Arbor with pilot drill bit (49567010). Arbor with pilot drill bit (49569100). 2 x Pilot drill bits. 1/8" allen key (49960060)	4	1	4932430327	4002395379880
Hole Dozer[™] PACKOUT[™] holesaw set (12pc)				
⑥ 10 x holesaws: Ø 20, 25, 32, 35, 40, 44, 51, 54, 68, 76 mm. Arbor for Ø 14 - 30 mm (49567010). Arbor for Ø 32 - 152 mm (49569100). 1/8" allen key	12	1	4932472248	4058546338947



Bi-Metal contractor holesaws

Optimised variable 4-6 tooth geometry for faster cutting and universal use.
 Bi-Metal teeth for best durability and increased wear resistance.
 For universal use: steel, non ferrous metals, wood, drywall plasterboard, plastics.

Diameter (mm)	Ø (inch)	Max. cutting depth (mm)	Pack quantity	Min. order quantity	Article Number	EAN Code
14	9/16	38	1	1	4932464671	4058546226169
16	5/8	38	1	1	4932464672	4058546226176
19	3/4	38	1	1	4932464673	4058546226183
20	29/32	38	1	1	4932464674	4058546226190
21	13/16	38	1	1	4932464675	4058546226206
22	7/8	38	1	1	4932464676	4058546226213
24	15/16	38	1	1	4932464677	4058546226220
25	1	38	1	1	4932464678	4058546226237
27	1 1/16	38	1	1	4932464679	4058546226244
29	1 1/8	38	1	1	4932464680	4058546226251
30	1 3/16	38	1	1	4932464681	4058546226268
32	1 1/4	38	1	1	4932464682	4058546226275
35	1 3/8	38	1	1	4932464683	4058546226282
38	1 1/2	38	1	1	4932464684	4058546226299
40	1 9/16	38	1	1	4932464685	4058546226305
43	1 11/16	38	1	1	4932464686	4058546226312
44	1 3/4	38	1	1	4932464687	4058546226329
48	1 7/8	38	1	1	4932464688	4058546226336
51	2	38	1	1	4932464689	4058546226343
54	2 1/8	38	1	1	4932464690	4058546226350
56	4/6	38	1	1	4932464691	4058546226367
57	2 1/4	38	1	1	4932464692	4058546226374
60	2 3/8	38	1	1	4932464693	4058546226381
64	2 1/2	38	1	1	4932464694	4058546226398
65	2 9/16	38	1	1	4932464695	4058546226404
67	2 5/8	38	1	1	4932464696	4058546226411
68	2 11/16	38	1	1	4932464697	4058546226428
70	2 3/4	38	1	1	4932464698	4058546226435
73	2 7/8	38	1	1	4932464699	4058546226442
76	3	38	1	1	4932464700	4058546226459
79	3 1/8	38	1	1	4932464701	4058546226466
83	3 1/4	38	1	1	4932464702	4058546226473
89	3 1/2	38	1	1	4932464703	4058546226480
92	3 5/8	38	1	1	4932464704	4058546226497
98	3 7/8	38	1	1	4932464705	4058546226503
102	4	38	1	1	4932464706	4058546226510
105	4 1/8	38	1	1	4932464707	4058546226527
114	4 1/2	38	1	1	4932464708	4058546226534
121	4 3/4	38	1	1	4932464709	4058546226541
127	5	38	1	1	4932464710	4058546226558
152	6	38	1	1	4932464711	4058546226565



Bi-Metal contractor holesaw - sets

Optimised variable 4/6 tooth geometry for faster cutting and universal use.
 Bi-Metal teeth for best durability and increased wear resistance.
 For universal use: steel, non-ferrous metals, wood, drywall plasterboard, plastics.

Description	Pack quantity	Min. order quantity	Article Number	EAN Code
Bi-metal contractor holesaw set (10pc)				
① 6 x Holesaws: Ø 25, 32, 40, 54, 68, 76 mm. 1x arbor for Ø 14 - 30 mm. 1 x arbor for Ø 32 - 152 mm. 2 x pilot drill bits. Allen key	10	1	4932464719	4058546226640
Bi-Metal contractor holesaw set (14pc)				
② 10 x Holesaws: Ø 19, 22, 25, 29, 32, 35, 38, 44, 51, 57 mm. 1 x arbor for Ø 14 - 30 mm. 1 x arbor for Ø 32 - 152 mm. 2 x pilot drill bits. Allen key	14	1	4932464720	4058546226657



System accessories - Holesaws

Description	Fits holesaw Ø	Shank reception	Holesaw or core reception	Pack quantity	Min. order quantity	Article Number	EAN Code
① Arbor	Ø 14-30 mm	9.5 mm Hex	½" x 20	1	1	49567010	045242200177
② Arbor	Ø 32-210 mm	9.5 mm Hex	¾" x 18	1	1	49567250	045242225798
③ Arbor	Ø 32-210 mm	11 mm Hex	¾" x 18	1	1	49569100	045242200832
④ SDS-Plus arbor	Ø 14-30 mm	SDS-Plus	½" x 20	1	1	4932471694	4058546295936
⑤ SDS-Plus arbor	Ø 32-210 mm	SDS-Plus	¾" x 18	1	1	4932471695	4058546295943
⑥ Extension - 330 mm long	-	9.5 mm Hex	-	1	1	48284008	045242225811
⑦ Extension - 300 mm long	-	11 mm Hex	-	1	1	48284006	045242122516
⑧ Pilot drill bit fits to all arbors Ø 6 mm and 89 mm length				1	1	49568010	045242200450
⑧ Pilot drill long bit fits to all arbors Ø 6 mm and 100 mm length				1	1	49568000	045242200351
⑨ Allen key ⅜" for all arbors				1	1	49960060	04524221455
Grub screw for arbors				1	1	06832712	4002395874354



Adjustable hole cutter

For cutting large diameter holes for air conditioning pipes, fans, downlights and ceiling speakers. Dust collection shroud for 100% dust free work when overhead drilling. Diameter is adjustable from 51 mm to 178 mm in 6.4 mm steps. Laser marked preset diameters at 51 - 178 mm. Suitable for use on drywall (max. 25 mm) and ceiling tile. Not suitable for OSB wood boards.

Description	Pack quantity	Min. order quantity	Article Number	EAN Code
Adjustable hole cutter				
① Pilot drill, 2 blades, QL arbor and dust collection shroud	5	1	49560260	045242350261
② QL arbor with ⅜" Hex reception. 75 mm long	1	1	48281000	045242122622
Replacement blade and pilot drill set (4pc)				
③ 1 x pilot drill bit, 2 x blades and 1 x allen key	4	1	49560290	045242346370



HOLE DOZER™ holesaws: Recommended cutting speed in RPM

Diameter (mm)	Ø (inch)	Metal	Cast Iron	Steel	Non ferrous metal	Aluminium	Wood	MDF
14	9/16	580	400	300	790	900	1500	750
16	5/8	550	365	275	730	825	1500	750
17	11/16	500	330	250	665	750	1500	750
19	3/4	460	300	230	600	690	1500	750
20	25/32	425	280	210	560	635	1500	750
21	13/16	425	280	210	560	635	1500	750
22	7/8	390	260	195	520	585	1500	750
23	29/32	370	250	185	500	550	1500	750
25	1	350	235	175	470	525	1500	750
27	1 1/16	325	215	160	435	480	1400	700
29	1 1/8	300	200	150	400	450	1400	700
30	1 3/16	285	190	145	380	425	1400	700
32	1 1/4	275	180	140	380	410	1400	700
33	1 5/16	260	175	135	345	390	1400	700
35	1 3/8	250	165	125	330	375	1400	700
37	1 7/16	240	160	120	315	360	1400	700
38	1 1/2	230	150	115	300	345	1400	700
40	1 9/16	220	145	110	290	330	1200	600
41	1 5/8	210	140	105	280	315	1200	600
43	1 11/16	205	135	100	270	305	1200	600
44	1 3/4	195	130	95	260	295	1200	600
46	1 13/16	190	125	95	250	285	1200	600
48	1 7/8	180	120	90	240	270	1200	600
50	1 31/32	175	120	85	230	260	1200	600
51	2	170	115	85	230	255	1200	600
52	2 1/16	165	110	80	220	245	1200	600
54	2 1/8	150	100	75	200	225	1000	500
56	4/6	145	100	75	195	225	1000	500
57	2 1/4	145	100	75	195	225	1000	500
59	2 5/16	145	100	75	195	225	1000	500
60	2 3/8	140	95	70	190	220	1000	500
63	2 31/64	135	90	65	180	205	900	450
64	2 1/2	135	90	65	180	205	900	450
65	2 9/16	130	85	65	175	200	800	400
68	2 11/16	125	80	60	160	185	800	400
73	2 7/8	120	80	60	160	180	800	400
76	3	115	75	55	150	170	700	350
79	3 1/8	110	70	55	140	165	700	350
83	3 1/4	105	50	40	140	155	700	350
86	3 3/8	100	45	30	130	150	500	250
89	3 1/2	95	45	30	130	145	500	250
92	3 5/8	95	60	45	120	140	500	250
95	3 3/4	90	60	45	120	135	500	250
98	3 7/8	90	60	45	120	135	500	250
102	4	85	55	40	110	130	400	200
105	4 1/8	80	55	40	110	120	400	200
111	4 3/8	80	50	40	100	120	300	150
114	4 1/2	75	50	35	100	105	300	150
121	4 3/4	75	50	35	95	95	300	150
127	5	65	45	30	90	90	200	100
133	5 1/4	60	40	25	85	85	200	100
140	5 1/2	60	40	25	85	85	200	100
146	5 3/4	55	35	25	75	75	200	100
152	6	55	35	25	75	75	200	100
160	6 5/16	50	30	25	60	60	150	75
168	6 3/8	50	30	25	55	55	150	75
177	6 31/32	45	25	25	55	55	150	75
200	7 7/8	40	25	25	50	50	100	50
210	8 9/32	40	20	25	50	50	100	50
	-	Cutting oil	Dry	Cutting oil	Cutting oil	Turpentine	Dry	Dry



Speed kills!

Operating at higher speeds than those recommended will shorten the life of the holesaw and produce very inefficient cutting.



Feed Pressure:

Variables in material, work configuration should be considered. Apply sufficient feed pressure to aid good chip re-removal. Reduce the pressure when the holesaw becomes hot or if the teeth start to clog with material. Insufficient feed pressure will dull tooth points prematurely but too much pressure can totally destroy teeth.



Cooling Lubricant:

Cutting oil serves two purposes when sawing in metals. It cools the saw and the work piece. It reduces heat and abrasion which can shorten cutting life. It also aids re-moving swarf from the cutting surface. Using a cooling lubricant will extend the life of your holesaw by 500%.

BIG HAWG[™] multi material holesaws

BIG HAWG[™] multi material holesaws are ideal for electricians, carpenters, kitchen fitters & all related heating, ventilation and plumbing trades.

Designed for use in a wide variety of materials:

Bricks* - suitable for both solid bricks and bricks with cavities.

Aerated concrete blocks*, lightweight aggregate blocks and breeze blocks.

Soft density lime-sandstone building blocks up to hardness of 30 N/mm².

Softwoods, chipboard, plywood, medium density fibreboard (MDF).

Plastics and plastic coated board (Contiboard).

* Not suitable for use in hard materials such as concrete, granite, medium to hard density lime-sandstone block, natural stone and hard brick over 30 N/mm² hardness.



Diameter (mm)	Max. cutting depth (mm)	No. of teeth	Pack quantity	Min. order quantity	Article Number	EAN Code
25	60	2	1	1	4932464921	4058546228668
30	60	2	1	1	4932464922	4058546228675
35	60	2	1	1	4932464923	4058546228682
44	60	2	1	1	4932464924	4058546228699
51	60	3	1	1	4932464925	4058546228705
54	60	3	1	1	4932464926	4058546228712
57	60	3	1	1	4932464927	4058546228729
65	60	3	1	1	4932464928	4058546228736
68	60	3	1	1	4932464929	4058546228743
70	60	3	1	1	4932464930	4058546228750
76	60	3	1	1	4932464931	4058546228767
82	60	3	1	1	4932464932	4058546228774
92	60	3	1	1	4932464933	4058546228781
102	60	3	1	1	4932464934	4058546228798
108	60	3	1	1	4932464935	4058546228804
117	60	3	1	1	4932464936	4058546228811
133	60	3	1	1	4932464937	4058546228828
159	60	3	1	1	4932464938	4058546228835



BIG HAWG[™] multi material holesaws - set

Description	Pack quantity	Min. order quantity	Article Number	EAN Code
BIG HAWG[™] multi material set (10 pc)				
6 x holesaws: Ø 35, 44, 51, 57, 68, 76 mm. 1 x arbor with pilot drill. 2 x pilot drill. 1 x diamond file. Allen key	10	1	4932464939	4058546228842



BIG HAWG[™] multi material - system accessories

Description	Pack quantity	Min. order quantity	Article Number	EAN Code
① BIG HAWG [™] multi material pilot drill	1	1	4932464940	4058546228859
② BIG HAWG [™] multi material arbor with pilot drill	1	1	4932464941	4058546228866
③ Pilot drill flat bit 3/8" for wood only	1	1	48271401	045242121397



HCS holesaws

Optimised 5 Tpi tooth geometry for clean cuts in soft materials.
For use in plastics and drywall plasterboard.

Diameter (mm)	Max. cutting depth (mm)	Pack quantity	Min. order quantity	Article Number	EAN Code
121	96	1	1	4932472076	4058546324728
127	96	1	1	4932472077	4058546324735
133	96	1	1	4932472078	4058546324742
138	96	1	1	4932472079	4058546324759
150	96	1	1	4932472080	4058546324766
168	96	1	1	4932472081	4058546324773
172	96	1	1	4932472082	4058546324780
177	96	1	1	4932472083	4058546324797
186	96	1	1	4932472084	4058546324803
210	96	1	1	4932472085	4058546324810
212	96	1	1	4932472086	4058546324827
226	96	1	1	4932472087	4058546324834



System accessories - HCS holesaws

System accessories to be used with HCS holesaws.

1. Arbor with pilot drill
2. Pilot drill

Description	Pack quantity	Min. order quantity	Article Number	EAN Code
① HCS holesaws arbor with pilot drill	1	1	4932472088	4058546324841
② HCS holesaw pilot drill Ø6 and 150 mm length	1	1	4932472089	4058546324858



IMPACT HOLESAWS



Optimised for use with cordless tools



- ① Thin wall
 - 8 TPI = smooth burr free holes
 - 0.6 mm thick = less resistance
- ② Shallow cup optimised for drilling thin metal
- ③ 8% Cobalt Bi-Metal for best durability and lifetime
- ④ Ejection spring auto ejects slugs
- ⑤ Stop shoulder prevents over drilling
- ⑥ 1/4" Hex shank = impact driver compatible

Suitability

Max. 2 mm steel, aluminium and stainless steel (max. 1.5 mm)

TID-extra
Industrial Technologies d.o.o.

SHOCKWAVE™ IMPACT DUTY holesaws

	Diameter (mm)	Pack quantity	Min. order quantity	Article Number	EAN Code
	19	1	1	49569805	045242321094
	22	1	1	49569810	045242321100
	25	1	1	49569815	045242321117
①	29	1	1	49569820	045242321124
	32	1	1	49569825	045242321131
	35	1	1	49569830	045242321148
	38	1	1	49569835	045242321155
②	SHOCKWAVE™ IMPACT DUTY holesaw set (3pc)		3	49224800	045242321162
	Ø 22 / 29 / 35 mm				
	Ejection spring and grub screw		1	4932430466	4002395381272
	Pilot drill bit with arbor		1	4932430477	4002395381388



DIAMOND MAX™ M14 DRY drill bits

Diamond grit continuous edge drills have been specifically developed for professionals that need to drill in extremely hard materials such as porcelain/gres/quarry tiles, cast iron or fibreglass where it is increasingly difficult to work with conventional drill bits. These drill bits guarantee excellent performance and superior lifetime even in the hardest of materials.

Dry bits: These diamond drill bits do not require the use of water for cooling purposes.

M14 thread: To fit directly onto an angle grinder.

Clean holes: Drills clean, precise holes without any perimeter scratches.

Lifetime: To ensure long lifetime, we use high grade diamond for fast cutting and a superior brazed bond matrix to give best durability.

Durability: Tough alloy body which does not bend or distort easily.

Easy slug ejection: Slug ejection slots on the larger sizes for greater leverage when removing tight slugs.



Diameter (mm)	Reception	Pack quantity	Min. order quantity	Article Number	EAN Code
5	M14	1	1	4932471758	4058546296575
6	M14	1	1	4932471759	4058546296582
8	M14	1	1	4932471760	4058546296599
10	M14	1	1	4932471761	4058546296605
12	M14	1	1	4932471762	4058546296612
14	M14	1	1	4932471763	4058546296629
16	M14	1	1	4932471764	4058546296636
18	M14	1	1	4932478276	4058546344535
20	M14	1	1	4932478277	4058546344542
32	M14	1	1	4932478279	4058546344566
35	M14	1	1	4932478280	4058546344573
40	M14	1	1	4932478281	4058546344580
44	M14	1	1	4932478282	4058546344597
51	M14	1	1	4932478283	4058546344603
55	M14	1	1	4932478284	4058546344610
68	M14	1	1	4932478285	4058546344627
75	M14	1	1	4932478286	4058546344634
102	M14	1	1	4932478287	4058546344641



Application areas

Ceramic tiles – all types hard and soft:
Porcelain/Gres/Quarry/Terrazzo/Marbel/
Artificial stone/Terracota/Agglomerate/
Glazed

Cast iron

Fibreglass / GRP

(Glass reinforced plastic)/Perspex



DIAMOND MAX™ diamond drill bit set (4pc)

①	Ø 6, 8, 10, 14 mm	4	1	4932471863	4058546297626
---	-------------------	---	---	------------	---------------

How to use:

- The diamond drills fit directly onto an angle grinder with M14 thread. Apply the spindle lock on the angle grinder and directly screw on the drill bits, tighten firmly with a spanner. If fitting the drill bit to the MILWAUKEE® spot polisher first fix the adaptor 4932 4720 90 to the tool and then screw the drill bit onto the adaptor. Tighten firmly with a spanner.
- If the tile is not fitted to a wall or floor ensure it is secured firmly with a clamp.
- Switch on the tool to full speed. Slowly approach the tile with the drill bit at a 20-30° angle with light pressure to avoid skating on the tile. Once the drill bit starts to cut into the tile and forms a groove, gradually raise the drill so that it is horizontal (90°) with the tile.
- Apply light pressure and an oscillating circular motion during cutting to maximise tool life.
- When cutting material thicker than 10 mm, to optimise life and speed of cut, lift the drill/hole saw out of the hole every 5 seconds and allow it to rotate in the air to cool before continuing with the cut.



Description	Tool reception	Shank reception	Pack quantity	Min. order quantity	Article Number	EAN Code
② Adaptor to fit M14 diamond drills to Milwaukee spot polisher	M9 x 0.75	M14	1	1	4932472090	4058546324865
③ Adaptor to fit M14 diamond drills to Milwaukee die grinder	M16 x 1.0	M14	1	1	4932472265	4058546339111

DIAMOND PLUS™ 1/4" WET / DRY drill bits

Diamond grit edge drills and holesaws have been specially developed for professionals that need to drill in extremely hard materials such as porcelain/gres/quarry tiles, cast iron or fibreglass where it is increasingly difficult to drill with conventional holesaws. These holesaws guarantee excellent performance and superior life time even in the hardest of materials.

Water starved: These holesaws only require limited water supply unlike conventional diamond drills that require a continuous flow of water. Just dip the drill bit or holesaw into water at the start of each hole to be cut and thereafter every 5 second cut duration.

Clean holes: Drills clean, precise holes without any perimeter scratches.

Lifetime: To ensure long lifetime, we use high grade diamond for fast cutting and a superior brazed bond matrix to give best durability.

Durability: Tough alloy body which does not bend or distort easily.

Easy slug ejection: Offset slug ejection slots for greater leverage when removing tight slugs.

Versatile: Can be used either on angle grinders with relevant adaptor or with a drill.



Diameter (mm)	Reception	Pack quantity	Min. order quantity	Article Number	EAN Code
5	1/4" Hex	1	1	49560503	045242223732
6	1/4" Hex	1	1	49560505	045242223749
8	1/4" Hex	1	1	49560507	045242223756
10	1/4" Hex	1	1	49560509	045242223763
12	1/4" Hex	1	1	49560511	045242223770
15	1/4" Hex	1	1	49560513	045242223787
20	1/4" Hex	1	1	49560515	045242223794
25	1/4" Hex	1	1	49560517	045242223800

① **DIAMOND PLUS™ diamond drill bit set (3pc)**
 0 6, 8, 10 mm

Application areas

Ceramic tiles – all types hard and soft:
 Porcelain / Gres / Granite / Quarry / Terrazzo / Artificial stone / Terracota / Agglomerate / Glazed

Cast iron

Fibreglass / GRP
 (Glass reinforced plastic) / Perspex



Diameter (mm)	Reception	Pack quantity	Min. order quantity	Article Number	EAN Code
22	1/2" x 20	1	1	49565605	045242308439
29	1/2" x 20	1	1	49565615	045242308446
32	5/8" x 18	1	1	49565620	045242308453
35	5/8" x 18	1	1	49565625	045242308460
38	5/8" x 18	1	1	49565630	045242308477
44	5/8" x 18	1	1	49565640	045242308491
51	5/8" x 18	1	1	49565645	045242308507
68	5/8" x 18	1	1	49565664	045242337835

Description	Fits holesaw Ø	Shank reception	Holesaw or core reception	Pack quantity	Min. order quantity	Article Number	EAN Code
Arbor	Ø 14-30 mm	9.5 mm Hex	1/2" x 20	1	1	49567010	045242200177
Arbor	Ø 32-210 mm	9.5 mm Hex	5/8" x 18	1	1	49567250	045242225798
Grinder adaptor	Ø 22-29mm	M14	1/2" x 20	1	1	4932430464	4002395381258
Grinder adaptor	Ø 32-68mm	M14	5/8" x 18	1	1	4932430465	4002395381265

How to use on an angle grinder:

1. Screw the grinder adaptor M14 to the holesaw and tighten firmly with a spanner. Then apply the spindle lock on the angle grinder and fit the adaptor directly onto the spindle; tighten firmly with a spanner.
2. If the tile is not fitted to a wall or floor ensure it is secured firmly with a clamp.
3. Dip the holesaw tips into water.
4. Switch on angle grinder to full speed. Slowly approach the tile with the holesaw at a 20-30° angle with light pressure to avoid skating on the tile. Once the holesaw starts to cut into the tile and forms a groove, gradually raise the holesaw so that it is horizontal with the tile.
5. Every 5 seconds dip the holesaw in water.
6. Apply light pressure and an oscillating circular motion during cutting to maximise tool life.

Holesaw drilling guide

Drilling guide provides a secure drilling into the material without slipping around and damaging the surface.

Description	Pack quantity	Min. order quantity	Article Number	EAN Code
Drilling guide for drills / holesaws Ø 19 - 68 mm	1	1	4932352332	4002395369911

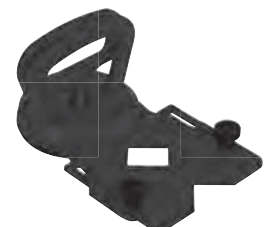

Wet Diamond Drilling Cores

- ① Standard 1/2" G reception
- ② Standard 1 1/4" UNC reception
- ③ Engraving of diameter and type on the core reception for longterm visibility
- ④ Laser welded segments guarantee against break off
- ④ 10 mm segment height for superior lifetime



THIN KERF Wet diamond drilling cores

Cordless optimised diamond segments designed especially for MXFuel tool.
 Optimised for corded diamond drills up to 2200 Watt.
 10 mm laser welded segments for superior lifetime.
 Standard 1/2" G reception on smaller diameters & standard 1 1/4" UNC reception on bigger diameters.



Diameter (mm)	Description	Fits DD3 - 152	Fits MXF DCD 150	Core reception	Working length (mm) B	Total length (mm) A	Pack quantity	Min. order quantity	Article Number	EAN Code
12	WCHP-TK 12 mm	✓	✓	1/2" G	200	270	1	1	4932472167	4058546325633
14	WCHP-TK 14 mm	✓	✓	1/2" G	300	370	1	1	4932472168	4058546325640
16	WCHP-TK 16 mm	✓	✓	1/2" G	300	370	1	1	4932472169	4058546325657
18	WCHP-TK 18 mm	✓	✓	1/2" G	300	370	1	1	4932472170	4058546325664
20	WCHP-TK 20 mm	✓	✓	1/2" G	300	370	1	1	4932472171	4058546325671
22	WCHP-TK 22 mm	✓	✓	1/2" G	300	370	1	1	4932472172	4058546325688
24	WCHP-TK 24 mm	✓	✓	1/2" G	300	370	1	1	4932472173	4058546325695
25	WCHP-TK 25 mm	✓	✓	1/2" G	300	370	1	1	4932472174	4058546325701
28	WCHP-TK 28 mm	✓	✓	1/2" G	300	370	1	1	4932472175	4058546325718
30	WCHP-TK 30 mm	✓	✓	1/2" G	300	370	1	1	4932472176	4058546325725
32	WCHP-TK 32 mm	✓	✓	1/2" G	300	370	1	1	4932472177	4058546325732
35	WCHP-TK 35 mm	✓	✓	1/2" G	300	370	1	1	4932472178	4058546325749
40	WCHP-TK 40 mm	✓	✓	1/2" G	300	370	1	1	4932472180	4058546325763
46	WCHP-TK 46 mm	✓	✓	1 1/4" UNC	450	525	1	1	4932478953	4058546362355
51	WCHP-TK 51 mm	✓	✓	1 1/4" UNC	450	525	1	1	4932472184	4058546325800
56	WCHP-TK 56 mm	✓	✓	1 1/4" UNC	450	525	1	1	4932472185	4058546325817
61	WCHP-TK 61 mm	✓	✓	1 1/4" UNC	450	525	1	1	4932472186	4058546325824
66	WCHP-TK 66 mm	✓	✓	1 1/4" UNC	450	525	1	1	4932472187	4058546325831
68	WCHP-TK 68 mm	✓	✓	1 1/4" UNC	450	525	1	1	4932478954	4058546362362
71	WCHP-TK 71 mm	✓	✓	1 1/4" UNC	450	525	1	1	4932472188	4058546325848
76	WCHP-TK 76 mm	✓	✓	1 1/4" UNC	450	525	1	1	4932472189	4058546325855
81	WCHP-TK 81 mm	✓	✓	1 1/4" UNC	450	525	1	1	4932472190	4058546325862
86	WCHP-TK 86 mm	✓	✓	1 1/4" UNC	450	525	1	1	4932472191	4058546325879
91	WCHP-TK 91 mm	✓	✓	1 1/4" UNC	450	525	1	1	4932472192	4058546325886
101	WCHP-TK 101 mm	✓	✓	1 1/4" UNC	450	525	1	1	4932472193	4058546325893
105	WCHP-TK 105 mm	✓	✓	1 1/4" UNC	450	525	1	1	4932472194	4058546325909
111	WCHP-TK 111 mm	✓	✓	1 1/4" UNC	450	525	1	1	4932472195	4058546325916
121	WCHP-TK 121 mm	✓	✓	1 1/4" UNC	450	525	1	1	4932472196	4058546325923
126	WCHP-TK 126 mm	✓	✓	1 1/4" UNC	450	525	1	1	4932478955	4058546362379
130	WCHP-TK 130 mm	✓	✓	1 1/4" UNC	450	525	1	1	4932472197	4058546325930
140	WCHP-TK 140 mm	✓	✓	1 1/4" UNC	450	525	1	1	4932472198	4058546325947
150	WCHP-TK 150 mm	✓	✓	1 1/4" UNC	450	525	1	1	4932472199	4058546325954



Wet diamond drilling cores

Diameter (mm)	Description	Fits DD3-152	Fits DCM2-250C & DCM2-350C	Core reception	Working length (mm) B	Total length (mm) A	Pack quantity	Min. order quantity	Article Number	EAN Code
52	WCHP 52	✓	✓	1 ¼" UNC	450	525	1	1	4932399707	4002395363582
62	WCHP 62	✓	✓	1 ¼" UNC	450	525	1	1	4932399708	4002395363599
72	WCHP 72	✓	✓	1 ¼" UNC	450	525	1	1	4932399709	4002395363605
82	WCHP 82	✓	✓	1 ¼" UNC	450	525	1	1	4932399710	4002395363612
92	WCHP 92	✓	✓	1 ¼" UNC	450	525	1	1	4932399711	4002395363629
102	WCHP 102	✓	✓	1 ¼" UNC	450	525	1	1	4932399712	4002395363636
112	WCHP 112	✓	✓	1 ¼" UNC	450	525	1	1	4932399713	4002395363643
122	WCHP 122	✓	✓	1 ¼" UNC	450	525	1	1	4932399714	4002395363650
132	WCHP 132	✓	✓	1 ¼" UNC	450	525	1	1	4932399715	4002395363667
152	WCHP 152	✓	✓	1 ¼" UNC	450	525	1	1	4932399716	4002395363674
162	WCHP 162	✓	✓	1 ¼" UNC	450	525	1	1	4932399717	4002395363681
172	WCHP 172	✓	✓	1 ¼" UNC	450	525	1	1	4932352052	4002395367092
182	WCHP 182	✓	✓	1 ¼" UNC	450	525	1	1	4932399718	4002395363698
202	WCHP 202	✓	✓	1 ¼" UNC	450	525	1	1	4932399719	4002395363704
225	WCHP 225	✓	✓	1 ¼" UNC	450	525	1	1	4932399720	4002395363711
250	WCHP 250	✓	✓	1 ¼" UNC	450	525	1	1	4932399721	4002395363728
300	WCHP 300	✓	✓	1 ¼" UNC	450	525	1	1	4932399722	4002395363735
350	WCHP 350	✓	✓	1 ¼" UNC	450	525	1	1	4932399723	4002395363742

✓ Most suitable

◆ Limited suitability

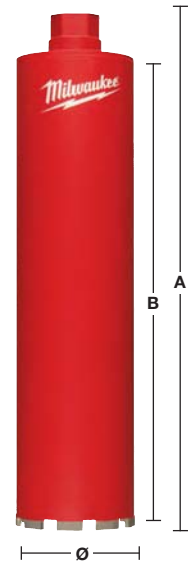

System attachments - Wet diamond drilling

Description	Fits DD3-152	Fits DCM2-250C & DCM2-DCD 150 350C	Fits MXF	Pack quantity	Min. order quantity	Article Number	EAN Code
Fixing kit. For exclusive use in concrete. Ø 16 mm drill bit is required to set the drop anchor				9	1	4932399731	4002395363827
① Stud bolt, setting tool, wing nut, washer and 5 pcs M12 drop anchor	✓	✓	✓	9	1	4932399731	4002395363827
1 3/8" open ended spanner. For holding the motor output spindle while removing a core bit		✓		1	1	49964705	04524222766
32 mm ended spanner. For holding the motor output spindle while removing a core bit.	✓			1	1	4931428009	4002395844791
41 mm open ended spanner. For removing the core bit from the motor spindle.	✓	✓		1	1	4931428010	4002395844807
Fixtec release. Suitable for all diamond motors with 1 1/4" spindle reception. Prevents the core bit from locking itself too tight onto the machine spindle. The core bits can then be released and removed with minimum effort	✓	✓		1	1	4932352053	4002395367108
② 1 1/4" female to 1/2" female adaptor. To enable the connection of <50 mm diamond core bits on a 1 1/4" machine spindle thread	✓	✓		1	1	4932352627	4002395372850
1 1/4" female / male extension rod, length 300 mm	✓	✓	✓	1	1	4932399724	4002395363759
③ 1 1/4" female / male extension rod, length 500 mm	✓	✓	✓	1	1	4932399725	4002395363766
Telescopic extension. Extension pole used to fix drill rig to the ground instead of anchor bolts. Maximum load of 500 kg and adjustable extension height from 1.8-2.9 m	✓	✓	✓	1	1	4932399732	4002395363834
④							
Vacuum pump VP6: For fastening of the diamond drill rig on smooth and even surfaces. Suction capacity: 850 mbar. Max. vacuum pressure: 6 m³/h / 100 l/min. Rated voltage: 220-240 V	✓	✓	✓	1	1	4932352094	4002395367474
⑤							
Vacuum plate. Replacement rubber seal 4931428665	✓			1	1	4932352676	4002395373345
⑥							
WT 10 watertank. 10 liters capacity, steel, water tank with inside and outside polyester coating. Reliable brass pump with a max. pressure bar of 6 bar. 2.5 m hose with quick connection system fits direct to Milwaukee® diamond drills	✓	✓	✓	1	1	4932399726	4002395363773
⑦							
Water collection ring: For use with drill rig DR 152 T. For use with max. Ø 152 mm core bits				1	1	4932352677	4002395373352
⑧ Replacement rubber ring for DR 152 T				1	1	4932352678	4002395373369
Water collection ring: For use with drill rig DR 250 TV. For use with max. Ø 180 mm core bits			✓	1	1	4932399727	4002395363780
⑨ Replacement rubber ring for DR 250 TV			✓	1	1	4932399729	4002395363803
Water collection ring: For use with drill rig DR 350 T. For use with max. Ø 300 mm core bits				1	1	4932399728	4002395363797
⑨ Replacement rubber ring for DR 350 T				1	1	4932399730	4002395363810
Spacer block T = 50 mm. Needs to be mouted between drill rig and motor cores > 250 mm and max. 350 mm. Included in drill rig DR 350 T		✓		1	1	4932399736	4002395363872
⑩							
Quick connection motor mounting plate. Included in both drill rigs DR 250 TV and DR 350 T		✓		1	1	4932399733	4002395363841
⑪							
Water collection ring: For universal use with diamond drilling tools. For use with max. Ø 152 mm core bits	✓	✓	✓	1	1	4932478073	4058546340063
⑫							



FIXTEC Diamond Core System

The patented MILWAUKEE® range of FIXTEC diamond core adaptors allows changing diamond cores in a matter of seconds without the use of extra tools.

The most common complaint with existing systems is that the diamond core locks itself tight onto the machine making it increasingly difficult to later remove the core, even with the aid of spanners and wrenches. However with the new FIXTEC adaptor solution from MILWAUKEE® this is a problem of the past, the cores can be unscrewed, removed and exchanged quite simply by hand – there is no need for spanners or wrenches.

The revolutionary FIXTEC adaptors are available with or without dust absorption and with different tool receptions making them compatible to other manufacturers tools.

The Past



The Future



FIXTEC solution

FIXTEC solution with dust extraction

FIXTEC Clean Liner Rotor (CLR) fits to diamond cores with 1 1/4" UNC thread. The added advantage of dust absorption allows drilling speed to be increased and extends the lifetime of the diamond cores.

Description	Tool reception	Core reception	Pack quantity	Min. order quantity	Article Number	EAN Code
② FIXTEC Clean Line Rotor (CLR)	M18 x 2.5	1 1/4" UNC	1	1	4932352172	4002395368242



FIXTEC solution without dust extraction

FIXTEC adaptor fits to diamond cores with M16 thread. As centering drill bit a standard SDS-plus drill bit can be used.

Description	Tool reception	Core reception	Pack quantity	Min. order quantity	Article Number	EAN Code
FIXTEC adaptor. Tool changing in seconds. No extra tool required	M18 x 2.5	M16	1	1	4932399174	4002395357819
	11 mm Hex	M16	1	1	4932399220	4002395358342



Dry diamond cores with dust extraction - DCHXL

10 mm high segments for longer life.

Laser welded segments for extra durability.

Use with the machine set to rotary only, not suitable for hammer action.

During pre-drilling the centering unit (centering stars, guide rod and SDS Plus pilot drill bit) must be used.



Material	DCHXL	Material	DCHXL
Aerated/breeze concrete blocks	◆	Granite	✘
Artificial stone – hard	✘	Lime/sandstone – hard	✓
Brick – very hard, engineering brick	✓	Lime/sandstone – soft/abrasive	◆
Brick – medium	✓	Marble	✘
Brick – soft	◆	Tiles	✘
Concrete	✘		

✓ Most suitable. Recommended for these materials.

✘ Not suitable. Not recommended for these materials.

◆ Limited suitability – recommended for intermittent use.

Very good in drilling characteristics, but reduced lifetime.

Description	Diameter (mm)	Core reception	Working length (mm) B	Total length (mm) A	Pack quantity	Min. order quantity	Article Number	EAN Code
DCHXL 38*	38	1 1/4" UNC	420	490	1	1	4932399753	4002395364060
DCHXL 52	52	1 1/4" UNC	420	490	1	1	4932399163	4002395357703
DCHXL 68	68	1 1/4" UNC	420	490	1	1	4932399164	4002395357710
DCHXL 82	82	1 1/4" UNC	420	490	1	1	4932399165	4002395357727
DCHXL 102	102	1 1/4" UNC	420	490	1	1	4932399166	4002395357734
DCHXL 107	107	1 1/4" UNC	420	490	1	1	4932399754	4002395364077
① DCHXL 112	112	1 1/4" UNC	420	490	1	1	4932399167	4002395357741
DCHXL 117	117	1 1/4" UNC	420	490	1	1	4932399755	4002395364084
DCHXL 122	122	1 1/4" UNC	420	490	1	1	4932399168	4002395357758
DCHXL 127	127	1 1/4" UNC	420	490	1	1	4932399169	4002395357765
DCHXL 132	132	1 1/4" UNC	420	490	1	1	4932399170	4002395357772
DCHXL 152	152	1 1/4" UNC	420	490	1	1	4932399171	4002395357789
DCHXL 162	162	1 1/4" UNC	420	490	1	1	4932399172	4002395357796

* During pre-drilling no centering star required.

Description	Tool reception	Core reception	Pack quantity	Min. order quantity	Article Number	EAN Code
② FIXTEC Clean Line Rotor (CLR)	M18 x 2.5	1 1/4" UNC	1	1	4932352172	4002395368242

Description	Pack quantity	Min. order quantity	Article Number	EAN Code
③ Guide rod for DD2-160. Supplied with locking screw (4931622432). Requires allen key (4931616044) and SDS-plus pilot drill bit (Ø 8 x 160 mm, 4932307071)	1	1	4932399173	4002395357802
④ Guide rod for DD3-152. Requires SDS-plus pilot drill bit (Ø 8 x 110 mm, 4932307070)	1	1	4932352679	4002395373376

Diameter (mm)	Article Number	EAN Code	Diameter (mm)	Article Number	EAN Code
52	4931393176	4002395358380	117	4931403508	4002395364107
68	4931393177	4002395358397	122	4931393181	4002395780709
82	4931393178	4002395358403	127	4931393182	4002395780716
⑤ 102	4931393179	4002395358410	132	4931393183	4002395358458
107	4931403507	4002395364091	152	4931393184	4002395358465
112	4931393180	4002395358427	162	4931393185	4002395358472

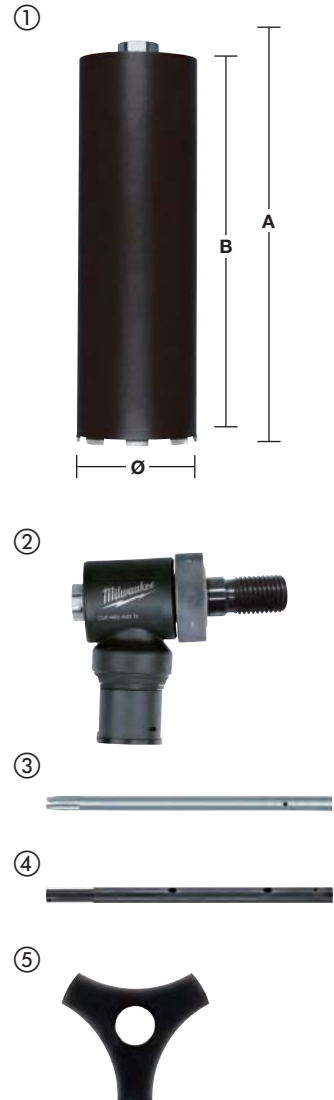

Dry diamond cores for electrical sockets with dust extraction - DCHX

- 10 mm high segments for longer life.
- Laser welded segments for extra durability.
- Suitable for installation of electrical sockets and junction boxes.
- Use with the machine set to rotary only, not suitable for hammer action.

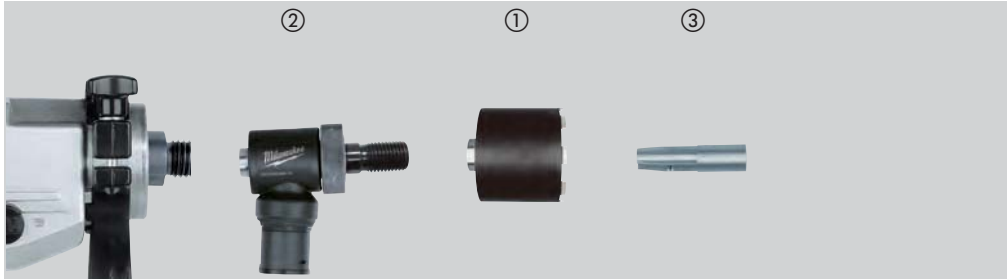

Material	DCHX	Material	DCHX
Aerated/breeze concrete blocks	◆	Granite	✘
Artificial stone – hard	✘	Lime/sandstone – hard	✓
Brick – very hard, engineering brick	✓	Lime/sandstone – soft/abrasive	◆
Brick – medium	✓	Marble	✘
Brick – soft	◆	Tiles	✘
Concrete	✘		

- ✓ Most suitable. Recommended for these materials.
- ◆ Limited suitability – recommended for intermittent use. Very good in drilling characteristics, but reduced lifetime.
- ✘ Not suitable. Not recommended for these materials.

Description	Diameter (mm)	Core reception	Working length (mm) B	Total length (mm) A	Pack quantity	Min. order quantity	Article Number	EAN Code
① DCHX 68	68	1 ¼" UNC	60	130	1	1	4932399217	4002395358311
DCHX 82	82	1 ¼" UNC	60	130	1	1	4932399218	4002395358328

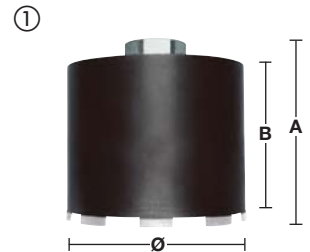

Description	Tool reception	Core reception	Pack quantity	Min. order quantity	Article Number	EAN Code
② FIXTEC Clean Line Rotor (CLR)	M18 x 2.5	1 ¼" UNC	1	1	4932352172	4002395368242



Description	Pack quantity	Min. order quantity	Article Number	EAN Code
③ Guide rod for DD2-160 Supplied with locking screw (4931622432). Requires allen key (4931616044) and SDS-plus pilot drill bit (8 x 110 mm, 4932307070)	1	1	4932399221	4002395358359
Guide rod for DD3-152. Requires SDS-plus pilot drill bit (8 x 110 mm, 4932307070)	1	1	4932352680	4002395373383



Dry diamond drilling for electrical sockets without dust extraction - DCU / DCH

7 mm high segments.
 Laser welded segments for extra durability.
 Suitable for installation of electrical sockets and junction boxes.
 Use with the machine set to rotary only, not suitable for hammer action.

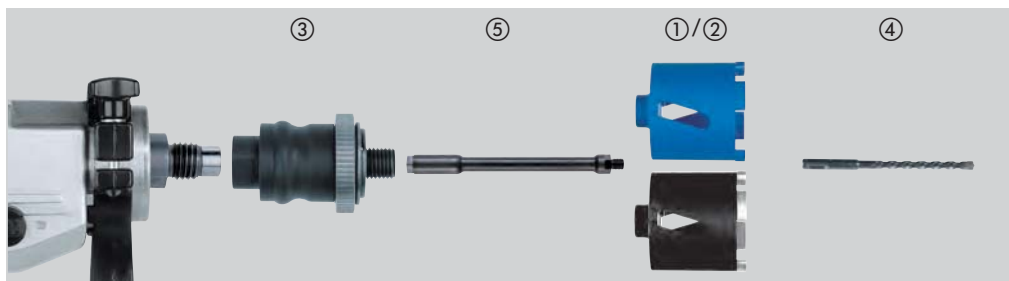

Material	DCU	DCH	Material	DCU	DCH
Aerated/breeze concrete blocks	◆	◆	Granite	✗	✗
Artificial stone – hard	✗	✗	Lime/sandstone – hard	◆	✓
Brick – very hard, engineering brick	◆	✓	Lime/sandstone – soft/abrasive	✓	◆
Brick – medium	✓	✓	Marble	✗	✗
Brick – soft	✓	◆	Tiles	✗	✗
Concrete	✗	✗			

- ✓ Most suitable. Recommended for these materials.
- ◆ Limited suitability – recommended for intermittent use. Very good in drilling characteristics, but reduced lifetime.
- ✗ Not suitable. Not recommended for these materials.

- ✓ Most suitable. Recommended for these materials.
- ◆ Limited suitability – recommended for intermittent use. Very good in drilling characteristics, but reduced lifetime.
- ✗ Not suitable. Not recommended for these materials.

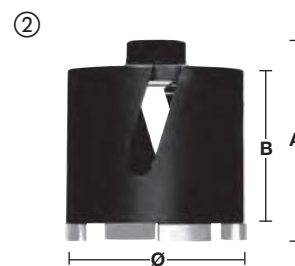
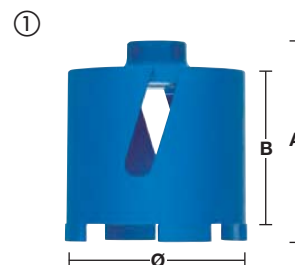

Description	Diameter (mm)	Core reception	Working length (mm) B	Total length (mm) A	Pack quantity	Min. order quantity	Article Number	EAN Code
① DCU 68	68	M16	60	90	1	1	4932371978	4002395346035
① DCU 82	82	M16	60	90	1	1	4932371979	4002395346042
② DCH 68	68	M16	60	90	1	1	4932399579	4002395362080
② DCH 82	82	M16	60	90	1	1	4932399580	4002395362097

Description	Tool reception	Core reception	Pack quantity	Min. order quantity	Article Number	EAN Code
③ FIXTEC adaptor. Tool changing in seconds. No extra tool required	M18 x 2.5	M16	1	1	4932399174	4002395357819
	11 mm Hex	M16	1	1	4932399220	4002395358342
④ Requires SDS-plus pilot drill bit (Ø 8 x 160 mm)			1	1	4932307071	4002395308873



Description	Adaptor reception	Core reception	Total length (mm) A	Pack quantity	Min. order quantity	Article Number	EAN Code
⑤ Extension between FIXTEC adaptor and diamond core	M16	M16	300	1	1	4932369736	4002395346028



Dry diamond drilling without dust extraction - DCH 150

10 mm high segments.

Laser welded segments for extra durability.

Use with the machine set to rotary only, not suitable for hammer action.

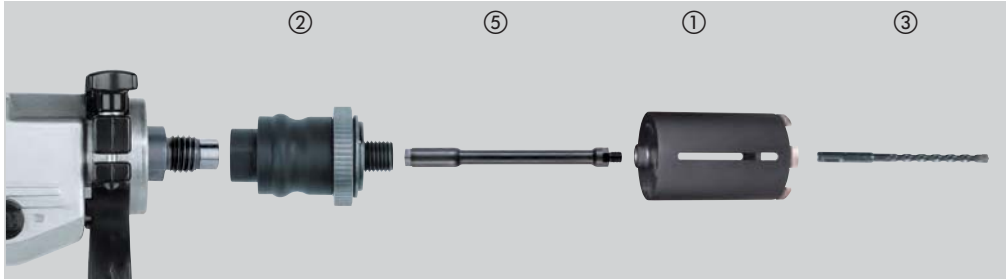

Material	DCH	Material	DCH
Aerated/breeze concrete blocks	◆	Granite	✘
Artificial stone – hard	✘	Lime/sandstone – hard	✓
Brick – very hard, engineering brick	✓	Lime/sandstone – soft/abrasive	◆
Brick – medium	✓	Marble	✘
Brick – soft	◆	Tiles	✘
Concrete	✘		

- ✓ Most suitable. Recommended for these materials.
- ◆ Limited suitability – recommended for intermittent use. Very good in drilling characteristics, but reduced lifetime.
- ✘ Not suitable. Not recommended for these materials.

- ✓ Most suitable. Recommended for these materials.
- ◆ Limited suitability – recommended for intermittent use. Very good in drilling characteristics, but reduced lifetime.
- ✘ Not suitable. Not recommended for these materials.

Description	Diameter (mm)	Core reception	Working length (mm) B	Total length (mm) A	Pack quantity	Min. order quantity	Article Number	EAN Code
DCH 150-52	52	M16	150	180	1	1	4932352628	4002395372867
DCH 150-62	62	M16	150	180	1	1	4932352629	4002395372874
DCH 150-68	68	M16	150	180	1	1	4932352630	4002395372881
DCH 150-82	82	M16	150	180	1	1	4932352631	4002395372898
DCH 150-102	102	M16	150	180	1	1	4932352632	4002395372904
DCH 150-127	127	M16	150	180	1	1	4932352633	4002395372911

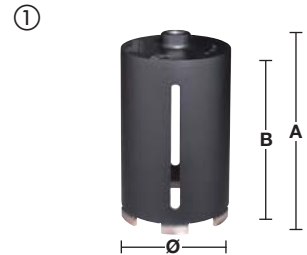

Description	Tool reception	Core reception	Pack quantity	Min. order quantity	Article Number	EAN Code
② FIXTEC adaptor. Tool changing in seconds. No extra tool required	M18 x 2.5	M16	1	1	4932399174	4002395357819
	11 mm Hex	M16	1	1	4932399220	4002395358342
③ Requires SDS-plus pilot drill bit (Ø 8 x 260 mm)			1	1	4932353821	4002395320141



Description	Adaptor reception	Core reception	Total length (mm) A	Pack quantity	Min. order quantity	Article Number	EAN Code
④ Extension between FIXTEC adaptor and diamond core	M16	M16	300	1	1	4932369736	4002395346028

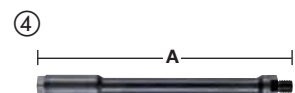

SHOCKWAVE 
IMPACT DUTY

DRIVING PERFORMANCE FORWARD

FASTENING

NEXT GENERATION
SHOCKWAVE™ IMPACT DRIVER BITS

TiD-extra
Industrial Technology d.o.o.



**WEAR
GUARD
TIP™**



**CUSTOM
ALLOY 76™
STEEL**



**OPTIMIZED
SHOCK ZONE™**

MILWAUKEE® SHOCKWAVE™ IMPACT DUTY driver bits are engineered to be the most durable, best fitting driver bits on the market. The WEAR GUARD TIP™ is laser hardened to create an outer shield that protects the fit over the life of the bit. The SHOCK ZONE™ is optimized for each tip type and length of driver bit, absorbing peak torque and preventing breaking. The customized CUSTOM ALLOY 76™ steel and heat treatment for each tip type is engineered to ensure best performance across tip types and extended life vs. standard bits. The SHOCKWAVE™ impact driver bits provide extreme durability for the most demanding job site applications.



SHOCKWAVE™ IMPACT DUTY screwdriving bits

IMPACT

Designed for use with impact drivers the SHOCKWAVE™ IMPACT DUTY accessory line is not only ideal for heavy duty impact applications, but also delivers a full system solution for all the user's drilling and fastening needs.

Laser hardened WEAR GUARD TIP™ for improved wear resistance and protection of the fit over the life of the bit.

SHOCK ZONE™ Geometry - designed to flex:

SHOCK ZONE™ reduces stress at the tip resulting in less tip breakages. The combination of the SHOCK ZONE™ design and special heat treatment absorbs impacts and allows the bit to flex with spring like action.

Custom engineered steel - MILWAUKEE® custom metal formula makes the SHOCKWAVE™ bits more resistant to shock from impacting.



- A) 25 mm 1/4" Hex - DIN 3126 - C 6.3
- B) 50 mm 1/4" Hex - DIN 3126 - E 6.3
- C) 90 mm 1/4" Hex - DIN 3126 - E 6.3
- D) 150 mm 1/4" Hex - DIN 3126 - E 6.3

TiD-extra
Industrial Technologies d.o.o.

Type	Total length (mm)	Supplied in	Pack quantity	Min. order quantity	Article Number	EAN Code	
Philips 	PH 1	25	①	2	1	4932430850	4002395385126
		50	①	1	1	4932471564	4058546294632
		90	①	1	1	4932430851	4002395385133
	PH 2	25	①	2	1	4932430852	4002395385140
		25	②	25	10	4932430853	4002395385157
		50	①	1	1	4932430854	4002395385164
		50	②	10	10	4932430855	4002395385171
		90	①	1	1	4932430856	4002395385188
		150	①	1	1	4932471565	4058546294649
	PH 3	25	①	2	1	4932430857	4002395385195
		50	①	1	1	4932430858	4002395385201
		90	①	1	1	4932430859	4002395385218
PoziDrive 	PZ 1	25	①	2	1	4932430860	4002395385225
		25	②	25	10	4932430861	4002395385232
		50	①	1	1	4932471566	4058546294656
		90	①	1	1	4932430862	4002395385249
	PZ 2	25	①	2	1	4932430863	4002395385256
		25	②	25	10	4932430864	4002395385263
		50	①	1	1	4932430865	4002395385270
		50	②	10	10	4932430866	4002395385287
		90	①	1	1	4932430867	4002395385294
	150	①	1	1	4932471928	4058546298272	
	PZ 3	25	①	2	1	4932430868	4002395385300
		25	②	25	10	4932430869	4002395385317
50		①	1	1	4932430870	4002395385324	
150		①	1	1	4932471929	4058546298289	

① Blister



② Storage container



Minimum order quantity = 10 pcs (come in counter display) orders. > 10 pcs must be ordered in multiples of 10 (i.e. 10,20,30)

③ Counter display



SHOCKWAVE TM

IMPACT DUTY



Type	Total length (mm)	Supplied in	Pack quantity	Min. order quantity	Article Number	EAN Code
TORX®	TX 7	①	2	1	4932471567	4058546294663
	TX 8	①	2	1	4932471568	4058546294670
	TX 9	①	2	1	4932471569	4058546294687
	TX 10	①	2	1	4932430871	4002395385331
		①	1	1	4932471570	4058546294694
	TX 15	①	2	1	4932430872	4002395385348
		②	25	10	4932430873	4002395385355
		①	1	1	4932451286	4002395157440
		①	1	1	4932471571	4058546294700
	150	①	1	1	4932471572	4058546294717
	TX 20	①	2	1	4932430874	4002395385362
		②	25	10	4932430875	4002395385379
		①	1	1	4932430876	4002395385386
		②	10	10	4932430877	4002395385393
		①	1	1	4932430878	4002395385409
	150	①	1	1	4932471573	4058546294724
	TX 25	①	2	1	4932430879	4002395385416
		②	25	10	4932430880	4002395385423
		①	1	1	4932430881	4002395385430
		②	10	10	4932430882	4002395385447
		①	1	1	4932430883	4002395385454
	TX 27	①	2	1	4932430884	4002395385461
	TX 30	①	2	1	4932430885	4002395385478
		②	25	10	4932430886	4002395385485
		①	1	1	4932430887	4002395385492
		②	10	10	4932471574	4058546294731
		①	1	1	4932471575	4058546294748
	TX 40	①	2	1	4932430888	4002395385508
		②	25	10	4932430889	4002395385515
		①	1	1	4932430890	4002395385522
	TX 50	①	2	1	4932430891	4002395385539
		②	15	10	4932430892	4002395385546

① Blister



② Storage container





Minimum order quantity = 10 pcs (come in counter display) orders. > 10 pcs must be ordered in multiples of 10 (i.e. 10,20,30)

③ Counter display



SHOCKWAVE TM

IMPACT DUTY

Type	Total length (mm)	Supplied in	Pack quantity	Min. order quantity	Article Number	EAN Code
TORX® B0						
 TX B07	25	①	2	1	4932471577	4058546294762
TX B08	25	①	2	1	4932471578	4058546294779
TX B09	25	①	2	1	4932471579	4058546294786
TX B010	25	①	2	1	4932471580	4058546294793
TX B015	25	①	2	1	4932471581	4058546294809
TX B020	25	①	2	1	4932471582	4058546294816
TX B025	25	①	2	1	4932471583	4058546294823
TX B030	25	①	2	1	4932471584	4058546294830
TX B040	25	①	2	1	4932471585	4058546294847
Hex						
 Hex 2.5 mm	25	①	2	1	4932430893	4002395385553
Hex 3 mm	25	①	2	1	4932430894	4002395385560
Hex 4 mm	25	①	2	1	4932430895	4002395385577
Hex 5 mm	25	①	2	1	4932430896	4002395385584
Hex 6 mm	25	①	2	1	4932430897	4002395385591
Hex 8 mm	25	①	2	1	4932430898	4002395385607
Hex 10 mm	25	①	2	1	4932430899	4002395385614
Hex 12 mm	25	①	2	1	4932430900	4002395385621
Slotted						
 SL 0.6 x 4.5	25	①	2	1	4932430901	4002395385638
SL 0.8 x 5.5	25	①	2	1	4932430902	4002395385645
SL 1.2 x 6.5	25	①	2	1	4932430903	4002395385652

① Blister



SHOCKWAVE™ IMPACT DUTY ™

SHOCKWAVE™ IMPACT DUTY sets

Description	Pack quantity	Min. order quantity	Article Number	EAN Code
<p>SHOCKWAVE™ IMPACT DUTY puck bit set (15 pc)</p> <p>SHOCKWAVE™ screwdriving bits: 14 x 25 mm length: ① 1 x PH1 / 2 x PH2, 1 x PZ1 / 2 x PZ2 / 1 x PZ3, 1 x TX10 / 2 x TX15 / 2 x TX20 / 1 x TX25 / 1 x TX30, 1 x SHOCKWAVE™ magnetic bit holder 60 mm length</p>	15	10	4932430904	4002395385669
<p>SHOCKWAVE™ IMPACT DUTY bit set (32 pc)</p> <p>SHOCKWAVE™ screwdriving bits: 31 x 25 mm length: ② 1 x PH1 / 2 x PH2 / 1 x PH3, 1 x PZ1 / 2 x PZ2 / 1 x PZ3, 2 x TX10 / 2 x TX15 / 3 x TX20 / 2 x TX25 / 2 x TX30 / 1 x TX40, 1 x TX B07 / 1 x TX B08 / 1 x TX B09 / 1 x TX B010 / 1 x TX B015 / 1 x TX B020 / 1 x TX B025, 1 x Hex 3 mm / 1 x Hex 4 mm / 1 x Hex 5 mm / 1 x Hex 6 mm, 1 x SHOCKWAVE™ locking bit holder 1/4" Hex reception 73 mm long</p>	32	12	4932464240	4058546221850
<p>SHOCKWAVE™ IMPACT DUTY TX bit set (32 pc)</p> <p>SHOCKWAVE™ TX screwdriving bits: 31 x 25 mm length: 2 x TX10 / 4 x TX15 / 5 x TX20 / 5 x TX25 / 5 x TX30 / 2 x TX40 / 1 x TX50, 1 x TX B07 / 1 x TX B08 / 1 x TX B09 / 1 x TX B010 / 1 x TX B015 / 1 x TX B020 / 1 x TX B025, 1 x SHOCKWAVE™ locking bit holder 1/4" Hex reception 73 mm long</p>	32	12	4932471586	4058546294854
<p>SHOCKWAVE™ IMPACT DUTY bit set (33 pc)</p> <p>SHOCKWAVE™ screwdriving bits: 24 x 25 mm length ④ 1 x PH1 / 2 x PH2 / 1 x PH3, 2 x PZ1 / 3 x PZ2 / 2 x PZ3, 2 x TX10 / 2 x TX15 / 3 x TX20 / 2 x TX25 / 2 x TX30 / 1 x TX40 / 1 x TX50, 5 x 50 mm length 1 x PH2 / 1 x PZ2, 1 x TX15 / 1 x TX20 / 1 x TX25, 3 x SHOCKWAVE™ magnetic nut drivers: 48 mm length 1 x Hex 7 mm / 1 x Hex 8 mm / 1 x Hex 10 mm, 1 x SHOCKWAVE™ magnetic bit holder 60 mm length</p>	33	6	4932430905	4002395385676
<p>SHOCKWAVE™ IMPACT DUTY bit set (40 pc)</p> <p>SHOCKWAVE™ screwdriving bits: 25 x 25 mm length ⑤ 1 x PH1 / 2 x PH2, 1 x PZ1 / 3 x PZ2, 2 x TX10 / 2 x TX15 / 3 x TX20 / 2 x TX25 / 2 x TX30 / 1 x TX40 / 1 x TX50, 1 x Hex 4 mm / 1 x Hex 5 mm, 1 x SL 0.6 x 4.5 / 1 x SL 0.8 x 5.5 / 1 x SL 1.2 x 6.5, 8 x 50 mm length 1 x PH2, 1 x PZ1 / 1 x PZ2, 1 x TX10 / 1 x TX15 / 1 x TX20 / 1 x TX25 / 1 x TX30, SHOCKWAVE™ magnetic bit holder: 1 x 60 mm length, 1 x 152 mm length, 3 x SHOCKWAVE™ 1/4" Hex drill bits: Ø 3 / 4 / 5 mm, 2 x SHOCKWAVE™ magnetic nut drivers: 48 mm length 1 x Hex 8 mm / 1 x Hex 10 mm</p>	40	6	4932430908	4002395385706

①



②



③



④



⑤



SHOCKWAVE™ IMPACT DUTY sets

Description	Pack quantity	Min. order quantity	Article Number	EAN Code
<p>SHOCKWAVE™ IMPACT DUTY bit set (48 pc)</p> <p>SHOCKWAVE™ screwdriving bits: 32 x 25 mm length 2 x PH1 / 2 x PH2 / 1 x PH3, 2 x PZ1 / 3 x PZ2 / 1 x PZ3, 3 x TX10 / 3 x TX15 / 3 x TX20 / 3 x TX25 / 3 x TX30 / 1 x TX40, 1 x Hex 4 mm / 1 x Hex 5 mm, 1 x SL 0.6 x 4.5 / 1 x SL 0.8 x 5.5 / 1 x SL 1.2 x 6.5. 8 x 50 mm length 1 x PH1 / 1 x PH2, 1 x PZ2, 1 x TX10 / 1 x TX15 / 1 x TX20 / 1 x TX25 / 1 x TX30. 3 x 90 mm length 1 x PZ2, 1 x TX20 / 1 x TX25. 1 x SHOCKWAVE™ magnetic bit holder 60 mm length. 4 x Shockwave 1/4" Hex drill bits: Ø 3 / 4 / 5 / 6 mm</p>	48	6	4932430906	4002395385683
<p>SHOCKWAVE™ IMPACT DUTY bit set (56 pc)</p> <p>SHOCKWAVE™ screwdriving bits: 48 x 25 mm length 2 x PH1 / 3 x PH2 / 1 x PH3, 3 x PZ1 / 4 x PZ2 / 2 x PZ3, 3 x TX10 / 3 x TX15 / 4 x TX20 / 4 x TX25 / 4 x TX30 / 3 x TX40 / 2 x TX50, 2 x Hex 4 mm / 2 x Hex 5 mm, 2 x SL 0.6 x 4.5 / 2 x SL 0.8 x 5.5 / 2 x SL 1.2 x 6.5. 7 x 50 mm length 1 x PH2, 1 x PZ1 / 1 x PZ2, 1 x TX10 / 1 x TX15 / 1 x TX20 / 1 x TX25. 1 x SHOCKWAVE™ magnetic bit holder 60 mm length</p>	56	6	4932430907	4002395385690
<p>SHOCKWAVE™ IMPACT DUTY XL PZ bit set (70 pc)</p> <p>SHOCKWAVE™ screwdriving bits: 55 x 25 mm length 1 x PH1 / 2 x PH2, 3 x PZ1 / 31 x PZ2 / 5 x PZ3, 1 x TX10 / 1 x TX15 / 2 x TX20 / 2 x TX25 / 2 x TX30 / 1 x TX40, 1 x Hex 3 mm / 1 x Hex 4 mm / 1 x Hex 5 mm / 1 x Hex 6 mm. 12 x 50 mm length 1 x PH1 / 1 x PH2, 1 x PZ1 / 4 x PZ2 / 1 x PZ3, 1 x TX15 / 1 x TX20 / 1 x TX25 / 1 x TX30. 2 x SHOCKWAVE™ nut drivers 48 mm length: Hex 8 mm / Hex 10 mm. 1 x SHOCKWAVE™ magnetic bit holder 60 mm length</p>	70	6	4932471587	4058546294861
<p>SHOCKWAVE™ IMPACT DUTY XL TX bit set (75 pc)</p> <p>SHOCKWAVE™ screwdriving bits: 60 x 25 mm length 1 x PH1 / 2 x PH2, 1 x PZ1 / 3 x PZ2 / 1 x PZ3, 2 x TX10 / 4 x TX15 / 12 x TX20 / 12 x TX25 / 12 x TX30 / 2 x TX40 / 1 x TX50, 1 x TX B07 / 1 x TX B08 / 1 x TX B09 / 1 x TX B010 / 1 x TX B015, 1 x Hex 4 mm / 1 x Hex 5 mm. 12 x 50 mm length 1 x PH2, 1 x PZ1 / 1 x PZ2, 1 x TX10 / 2 x TX15 / 2 x TX20 / 2 x TX25 / 2 x TX30. 2 x SHOCKWAVE™ nut drivers 48 mm length: Hex 8 mm / Hex 10 mm. 1 x SHOCKWAVE™ magnetic bit holder 60 mm length</p>	75	6	4932471588	4058546294878



SHOCKWAVE™ IMPACT DUTY

SHOCKWAVE™ Impact Duty drive guide cassettes

Slimline pocket design.
 Drive guide bit holder with extendable sleeve to hold long screws secure. Up to 110 mm total length.
 Front loading screwdriver handle.
 Metal wire stripper for Ø 0.75 / 1.0 / 1.5 / 2.5 mm².
 Wire loop maker up to 5 mm².



Description	Total length (mm)	Pack quantity	Min. order quantity	Article Number	EAN Code
SHOCKWAVE™ IMPACT DUTY drive guide set (12pc)					
1 x PH2, 1 x PZ1 / 2 x PZ2 / 1 x PZ3, 1 x TX15 / 1 x TX20 / 2 x TX25 / 1 x TX30 / 1 x TX40, 1 x drive guide bit holder 76 mm length	25	12	10	4932430910	4002395385720

FASTENING

SHOCKWAVE™ IMPACT DUTY magnetic bit holder

Custom engineered steel and heat treatment for maximum strength and flexibility.
 Optimised SHOCK ZONE™ absorbs up to 3X more torque for more resistance to shock from impacting.
 Strong magnetic tip for secure grip.
 1/4" Hex reception (DIN 3126 - E 6.3). Very suitable for high torque and impact applications.

Description	Total length (mm) A	Pack quantity	Min. order quantity	Article Number	EAN Code
① Magnetic bit holder 60 mm	60	1	1	4932352406	4002395370658
② Magnetic bit holder 60 mm - jam jar (100pc)	60	1	100	4932430478	4002395381395
③ Magnetic bit holder 152 mm - long series	152	1	1	4932471822	4058546297213
④ Magnetic bit holder 305 mm - long series	305	1	1	4932471823	4058546297220

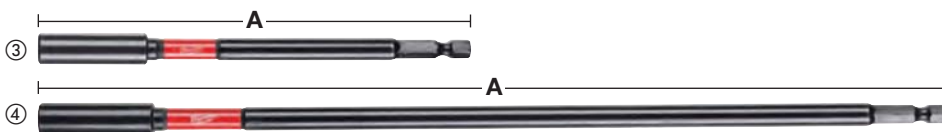
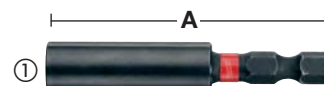

SHOCKWAVE™ IMPACT DUTY locking bit holder

Custom engineered steel - MILWAUKEE® custom metal formula makes the SHOCKWAVE™ bits more resistant to shock from impacting.

Optimised SHOCK ZONE™ absorbs up to 3X more torque.

Dual internal magnets ensure magnetism to fasteners.

Auto-Locking - One handed bit release.

1/4" Hex reception (DIN 3126 - E 6.3). Very suitable for high torque and impact applications.

Description	Total length (mm) A	Pack quantity	Min. order quantity	Article Number	EAN Code
① Locking bit holder 73 mm	73	1	1	4932459398	4058546010591
② Locking bit holder 152 mm - long series	152	1	1	4932471824	4058546297237
③ Locking bit holder 305 mm - long series	305	1	1	4932471825	4058546297244

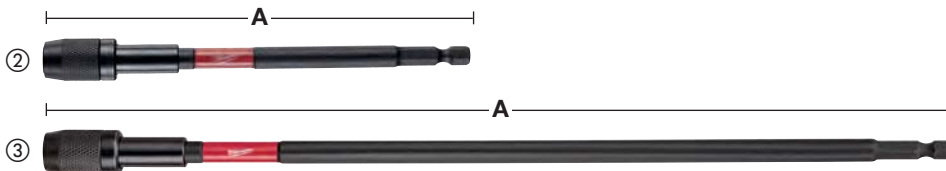

SHOCKWAVE™ IMPACT DUTY socket adaptors - Hex reception

Description	Total length (mm)	Pack quantity	Min. order quantity	Article Number	EAN Code
① Socket adaptor: 1/4" Hex - 1/4" square. DIN 3126 - E 6.3	50	1	1	4932471826	4058546297251
② Socket adaptor: 1/4" Hex - 3/8" square. DIN 3126 - E 6.3	50	1	1	4932478054	4058546339876
③ Socket adaptor: 1/4" Hex - 1/2" square. DIN 3126 - E 6.3	50	1	1	4932471827	4058546297268



SHOCKWAVE™ IMPACT DUTY magnetic nut drivers

Custom engineered steel and heat treatment for maximum strength and extreme durability.

Strong magnetic tip for secure grip.

1/4" Hex reception (DIN 3126 - E 6.3). Very suitable for high torque and impact applications.

Size AF (across flats) (mm)	For anchor thread size	Total length (mm) A	Pack quantity	Min. order quantity	Article Number	EAN Code
5.5	M3	65	1	1	4932352536	4002395371945
6.0	M3.5	65	1	1	4932352537	4002395371952
1/4"	-	65	1	1	4932352538	4002395371969
7.0	M4	65	1	1	4932352539	4002395371976
5/16"	-	65	1	1	4932352540	4002395371983
8.0	M5	65	1	1	4932352541	4002395371990
3/8"	-	65	1	1	4932352542	4002395372003
10.0	M6	65	1	1	4932352543	4002395372010
12.0	M7	65	1	1	4932352544	4002395372027
13.0	M8	65	1	1	4932352545	4002395372034
17.0	M10	65	1	1	4932352546	4002395372041
SHOCKWAVE™ IMPACT DUTY magnetic nut driver set (5pc)			5	1	4932352822	4002395374809
Ø 7 / 8 / 10 / 12 / 13 mm						



SHOCKWAVE™ **IMPACT DUTY**

SHOCKWAVE™ right angle attachment

The right angle attachment is a useful device for screwdriving or drilling applications in restricted, difficult to reach areas.

Impact rated: suitable to use with latest 18V impact drivers as well as cordless drill drivers.

Internal SHOCK ZONE™ and advanced gear design for excellent power transmission and impact durability.

For all 1/4" Hex driving and drilling accessories.

Very compact design: only 36 mm in height and a true 90° angle to allow access into confined spaces.

Ergonomic rubber overmold for secure and comfortable handling.

Pack contains 1 x right angle attachment and 10 x 25 mm screwdriving bits.

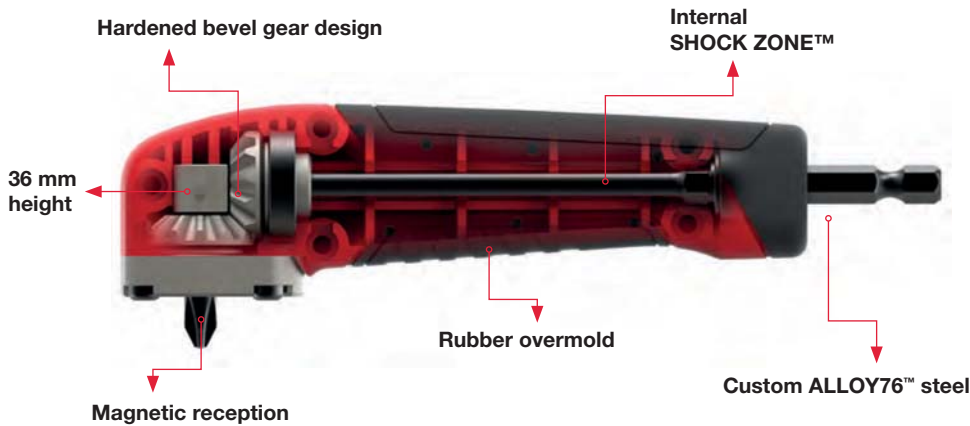

Description	Pack quantity	Min. order quantity	Article Number	EAN Code
Counter display SHOCKWAVE™ Right Angle Attachment set (11pc)	11	12	4932471274	4058546289027
1 x Right Angle Attachment, 1 x PH2, 1 x PZ1 / 2 x PZ2 / 1 x PZ3, 1 x TX10 / 1 x TX15 / 1 x TX20 / 1 x TX25 / 1 x TX30				

TiD-extra
Industrial Technologies d.o.o.

FASTENING

SHOCKWAVE™ KNUCKLE™ offset attachment

Impact rated: suitable to use with latest 18V impact drivers as well as cordless drill drivers.

Very compact offset attachment.

Ideally suited to working in confined and limited spaces.

Solid metal construction to absorb impact action.

0° and 30° positions.

1/4" Hex shank fits directly into the chuck preventing slippage.

* Height when 30° tilted 40 mm



* Height when 30° tilted 40 mm

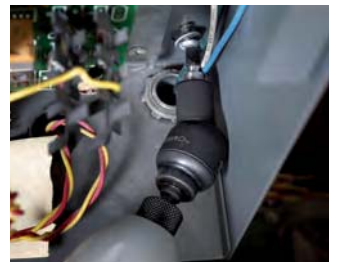

Description	Pack quantity	Min. order quantity	Article Number	EAN Code
Counter display KNUCKLE™ set (11pc)	11	10	4932459781	4058546029531
1 x KNUCKLE™, 1 x PH1 / 2 x PH2, 1 x PZ1 / 2 x PZ2 / 1 x PZ3, 1 x TX15 / 1 x TX20 / 1 x TX25				

OSD2 - Offset screwdriver/ drill angle attachment



Description	Pack quantity	Min. order quantity	Article Number	EAN Code
① OSD 2	1	1	4932352320	4002395369799
② Counter display 6 x OSD 2 (4932352320)	6	1	4932352321	4002395369805

Screwdriving bits





The ribs are cold formed to exact specification ensuring reduced wear from slippage. The tip is subjected to a special hardening process with temperatures up to 870°C.

The outcome is a bit with a hardness of 60 HRC. This extra hard tip ensures extra long life under constant use.

The body is manufactured from the highest quality S2 european steel.

The sign of quality: All bits are laser marked with the MILWAUKEE[®] logo and tip reception for easy identification.

	Type	Total length (mm)	Pack quantity	Min. order quantity	Article Number	EAN Code
Phillips 	PH 1	25	25	1	4932399586	4002395362363
	PH 2	25	25	1	4932399587	4002395362370
	PH 3	25	25	1	4932399588	4002395362387
Pozidrive 	PZ 1	25	25	1	4932399589	4002395362394
	PZ 2	25	25	1	4932399590	4002395362400
	PZ 3	25	25	1	4932399591	4002395362417
Torx 	TX 10	25	25	1	4932399594	4002395362448
	TX 15	25	25	1	4932399595	4002395362455
	TX 20	25	25	1	4932399596	4002395362462
	TX 25	25	25	1	4932399597	4002395362479
	TX 30	25	25	1	4932399599	4002395362493
	TX 40	25	25	1	4932399600	4002395362509

Screwdriving bit cassettes

This high quality cassette aimed at the professional user is available in 3 different assortments.

Slimline pocket design: 110 mm x 65 mm x 15 mm.

Secure latch system - easy opening and safe closing.

Extra side compartment accepts either 50 mm screwdriving bits or drill bits.

Front window to protect bits from dust.

High quality screwdriving bits with hardness of 60 HRC and 1/4" Hex reception. 25 mm bits manufactured according to DIN 3126 - C 6.3. 50 mm bits are manufactured according to DIN 3126 - E 6.3.

Magnetic bit holder with quick release clutch.

Description	Pack quantity	Min. order quantity	Article Number	EAN Code
Compact screwdriving bit set (12pc)				
25 mm: SL 0.8 x 5.5 mm x 1. 25 mm: PH 1 x 1 / PH 2 x 2 / PH 3 x 1. 25 mm: PZ 1 x 1 / PZ 2 x 2 / PZ 3 x 1. 50 mm: PH 2 x 1. 50 mm: PZ 2 x 1. Magnetic bit holder with quick release clutch	12	1	4932399513	4002395361601



Screwdriving bits sets

Description	Pack quantity	Min. order quantity	Article Number	EAN Code
Screwdriving bit set (35pc)				
① Screwdriving bits 25 mm length: PH 1 x 2 / PH 2 x 3 / PH 3 x 2. PZ 1 x 2 / PZ 2 x 3 / PZ 3 x 2. TX 10 x 2 / TX 15 x 2 / TX 20 x 3. TX 25 x 3 / TX 30 x 2 / TX 40 x 2. Screwdriving bits 50 mm length: PH 1 x 1 / PH 2 x 1. PZ 1 x 1 / PZ 2 x 1. TX 20 x 1 / TX 25 x 1. 1 x magnetic bit holder with 1/4" Hex reception	35	6	4932352068	4002395367214
Screwdriving bit set (27pc)				
② Screwdriving bits 25 mm length: PH 1 x 2 / PH 2 x 2 / PH 3 x 1. PZ 1 x 2 / PZ 2 x 4 / PZ 3 x 2. TX 10 x 2 / TX 15 x 3 / TX 20 x 3. TX 25 x 3 / TX 30 x 1 / TX 40 x 1. Magnetic bit holder with quick release clutch.	27	1	4932352747	4002395374052



Magnetic bit holders

Description	Pack quantity	Min. order quantity	Article Number	EAN Code
① Magnetic bit holder with quick release clutch, total length 58 mm	1	1	4932373483	4002395351060
② Magnetic bit holder for drywall	1	1	4932430179	4002395378401





With the most skilled tradesmen in mind, MILWAUKEE® continues to increase its variety of impact wrenches to allow for further versatility on the jobsite. Alongside this, MILWAUKEE® have widened our range of SHOCKWAVE™ IMPACT DUTY sockets by introducing even more reception sizes to our extensive line of products.



1/4"



NEW
3/8"



1/2"



3/4"



1"

1/4" SHOCKWAVE™ IMPACT DUTY impact sockets - deep

SHOCKWAVE™ IMPACT DUTY steel (Chrome-Molybdenum) is high quality alloy steel which provides ultimate strength and durability.

Best fitting thanks to 6 gripping points.

Recessed corners allow torque to be transferred across the flats of the socket rather than producing stress on the points or corners.

Thin wall construction provides access to tight spaces.

Deep wall construction provides clearance for protruding bolts.

Laser etched size markings for easy identification and won't wear off.

A (mm)	B (mm)	C (mm)	D (mm)	E (mm)	For anchor thread size	Pack quantity	Min. order quantity	Article Number	EAN Code
1/4" square	4	50	3	7.7	M2	1	1	4932472283	4058546339296
1/4" square	4.5	50	3.5	8	-	1	1	4932472284	4058546339302
1/4" square	5	50	4	8.8	M2.5	1	1	4932472285	4058546339319
1/4" square	5.5	50	4.5	9.5	M3	1	1	4932472286	4058546339326
1/4" square	6	50	6	9.8	M3.5	1	1	4932478000	4058546339333
1/4" square	7	50	6	11.4	M4	1	1	4932478001	4058546339340
1/4" square	8	50	7.5	12.5	M5	1	1	4932478002	4058546339357
1/4" square	9	50	7.5	13.8	-	1	1	4932478003	4058546339364
1/4" square	10	50	9	14.3	M6	1	1	4932478004	4058546339371
1/4" square	11	50	11	16.8	M7	1	1	4932478005	4058546339388
1/4" square	12	50	12	17.8	-	1	1	4932478006	4058546339395
1/4" square	13	50	12	18.8	M8	1	1	4932478007	4058546339401

1/4" SHOCKWAVE™ IMPACT DUTY socket set (21pc)

12 x 1/4" sockets: 4 / 4.5 / 5 / 5.5 / 6 / 7 / 8 / 9 / 10 / 11 / 12 / 13 mm. 50 mm total length. 6 x screwdriving bits 25 mm in length: PH 2, PZ 2, TX 15, TX 20, TX 25, TX 30. 1 x socket adaptor 1/4" Hex > 1/4" square drive. 1 x bit adaptor 1/4" square (F) > 1/4" Hex. 1 x 60mm magnetic bit holder for screwdriving bits

① 21 1 4932352862 4002395375202

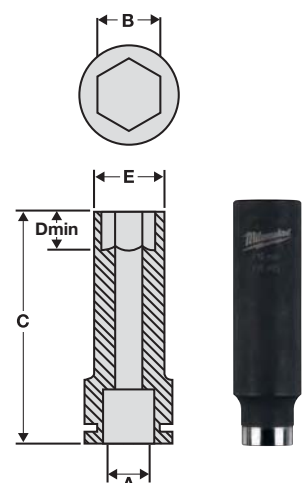

①



SHOCKWAVE™ IMPACT DUTY



TM

3/8" SHOCKWAVE™ IMPACT DUTY impact sockets

NEW

A (mm)	B (mm)	C (mm)	D (mm)	E (mm)	For anchor thread size	Pack quantity	Min. order quantity	Article Number	EAN Code
3/8" square	8	28	4.8	12.5	M5	1	1	4932478008	4058546339418
3/8" square	10	28	5.3	15	M6	1	1	4932478009	4058546339425
3/8" square	11	30	5.8	17	-	1	1	4932478010	4058546339432
3/8" square	12	30	6.4	18.8	M7	1	1	4932478011	4058546339449
3/8" square	13	30	6.9	18.8	M8	1	1	4932478012	4058546339456
3/8" square	14	30	7.4	19.8	M9	1	1	4932478013	4058546339463
3/8" square	15	30	8	21.8	-	1	1	4932478014	4058546339470
3/8" square	16	30	8.5	23.8	-	1	1	4932478015	4058546339487
3/8" square	17	32	9.7	23.8	M10	1	1	4932478016	4058546339494
3/8" square	18	32	10.9	25.8	-	1	1	4932478017	4058546339500
3/8" square	19	32	11.9	25.8	M12	1	1	4932478018	4058546339517
3/8" square	21	32	12.9	29.8	-	1	1	4932478019	4058546339524
3/8" square	22	32	13.9	31.8	M14	1	1	4932478020	4058546339531
3/8" SHOCKWAVE™ IMPACT DUTY socket set (8 pc)									
① 8 x impact sockets: 8 / 10 / 12 / 13 / 16 / 17 / 18 / 19 mm						8	1	4932478288	4058546344658

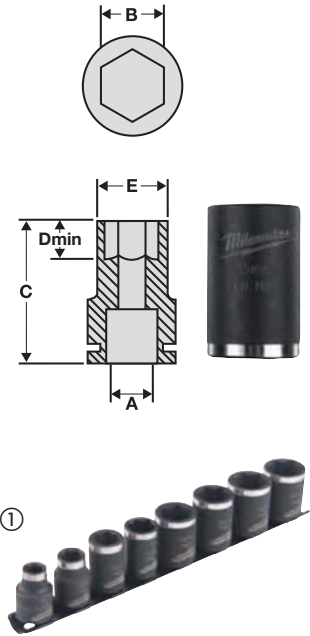

FASTENING

3/8" SHOCKWAVE™ IMPACT DUTY impact sockets - deep

NEW

A (mm)	B (mm)	C (mm)	D (mm)	E (mm)	For anchor thread size	Pack quantity	Min. order quantity	Article Number	EAN Code
3/8" square	8	63	4.8	12.5	M5	1	1	4932478021	4058546339548
3/8" square	10	63	5.3	15	M6	1	1	4932478022	4058546339555
3/8" square	11	63	5.8	17	-	1	1	4932478023	4058546339562
3/8" square	12	63	6.4	18.8	M7	1	1	4932478024	4058546339579
3/8" square	13	63	6.9	18.8	M8	1	1	4932478025	4058546339586
3/8" square	14	63	7.4	19.8	M9	1	1	4932478026	4058546339593
3/8" square	15	63	8	21.8	-	1	1	4932478027	4058546339609
3/8" square	16	63	8.5	23.8	-	1	1	4932478028	4058546339616
3/8" square	17	63	9.7	23.8	M10	1	1	4932478029	4058546339623
3/8" square	18	63	10.9	25.8	-	1	1	4932478030	4058546339630
3/8" square	19	63	11.9	25.8	M12	1	1	4932478031	4058546339647
3/8" square	21	63	12.9	29.8	-	1	1	4932478032	4058546339654
3/8" square	22	63	13.9	31.8	M14	1	1	4932478033	4058546339661
3/8" SHOCKWAVE™ IMPACT DUTY socket set deep (8 pc)									
① 8 x deep impact sockets: 8 / 10 / 12 / 13 / 16 / 17 / 18 / 19 mm						8	1	4932478289	4058546344665

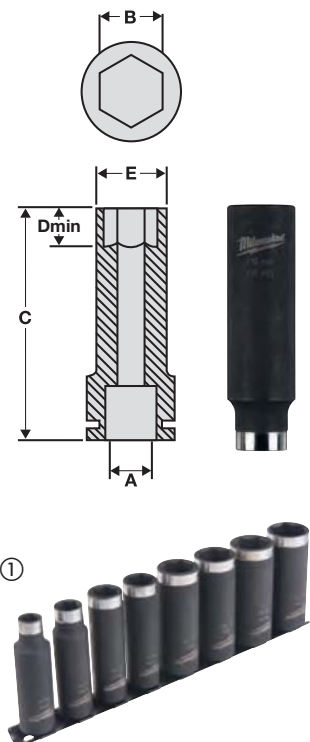

3/8" impact sockets - extensions

NEW

Description	Total length (mm)	Pack quantity	Min. order quantity	Article Number	EAN Code
3/8" extension - 150 mm	150	1	1	4932478055	4058546339883
3/8" extension - 250 mm	250	1	1	4932478056	4058546339890



3/8" impact sockets - adaptors

NEW

Description	Total length (mm)	Pack quantity	Min. order quantity	Article Number	EAN Code
Socket adaptor: 3/8" square - 1/2" square	37	1	1	4932478051	4058546339845
Socket adaptor: 3/8" square - 1/4" square	32	1	1	4932478052	4058546339852



SHOCKWAVE™ IMPACT DUTY



TM

1/2" SHOCKWAVE™ IMPACT DUTY impact sockets

NEW

A (mm)	B (mm)	C (mm)	D (mm)	E (mm)	For anchor thread size	Pack quantity	Min. order quantity	Article Number	EAN Code
1/2" square	8	38	4.8	14.5	M5	1	1	4932478034	4058546339678
1/2" square	10	38	5.3	17	M6	1	1	4932478035	4058546339685
1/2" square	11	38	5.8	18	-	1	1	4932478036	4058546339692
1/2" square	12	38	6.4	19	M7	1	1	4932478037	4058546339708
1/2" square	13	38	6.9	20	M8	1	1	4932478038	4058546339715
1/2" square	14	38	7.4	22	M9	1	1	4932478039	4058546339722
1/2" square	15	38	8.0	23.4	-	1	1	4932478040	4058546339739
1/2" square	16	38	8.5	23.8	-	1	1	4932478041	4058546339746
1/2" square	17	38	9.7	25.8	M10	1	1	4932478042	4058546339753
1/2" square	18	38	10.9	25.8	-	1	1	4932478043	4058546339760
1/2" square	19	40	12.4	27.8	M12	1	1	4932478044	4058546339777
1/2" square	21	40	12.9	29.8	-	1	1	4932478045	4058546339784
1/2" square	22	42	13.9	31.8	M14	1	1	4932478046	4058546339791
1/2" square	24	44	14.9	33.8	M16	1	1	4932478047	4058546339807
1/2" square	27	46	15.9	37.8	M18	1	1	4932478048	4058546339814
1/2" square	30	46	18.1	41.8	M20	1	1	4932478049	4058546339821
1/2" square	32	46	18.8	43.8	M22	1	1	4932478050	4058546339838
1/2" SHOCKWAVE™ IMPACT DUTY socket set (11 pc)									
① 9 x impact sockets: 10 / 12 / 13 / 16 / 17 / 18 / 19 / 21 / 24 mm. 1 x 150 mm extension. 1 x 1/4" Hex - 1/2" SQ adaptor						11	1	4932478290	4058546344672

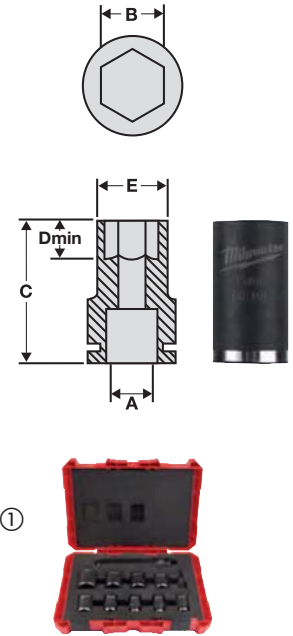

FASTENING

TiD-extra
Industrial Technologies d.o.o.

1/2" SHOCKWAVE™ IMPACT DUTY impact sockets - deep

A (mm)	B (mm)	C (mm)	D (mm)	E (mm)	For anchor thread size	Pack quantity	Min. order quantity	Article Number	EAN Code
1/2" square	8	78	12	15	M5	1	1	4932352847	4002395375059
1/2" square	10	78	12	17	M6	1	1	4932352848	4002395375066
1/2" square	11	78	12	18	-	1	1	4932352849	4002395375073
1/2" square	12	78	12	19	M7	1	1	4932352850	4002395375080
1/2" square	13	78	12	20	M8	1	1	4932352851	4002395375097
1/2" square	14	78	15	22	M9	1	1	4932352852	4002395375103
1/2" square	15	78	15	23.4	-	1	1	4932471737	4058546296360
1/2" square	16	78	15	23.8	-	1	1	4932352853	4002395375110
1/2" square	17	78	18	25.8	M10	1	1	4932352854	4002395375127
1/2" square	18	78	20	25.8	-	1	1	4932471738	4058546296377
1/2" square	19	78	21	27.8	M12	1	1	4932352855	4002395375134
1/2" square	21	78	24	29.8	-	1	1	4932352856	4002395375141
1/2" square	22	78	24	31.8	M14	1	1	4932471166	4058546287948
1/2" square	24	78	24	33.8	M16	1	1	4932352857	4002395375158
1/2" square	27	78	24	37.8	M18	1	1	4932352858	4002395375165
1/2" square	30	78	24	41.8	M20	1	1	4932352859	4002395375172
1/2" square	32	78	24	43.8	M22	1	1	4932352860	4002395375189
1/2" SHOCKWAVE™ IMPACT DUTY socket set (10 pc)									
① 10 x deep impact sockets: 8 / 10 / 11 / 12 / 13 / 14 / 16 / 17 / 19 / 21 mm						10	1	4932352861	4002395375196

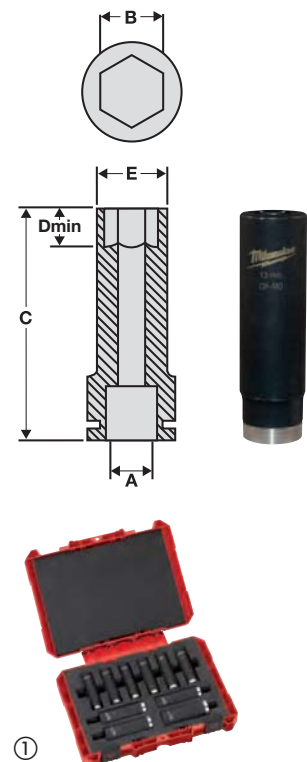

1/2" SHOCKWAVE™ IMPACT DUTY automotive impact socket set

Description	Pack quantity	Min. order quantity	Article Number	EAN Code
Automotive impact socket set (3pc) 17 mm, 19 mm and 21 mm 1/2" impact sockets	3	1	4932451568	4002395140091



1/2" impact sockets - extensions

NEW

Description	Total length (mm)	Pack quantity	Min. order quantity	Article Number	EAN Code
1/2" extension - 150 mm	150	1	1	4932478057	4058546339906
1/2" extension - 250 mm	250	1	1	4932478058	4058546339913



1/2" impact sockets - adaptors

NEW

Description	Total length (mm)	Pack quantity	Min. order quantity	Article Number	EAN Code
① Socket adaptor: 1/2" square - 1/4" Hex. To accept screwdriving bits	50	1	1	4932471828	4058546297275
② Socket adaptor: 1/2" square - 3/8" square	38	1	1	4932478053	4058546339869



1/2" impact TX bit sockets

NEW

One-piece design TX bit and socket with 1/2" internal square drive reception according to DIN 3121 / ISO 1174-2.

Suitable for higher torque fastening applications, fits directly onto 1/2" impact tools.

Description	Tool reception	Pack quantity	Min. order quantity	Article Number	EAN Code
TX30 1/2" impact bit socket	1/2" square	1	1	4932478059	4058546339920
TX40 1/2" impact bit socket	1/2" square	1	1	4932478060	4058546339937
TX45 1/2" impact bit socket	1/2" square	1	1	4932478061	4058546339944
TX50 1/2" impact bit socket	1/2" square	1	1	4932478062	4058546339951



1/2" impact HEX bit sockets

NEW

One-piece design HEX bit and socket with 1/2" internal square drive reception according to DIN 3121 / ISO 1174-2.

Suitable for higher torque fastening applications, fits directly onto 1/2" impact tools.

Description	Tool reception	Pack quantity	Min. order quantity	Article Number	EAN Code
HEX5 1/2" impact bit socket	1/2" square	1	1	4932478063	4058546339968
HEX6 1/2" impact bit socket	1/2" square	1	1	4932478064	4058546339975
HEX8 1/2" impact bit socket	1/2" square	1	1	4932478065	4058546339982
HEX10 1/2" impact bit socket	1/2" square	1	1	4932478066	4058546339999
HEX12 1/2" impact bit socket	1/2" square	1	1	4932478067	4058546340001



SHOCKWAVE™ IMPACT DUTY



TM

3/4" SHOCKWAVE™ IMPACT DUTY impact sockets - deep

SHOCKWAVE™ IMPACT DUTY steel (Chrome-Molybdenum) is high quality alloy steel which provides ultimate strength and durability. According to DIN 3129 / ISO 2725-2, internal square drive according to DIN 3121 / ISO 1174-2.

6 gripping points for precise fitting.

Recessed corners allow torque to be transferred across the flats of the socket rather than producing stress on the points or corners.

Deep wall construction provides clearance for protruding bolts.

Laser etched size markings for easy identification and won't wear off.

A (mm)	B (mm)	C (mm)	D (mm)	E (mm)	For anchor thread size	Pack quantity	Min. order quantity	Article Number	EAN Code
3/4" square	17	90	38	30	M10	1	1	4932471642	4058546295417
3/4" square	19	90	38	33	M12	1	1	4932471643	4058546295424
3/4" square	21	90	38	35	-	1	1	4932471644	4058546295431
3/4" square	22	90	38	37	M14	1	1	4932471645	4058546295448
3/4" square	24	90	38	39	M16	1	1	4932471646	4058546295455
3/4" square	27	90	38	43	M18	1	1	4932471647	4058546295462
3/4" square	30	90	38	46	M20	1	1	4932471648	4058546295479
3/4" square	32	90	38	49	M22	1	1	4932471649	4058546295486
3/4" square	33	90	38	51	-	1	1	4932471650	4058546295493
3/4" square	36	90	38	54	M24	1	1	4932471651	4058546295509
3/4" square	41	90	38	60	M27	1	1	4932471652	4058546295516
3/4" square	46	90	38	66	M30	1	1	4932471653	4058546295523
3/4" square	50	90	38	71	M33	1	1	4932471654	4058546295530

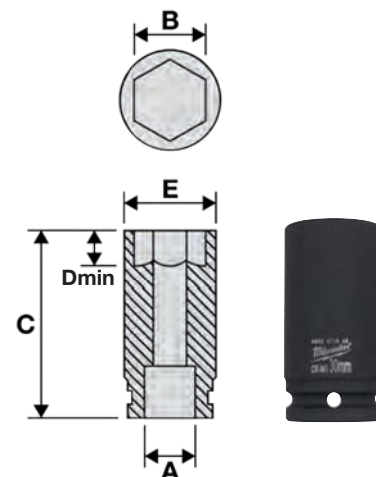

FASTENING

3/4" impact sockets - extensions

Impact rated socket extensions for facilitated bolt access in restricted areas.

SHOCKWAVE™ IMPACT DUTY steel (chrome-molybdenum) is high quality alloy steel which provides ultimate strength and durability.

Description	Total length (mm)	Pack quantity	Min. order quantity	Article Number	EAN Code
① 3/4" extension - 150 mm	150	1	1	4932471655	4058546295547
② 3/4" extension - 250 mm	250	1	1	4932471656	4058546295554



3/4" impact sockets - adaptors

Square drive adaptor according to DIN 3121 / ISO 1174 with ball lock.

3/4" adaptor and reducer (F) to accept different square drive sizes (M), making an existing socket system more flexible in use.

SHOCKWAVE™ IMPACT DUTY steel (chrome-molybdenum) is high quality alloy steel which provides ultimate strength and durability.

Description	Total length (mm)	Pack quantity	Min. order quantity	Article Number	EAN Code
① Socket adaptor: 3/4" square - 1/2" square	56	1	1	4932471657	4058546295561
② Socket adaptor: 3/4" square - 1" square	63	1	1	4932471658	4058546295578



3/4" impact sockets - security accessories

Description	Pack quantity	Min. order quantity	Article Number	EAN Code
① 3/4" O-ring for sockets 17-49 mm	1	1	4932471659	4058546295585
① 3/4" O-ring for sockets 50-70 mm	1	1	4932471660	4058546295592
② 3/4" connection pin for sockets 17-49 mm	1	1	4932471661	4058546295608
② 3/4" connection pin for sockets 50-70 mm	1	1	4932471662	4058546295615



TiD-extra
Industrial Technologies d.o.o.

1" SHOCKWAVE™ IMPACT DUTY impact sockets - standard

SHOCKWAVE™ IMPACT DUTY steel (Chrome-Molybdenum) is high quality alloy steel which provides ultimate strength and durability. According to DIN 3129 / ISO 2725-2, internal square drive according to DIN 3121 / ISO 1174-2.

6 gripping points for best precise fit.

Recessed corners allow torque to be transferred across the flats of the socket rather than producing stress on the points or corners. Laser etched size markings for easy identification and won't wear off.

A (mm)	B (mm)	C (mm)	D (mm)	E (mm)	For anchor thread size	Pack quantity	Min. order quantity	Article Number	EAN Code
1" square	27	58	14	46	M18	1	1	4932471663	4058546295622
1" square	30	60	16	49	M20	1	1	4932471664	4058546295639
1" square	32	61	19	53	M22	1	1	4932471665	4058546295646
1" square	33	61	19	54	-	1	1	4932471666	4058546295653
1" square	36	65	19	57	M24	1	1	4932471667	4058546295660
1" square	41	65	23	63	M27	1	1	4932471668	4058546295677
1" square	46	74	23	69	M30	1	1	4932471669	4058546295684
1" square	50	74	26	74	M33	1	1	4932471670	4058546295691
1" square	55	85	28	81	M36	1	1	4932471671	4058546295707
1" square	60	89	31	87	M39	1	1	4932471672	4058546295714
1" square	65	93	32	93	M42	1	1	4932471673	4058546295721
1" square	70	98	35	99	M45	1	1	4932471674	4058546295738

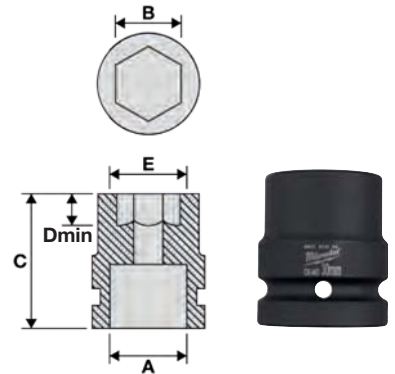

1" impact sockets - extensions

Impact rated socket extensions for facilitated bolt access in restricted areas.

SHOCKWAVE™ IMPACT DUTY steel (chrome-molybdenum) is high quality alloy steel which provides ultimate strength and durability.

Description	Total length (mm)	Pack quantity	Min. order quantity	Article Number	EAN Code
① 1" extension - 175 mm	175	1	1	4932471675	4058546295745
② 1" extension - 300 mm	300	1	1	4932471676	4058546295752



1" impact sockets - adaptors

Square drive adaptor according to DIN 3121 / ISO 1174 with ball lock.

1" reducer (F) to accept different square drive sizes (M), making an existing socket system more flexible in use.

SHOCKWAVE™ IMPACT DUTY steel (chrome-molybdenum) is high quality alloy steel which provides ultimate strength and durability.

Description	Total length (mm)	Pack quantity	Min. order quantity	Article Number	EAN Code
① Socket adaptor: 1" square - 3/4" square	75	1	1	4932471677	4058546295769



1" impact sockets - security accessories

Pin and o-ring accessories to secure 1" impact sockets safely.

Description	Pack quantity	Min. order quantity	Article Number	EAN Code
① 1" O-ring	1	1	4932471678	4058546295776
② 1" connection pin	1	1	4932471679	4058546295783



Nails

Type	Wire gauge	Dimensions (mm)	Total length (mm)	Nail angle	Material	Pack quantity	Min. order quantity	Article Number	EAN Code	
① Brad nails for M18FN18GS	18	1.05 x 1.25	16	0°	Resin Coated. Galvanised	10,000	1	4932459124	4002395287796	
	18	1.05 x 1.25	19	0°	Resin Coated. Galvanised	10,000	1	4932459125	4002395288403	
	18	1.05 x 1.25	25	0°	Resin Coated. Galvanised	5,000	1	4932459126	4002395288410	
	18	1.05 x 1.25	30	0°	Resin Coated. Galvanised	5,000	1	4932459127	4002395288427	
	18	1.05 x 1.25	32	0°	Resin Coated. Galvanised	5,000	1	4932459128	4002395288434	
	18	1.05 x 1.25	40	0°	Resin Coated. Galvanised	5,000	1	4932459129	4002395288441	
	18	1.05 x 1.25	45	0°	Resin Coated. Galvanised	4,000	1	4932459130	4002395288458	
	18	1.05 x 1.25	50	0°	Resin Coated. Galvanised	4,000	1	4932459131	4002395288465	
	18	1.05 x 1.25	16	0°	Stainless / Rust free	10,000	1	4932459132	4002395288472	
	18	1.05 x 1.25	19	0°	Stainless / Rust free	10,000	1	4932459133	4002395288489	
	18	1.05 x 1.25	25	0°	Stainless / Rust free	5,000	1	4932459134	4002395288496	
	18	1.05 x 1.25	30	0°	Stainless / Rust free	5,000	1	4932459135	4002395289103	
	18	1.05 x 1.25	32	0°	Stainless / Rust free	5,000	1	4932459136	4002395289110	
	18	1.05 x 1.25	40	0°	Stainless / Rust free	5,000	1	4932459137	4002395289127	
	18	1.05 x 1.25	45	0°	Stainless / Rust free	4,000	1	4932459138	4002395289134	
	18	1.05 x 1.25	50	0°	Stainless / Rust free	4,000	1	4932459139	4002395289141	
	② Brad nails for M18CN16GA	16	1.50 x 1.65	32	20°	Galvanised	2,000	1	4932459140	4002395289158
		16	1.50 x 1.65	38	20°	Galvanised	2,000	1	4932459141	4002395289165
16		1.50 x 1.65	45	20°	Galvanised	2,000	1	4932459142	4002395289172	
16		1.50 x 1.65	50	20°	Galvanised	2,000	1	4932459143	4002395289189	
16		1.50 x 1.65	64	20°	Galvanised	2,000	1	4932459144	4002395289196	
③ D head nails for M18FFN	-	Ø2.8	50	34°	Ring Shank	4,000	1	4932478396	4058546345877	
	-	Ø2.8	63	34°	Ring Shank	4,000	1	4932478397	4058546345884	
	-	Ø2.8	75	34°	Ring Shank	4,000	1	4932478398	4058546345891	
	-	Ø2.8	80	34°	Ring Shank	3,000	1	4932478399	4058546345907	
	-	Ø3.1	90	34°	Ring Shank	3,000	1	4932478400	4058546345914	
	-	Ø2.8	63	34°	Ring Shank. Galvanised	4,000	1	4932478401	4058546345921	
	-	Ø2.8	75	34°	Ring Shank. Galvanised	4,000	1	4932478402	4058546345938	
	-	Ø3.1	80	34°	Ring Shank. Galvanised	3,000	1	4932478403	4058546345945	
	-	Ø3.1	90	34°	Ring Shank. Galvanised	3,000	1	4932478404	4058546345952	

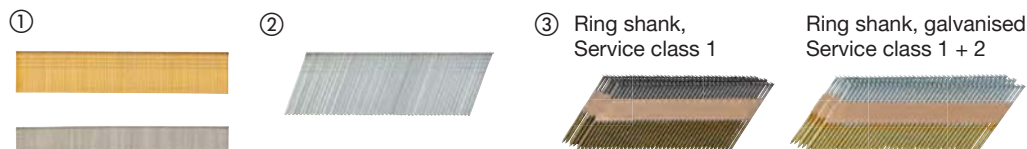

CE EN 14592 / EUROCODE 5

TiD-extra
Industrial Technologies d.o.o.

FASTENING

Staples

Type	Width (mm)	Dimensions (mm)	Total length (mm)	Material	Pack quantity	Min. order quantity	Article Number	EAN Code
① Staples for M18FNCS18GS	5.7	1.05 x 1.25	15	Resin Coated. Galvanised	9,200	1	4932478389	4058546345808
	5.7	1.05 x 1.25	20	Resin Coated. Galvanised	9,200	1	4932478390	4058546345815
	5.7	1.05 x 1.25	25	Resin Coated. Galvanised	4,600	1	4932478391	4058546345822
	5.7	1.05 x 1.25	30	Resin Coated. Galvanised	4,600	1	4932478392	4058546345839
	5.7	1.05 x 1.25	32	Resin Coated. Galvanised	4,600	1	4932478393	4058546345846
	5.7	1.05 x 1.25	36	Resin Coated. Galvanised	4,600	1	4932478394	4058546345853
② Staples for M12BST	10.6	0.5 x 1.27	6	Galvanised	1,200	1	4932459145	4002395289806
	10.6	0.5 x 1.27	8	Galvanised	1,200	1	4932459146	4002395289813
	10.6	0.5 x 1.27	14	Galvanised	600	1	4932459147	4002395289820

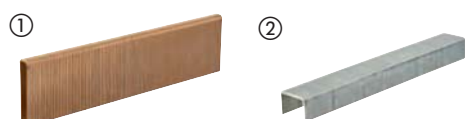



SAWZALL™

BLADE SELECTION GUIDE

1. Identify the material to be cut in the rows below.
2. Follow the row across to find best/compatible performance.

BEST PERFORMANCE

GOOD PERFORMANCE

TiD-extra
Industrial Technologies d.o.o.



DEMOLITION BLADES

AX™ CARBIDE



AX™



THIN KERF



METAL CUTTING BLADES

TORCH™ NITRUS CARBIDE



TORCH™ CARBIDE



TORCH™



THIN KERF



UNIVERSAL BLADES

WRECKER™ CARBIDE



WRECKER™



Art. Nr. 48005092



Art. Nr. 48005293



Art. Nr. 48005093



WOOD CUTTING BLADES

Art. Nr. 48001075



Art. Nr. 48001077













Art. Nr. 48001079



SPECIAL APPLICATION BLADES

DIAMOND GRIT



TPI	BLADE THICKNESS (MM)											
		THICK METAL > 4MM	MEDIUM METAL 1.5 - 4MM	THIN METAL 0.5 - 3MM	STAINLESS STEEL	CAST IRON	NON FERROUS METALS (CU/AL)	WOOD	GREEN WOOD	WOOD WITH NAILS & SCREWS	PALLETS	PVC Pipe
5	1.27							Black		Black		
5	1.60							Black		Black		
5	1.27							Red		Red		
7	1.27	Black	Black/Red		Black/Red	Black	Black					
7	1.27	Black	Black/Red		Black/Red	Red	Black					
10	1.10	Faster/Rougher	Faster/Rougher									
14	1.10	↑↓	↑↓	Black	Red							
18	1.10	Slower/Smother	Slower/Smother		Red							
14	0.90	Faster/Rougher	Faster/Rougher		Red							Black
18	0.90	↑↓	↑↓	Black	Red							Black
25	0.90	Slower/Smother	Slower/Smother		Red							Black
6	1.27	Black	Black/Red			Red	Black				Black	
7/11	1.60	Black	Black				Black				Black	
10	0.90	Red	Black				Black					
10/14	0.90	Red	Black				Black			Red	Black	Black
8/12	1.27	Red	Black				Black			Red	Black	Black
4.2	1.27							Black	Red			
5.5/6	1.27							Black	Black			
8.5	1.27							Black				
GRIT	1.10					Black						



Nothing but **HEAVY DUTY.**[™]

INTRODUCING

NITRUS CARBIDE[™]

TORCH[™]
NITRUS CARBIDE

**CUT
TOUGHER**

Our SAWZALL[™] The TORCH[™] with NITRUS CARBIDE[™] for CAST IRON and other thick metals is the next generation of carbide teeth technology. The blade delivers 3X the life of existing carbide teeth reciprocating saw blades to continuously make the toughest cast iron removals on the job.



3x
LONGER LIFE*

*vs standard Carbide blades

TiD-extra
Industrial Technology

CARBIDE TEETH

CUT LONGER. CUT MORE. CUT FASTER.

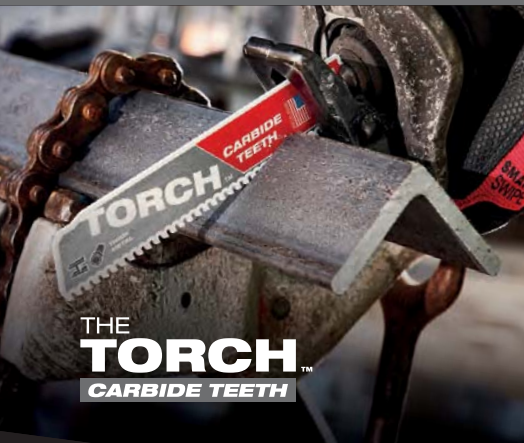

THE
TORCH[™]
CARBIDE TEETH



AX[™]
CARBIDE TEETH



NEW

THE
WRECKER[™]
CARBIDE TEETH

x50
LONGER LIFE

This blade delivers up to 50X life over bi-metal standard blades

1000
MORE CUTS

The Ax with Carbide Teeth is optimized for Cordless Recip Saws delivering over 25% more cuts per charge

x2
FASTER CUTS

This blade delivers up to 2X faster cuts than bi-metal standard blades

Metal: Heavy duty TORCH™ with NITRUS CARBIDE™

NEW

The TORCH™ blades with NITRUS CARBIDE™ teeth is the next generation of carbide technology.









This special carbide NITRUS blend is designed to cut 3x longer than existing standard carbide teeth blades.

Constructed with a 7 Tpi design for fast starts and smooth cuts, large gullets for easy chip ejection, and a unique carbide blend, the TORCH™ Blades with NITRUS CARBIDE™ are designed to last the longest and cut the fastest in cast iron / SML pipe and other thick metals.

Thick 1.27 mm robust blade body for precise straight cuts.

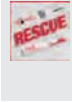
25 mm blade height for improved stability and minimum vibration.

Best performance in all thick metals and especially cast iron soil, waste and drainage pipes

Blade length (mm)	Tooth pitch (mm)	Teeth per inch	Ref. No.							Pack quantity	Min. order quantity	Article Number	EAN Code
													
150	3.6	7	-	5 - 13	Ø 10 - 100	5 - 13	Ø 10 - 100	5 - 13	Yes	1 5	1 1	48005261 48005561	045242569694 045242569717
													
230	3.6	7	-	5 - 13	Ø 10 - 175	5 - 13	Ø 10 - 175	5 - 13	Yes	1 5	1 1	48005262 48005562	045242569724 045242569748
													
300	3.6	7	-	5 - 13	Ø 10 - 250	5 - 13	Ø 10 - 250	5 - 13	Yes	1 5	1 1	48005263 48005563	045242569755 045242569779

TiD-extra
Industrial Technologies d.o.o.

SAWING, CUTTING AND GRINDING

THE TORCH™ WITH NITRUS CARBIDE™ VS AIRBUS A319



Scan the QR Code to see our full video.

Metal: Heavy duty TORCH™ carbide teeth

Carbide teeth provide for longest life in thick metals - up to 50x more life compared to Bi-Metal blades
 Thick 1.27 mm robust blade body for precise straight cuts
 25 mm blade height for improved stability and minimum vibration

THE
TORCH™
 CARBIDE TEETH

Blade length (mm)	Tooth pitch (mm)	Teeth per inch	Ref. No.								Pack quantity	Min. order quantity	Article Number	EAN Code
150	3.6	7	-	5 - 13	Ø 10 - 100	5 - 13	Ø 10 - 100	5 - 13	Yes	Yes	1	1	48005201	045242521036
											5	1	48005501	045242520862
230	3.6	7	-	5 - 13	Ø 10 - 175	5 - 13	Ø 10 - 175	5 - 13	Yes	Yes	1	1	48005202	045242520787
											5	1	48005502	045242520879
300	3.6	7	-	5 - 13	Ø 10 - 250	5 - 13	Ø 10 - 250	5 - 13	Yes	Yes	1	1	48005203	045242520794
											5	1	48005503	045242520886

Wood with nails: Heavy duty AX™ carbide teeth demolition blades

AX™
 CARBIDE TEETH



Up to 50x longer life than standard Bi-Metal blades. Carbide teeth deliver long life and extreme durability in the toughest applications. Cuts through hardened screws and fasteners.

Up to 2x faster than standard Bi-Metal blades. A fast and aggressive 5 Tpi tooth pattern allows for the fastest cutting in nail embedded wood and a wide range of construction materials (wood/nails/bolts/screws/cast iron/asphalt roofing felt shingles).

Up to 25% more cuts per charge vs. standard Bi-Metal blades. Optimised for use with cordless reciprocating saws.

FANG TIP™: For faster plunge cutting and reaching into restricted areas.

NAIL GUARD™: Protects the tooth during nail impacts for increased durability and lifetime.

Sloped shape: Excellent for plunge cutting and reaching into restricted areas.

Blade length (mm)	Tooth pitch (mm)	Teeth per inch	Ref. No.								Pack quantity	Min. order quantity	Article Number	EAN Code
150	5	5	-	10 - 100	10 - 100	Ø 10 - 100	Yes	Yes	Yes	Yes	1	1	48005221	045242483716
											5	1	48005521	045242521104
230	5	5	-	10 - 175	10 - 175	Ø 10 - 175	Yes	Yes	Yes	Yes	1	1	48005226	045242483723
											5	1	48005526	045242521111
300	5	5	-	10 - 250	10 - 250	Ø 10 - 250	Yes	Yes	Yes	Yes	1	1	48005227	045242483730
											5	1	48005527	045242521128

Multi material : Heavy duty WRECKER™ carbide teeth demolition blades

NEW

The multi material WRECKER™ with carbide teeth cuts all from thick metal, cast iron, nail embedded wood, hardened screws and fasteners.

Up to 50x longer life than standard Bi -metal blades. Carbide teeth deliver long life and extreme durability in the toughest applications.

Up to 25% more cuts per charge vs. standard Bi-Metal blades. Optimised for use with cordless tools.

FANG TIP™: For faster plunge cutting and reaching into restricted areas.

Thick 1.27mm robust blade body for precise straight cuts.

25 mm blade height for improved stability and minimum vibration.

Best for multi material demolition (wood with nails or hardened fastners, cast iron and thick metal)



Blade length (mm)	Tooth pitch (mm)	Teeth per inch	Ref. No.								Pack quantity	Min. order quantity	Article Number	EAN Code
150	4.2	6	-	5 - 13	Ø 10 - 100	5 - 13	Ø 10 - 100	Yes	Yes	Yes	1	1	48005241	045242567980
											5	1	48005541	045242568048
230	4.2	6	-	5 - 13	Ø 10 - 175	5 - 13	Ø 10 - 175	Yes	Yes	Yes	1	1	48005242	045242567997
											5	1	48005542	045242568055
300	4.2	6	-	5 - 13	Ø 10 - 250	5 - 13	Ø 10 - 250	Yes	Yes	Yes	1	1	48005243	045242568000
											5	1	48005543	045242568062



Wood with nails: Heavy duty AX™ demolition blades

THE AX™

FANG TIP™: For faster plunge cutting and reaching into restricted areas.
NAIL GUARD™: Protects the tooth during nail impacts for increased durability and lifetime.
Strong: Extra thick 1.60 mm body for maximum robustness and life making it ideal for wood with nails or bolts.
Fast: Aggressive 5 Tpi tooth geometry removes more material per stroke for faster cutting.
Sloped shape: Excellent for plunge cutting and reaching into restricted areas.
Shatter resistant: Bi-Metal construction allows the blade to bend and flex without breaking.

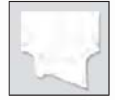

Blade length (mm)	Tooth pitch (mm)	Teeth per inch	Ref. No.							Pack quantity	Min. order quantity	Article Number	EAN Code
	5	5	-	10 - 100	10 - 100	10 - 50	Yes	Yes	Yes	5	1	48005021	045242082988
										25	1	48008021	045242082285
	5	5	-	10 - 175	10 - 175	10 - 50	Yes	Yes	Yes	5	1	48005026	045242082995
										25	1	48008026	045242082292
	5	5	-	10 - 250	10 - 250	10 - 50	Yes	Yes	Yes	5	1	48005027	045242083022
										25	1	48008027	045242082308

Wood with nails: THIN KERF demolition blades

FANG TIP™: For faster plunge cutting and reaching into restricted areas.
NAIL GUARD™: Protects the tooth during nail impacts for increased durability and lifetime.
Strong: 1.25 mm thick blade body for good strength and blade life making it ideal for wood with nails or bolts.
Fast: Aggressive 5 Tpi geometry removes more material per stroke for faster cutting.
Sloped shape: Excellent for plunge cutting and reaching into restricted areas.
Shatter resistant: Bi-Metal construction allows the blade to bend and flex without breaking.



Blade length (mm)	Tooth pitch (mm)	Teeth per inch	Ref. No.						Pack quantity	Min. order quantity	Article Number	EAN Code
	5	5	S611DF	10 - 100	10 - 100	Ø 10 - 100	Yes	Yes	5	1	48005035	045242082698
									50	1	48016035	045242084791
	5	5	S1111DF	10 - 175	10 - 175	Ø 10 - 175	Yes	Yes	5	1	48005036	045242082704
									50	1	48016036	045242084661
	5	5	S1411DF	10 - 250	10 - 250	Ø 10 - 250	Yes	Yes	5	1	48005037	045242082711
									50	1	48016037	045242084807

Multi material: Extra heavy duty WRECKER™ blades





THE WRECKER™

Strong and precise: Extra thick 1.60 mm blade body.







Bi-Metal construction: Excellent blade life and performance.

Tooth geometry: Aggressive strengthened tooth tip design and uniform gullet depth allows for more material to be removed per stroke for faster cutting.

Blade shape: Sloped - The sloped shape makes this blade ideal for plunge cutting. Most suited for cutting metal and for demolition applications (wood with nails).

Blade length (mm)	Tooth pitch (mm)	Teeth per inch	Ref. No.								Pack quantity	Min. order quantity	Article Number	EAN Code
150	3.6/2.3	7/11	-	4 - 10	Ø 10 - 100	4 - 10	4 - 10	Yes	Yes	Yes	5	1	48005701	045242082476
230	3.6/2.3	7/11	-	4 - 10	Ø 10 - 160	4 - 10	4 - 10	Yes	Yes	Yes	5	1	48005706	045242082483
											25	1	48008706	045242082520
300	3.6/2.3	7/11	-	4 - 10	Ø 10 - 180	4 - 10	4 - 10	Yes	Yes	Yes	5	1	48005711	045242082490

Wood / Metal / Plastic: Universal blades

Blade length (mm)	Tooth pitch (mm)	Teeth per inch	Ref. No.							Pack quantity	Min. order quantity	Article Number	EAN Code
150	2.5	10	-	3 - 10	3 - 10	5 - 50	No	Ø 3 - 50		5	1	48005092	045242082766
150	2.5/1.8	10/14	SS922VF	3 - 10	3 - 10	5 - 100	No	Ø 3 - 100		5	1	48005292	045242084067
										50	1	48016292	045242084081
200	2.5/1.8	10/14	-	3 - 10	3 - 10	5 - 175	Yes	Ø 3 - 160		5	1	48005293	045242084074
										50	1	48016293	045242084098
300	2.5/1.8	10/14	-	3 - 10	3 - 10	5 - 250	Yes	Ø 3 - 250		5	1	48005194	045242082926
150	3.2/2.1	8/12	-	3 - 10	3 - 10	5 - 100	Yes	Ø 3 - 100		5	1	48005091	045242082759
										50	1	48016091	045242084685
200	3.2/2.1	8/12	-	3 - 10	3 - 10	5 - 175	Yes	Ø 3 - 160		5	1	48005093	045242082773
										50	1	48016093	045242084708
										500	1	48016000	045242084951
300	3.2/2.1	8/12	-	3 - 10	3 - 10	5 - 250	Yes	Ø 3 - 250		5	1	48005094	045242082780
										50	1	48016094	045242084715

Metal: Heavy duty **TORCH™** demolition blades

THE **TORCH™**

STIFFEST



STRONGEST



LONGEST

**DOUBLE
DUTY
UPGRADE™**



Improved tooth geometry for best speed and double the lifetime.
Thick 1.06 mm robust blade body for precise cuts.
25 mm blade height for improved stability and minimum vibration.
Bi-Metal quality cutting teeth with 8 % cobalt the ultimate in performance and lifetime.



Stamped indentations around the reception strengthens the blade at its weakest point.



A grid iron pattern is built into the blade to make it more rigid with less tendency to bend or buckle for best durability and straight cuts.



Unique cryogenic heat treatment process gives:
– tougher teeth for cutting the hardest of metals
– up to 50% longer life vs. standard Bi Metal blades



Metal: Heavy duty TORCH™ demolition blades

Blade length (mm)	Tooth pitch (mm)	Teeth per inch	Ref. No.							Pack quantity	Min. order quantity	Article Number	EAN Code		
150	1.4	18	-	2 - 8	Ø 10 - 100	2 - 8	2 - 4	No	Yes	5 25	1 1	48005784 48008784	045242083084 045242082407		
150	1.4	18	-	2 - 8	Ø 10 - 100	2 - 8	2 - 4	No	Yes	5	1	48004784	045242081110		
230	1.4	18	-	2 - 8	Ø 10 - 160	2 - 8	2 - 4	No	Yes	5 25	1 1	48005788 48008788	045242083091 045242082421		
230	1.4	18	-	2 - 8	Ø 10 - 160	2 - 8	2 - 4	No	Yes	5	1	48004788	045242081134		
300	1.4	18	-	2 - 8	Ø 10 - 180	2 - 8	2 - 4	No	Yes	5 25	1 1	48005789 48008789	045242083107 045242082438		
150	1.8	14	-	3 - 10	Ø 10 - 100	3 - 10	3 - 7	Yes	Yes	5 25	1 1	48005782 48008782	045242083060 045242082391		
150	1.8	14	-	3 - 10	Ø 10 - 100	3 - 10	3 - 7	Yes	Yes	5	1	48004782	045242081097		
230	1.8	14	-	3 - 10	Ø 10 - 160	3 - 10	3 - 7	Yes	Yes	5 25	1 1	48005787 48008787	045242083077 045242082414		
230	1.8	14	-	3 - 10	Ø 10 - 160	3 - 10	3 - 7	Yes	Yes	5	1	48004787	045242081127		
150	2.5	10	-	4 - 10	Ø 10 - 100	4 - 10	4 - 10	Yes	Yes	5 25	1 1	48005712 48008712	045242083039 045242082377		
150	2.5	10	-	4 - 10	Ø 10 - 100	4 - 10	4 - 10	Yes	Yes	5	1	48004712	045242081073		
230	2.5	10	-	4 - 10	Ø 10 - 160	4 - 10	4 - 10	Yes	Yes	5 25	1 1	48005713 48008713	045242083046 045242082384		
230	2.5	10	-	4 - 10	Ø 10 - 160	4 - 10	4 - 10	Yes	Yes	5 50	1 1	48004713 48018713	045242081080 045242253555		
300	2.5	10	-	4 - 10	Ø 10 - 180	4 - 10	4 - 10	Yes	Yes	5	1	48005714	045242222810		

Metal: THIN KERF blades



DOUBLE DUTY UPGRADE



Improved tooth geometry for best speed and double the lifetime. Bi-Metal quality cutting teeth with 8% Cobalt the ultimate in performance and lifetime.



Stamped indentations around the reception strengthens the blade at its weakest point.

THIN KERF













Slim 0.90 mm thick blade body optimised for maximum speed and flexibility.



Unique cryogenic heat treatment process gives:
 – tougher teeth for cutting the hardest of metals
 – up to 50% longer life vs. standard Bi Metal blades



Metal: THIN KERF blades

Blade length (mm)	Tooth pitch (mm)	Teeth per inch	Ref. No.								Pack quantity	Min. order quantity	Article Number	EAN Code	
	100	1	24	S522AF	0.5 - 3	0.5 - 3	Ø 8 - 50	0.5 - 3	0.5 - 3	No	No	5	1	48005185	045242082865
	150	1	24	S922AF	0.5 - 3	0.5 - 3	Ø 8 - 100	0.5 - 3	0.5 - 3	No	No	5	1	48005186	045242082872
	100	1.4	18	S522EF	1.5 - 4	1.5 - 4	Ø 10 - 50	1.5 - 4	1.5 - 4	No	No	5	1	48005183	045242082841
	150	1.4	18	S922EF	1.5 - 4	1.5 - 4	Ø 10 - 100	1.5 - 4	1.5 - 4	No	No	5	1	48005184	045242082858
												50	1	48016184	045242084739
	150	1.4	18	S922EF	1.5 - 4	1.5 - 4	Ø 10 - 100	1.5 - 4	1.5 - 4	No	No	5	1	48004184	045242081042
	230	1.4	18	S1122EF	1.5 - 4	1.5 - 4	Ø 10 - 100	1.5 - 4	1.5 - 4	No	No	5	1	48005188	045242082896
												50	1	48016188	045242084876
	230	1.4	18	S1122EF	1.5 - 4	1.5 - 4	Ø 10 - 160	1.5 - 4	1.5 - 4	No	No	5	1	48004188	045242081066
	300	1.4	18	-	1.5 - 4	1.5 - 4	Ø 10 - 180	1.5 - 4	1.5 - 4	No	Yes	5	1	48005189	045242082902
												50	1	48016189	045242084883
	90	1.8	14	S422BF	1.5 - 6	1.5 - 6	-	1.5 - 4	-	Yes	No	5	1	48005162	045242082803
	100	1.8	14	S522BF	3 - 10	-	Ø 10 - 50	3 - 10	2 - 4	No	No	5	1	48005181	045242082827
	150	1.8	14	S922BF	3 - 10	-	Ø 10 - 100	3 - 10	2 - 4	No	No	5	1	48005182	045242082834
												50	1	48016182	045242084722
	150	1.8	14	S922BF	3 - 10	-	Ø 10 - 100	3 - 10	2 - 4	No	No	5	1	48004182	045242081035
	230	1.8	14	S1122BF	3 - 10	-	Ø 10 - 160	3 - 10	2 - 4	No	No	5	1	48005187	045242082889
												50	1	48016187	045242084869
	230	1.8	14	S1122BF	3 - 10	-	Ø 10 - 160	3 - 10	2 - 4	No	No	5	1	48004187	045242080991

Wood and plastics

Blade length (mm)	Tooth pitch (mm)	Teeth per inch	Ref. No.						Pack quantity	Min. order quantity	Article Number	EAN Code			
	150	4.2	6	S644D	6 - 100	-	6 - 100	No	Yes	3	1	48001075	045242079810		
	150	4.2	6	S744D	6-50	-	6-50	Yes	No	3	1	48001076	045242079827		
	230	4.2	6	-	6 - 190	6 - 190	6 - 100	No	Yes	5	1	48005016	045242082636		
	240	5.5/6	4/5	S1531L	15 - 190	15 - 190	-	No	No	3	1	48001077	045242079834		
	240	8.5	3	S1542K	15 - 190	-	-	No	No	3	1	48001078	045242079841		
	275	4.2	6	-	6 - 200	6 - 200	-	No	No	2	1	4932471693	4058546295929		
	300	4.2	6	S1344D	6 - 250	-	-	No	No	3	1	48001079	045242079858		

SAWZALL[™] blades for special materials

Special application: Ductwork blade

Plunge tip - fast plunging in materials < 0.6 mm. No need for extra tools.
 Versatility - tapered blade body profile allows for tight radius cutting and square cuts.
 Longlife - optimized tooth geometry 30 tpi for cutting thin material 0.6 - 1.5 mm. Most common spiral duct is 0.8 mm thick.



Blade length (mm)	Tooth pitch (mm)	Teeth per inch	Pack quantity	Min. order quantity	Article Number	EAN Code		
85	0.8	30	5	1	48001630	045242300174		











Special application: Drywall / plasterboard blade







Precise depth of cut - only 63 mm long, protects from unintentional cuts in pipes or wiring.
 Double sided teeth - cuts in ALL directions - produces less dust than jobsaw handtool - cuts clean without ripping the drywall.
 Plunge tip - fast and effortless plunging.

Blade length (mm)	Tooth pitch (mm)	Teeth per inch			Pack quantity	Min. order quantity	Article Number	EAN Code			
63	-	-	Yes	Yes	1	1	48001640	045242300181			
	125	4.2	6	Yes	Yes	5	1	48005052	045242082735		



Special application: Cast iron / abrasive materials / fibreglass

Blade length (mm)	Tooth pitch (mm)	Teeth per inch	Ref. No.						Pack quantity	Min. order quantity	Article Number	EAN Code	
	230	Coarse grit	-	Ø 10 - 160	Ø 10 - 160	3 - 175	-	-	1	1	48001450	045242187416	
	150	Coarse grit	-	Ø 10 - 100	Ø 10 - 100	3 - 100	-	-	3	1	48001420	045242081950	
	230	Coarse grit	S1130R	Ø 10 - 160	Ø 10 - 160	3 - 175	-	-	3	1	48001430	045242082001	
	305	8.5	3	S1241HM	-	-	6 - 150	10 - 250	-	1	1	48001080	045242079865
	450	17.0	1.5	-	-	-	6 - 150	10 - 350	10 - 350	1	1	48001460	045242235353

Special application: Insulation material / carton / foam

Blade length (mm)	Tooth pitch (mm)	Teeth per inch	Ref. No.					Pack quantity	Min. order quantity	Article Number	EAN Code	
	300	Wave knife	Wave knife	-	Yes	Yes	Yes	Yes	1	1	48001084	045242079902

Special application: Frozen materials

	300	4.2	6	S1211K					1	1	48001082	045242079889
	400	4.2	6	-					1	1	48001083	045242079896

Special Application: Flush cut blade



Flush cuts against floor - floor guard protects teeth from floor contact when cutting flush to the floor.
 Extra tall blade body - guides blade for straighter cuts ie. when cutting out doors and windows in wood construction.
 FANG TIP™ - for easy and quick plunging.
 Suitable for cutting all types of wood and nail embedded wood. Not suitable for brick, masonry or steel.

	Blade length (mm)	300	Tooth pitch (mm)	5	Teeth per inch	5	Ref. No.	-	Pack quantity	1	Min. order quantity	1	Article Number	48001600	EAN Code	045242253272
---	-------------------	-----	------------------	---	----------------	---	----------	---	---------------	---	---------------------	---	----------------	----------	----------	--------------

SAWZALL™ blade sets

Description	Pack quantity	Min. order quantity	Article Number	EAN Code	
SAWZALL™ blade set (5pc)					①
① 1 x AX™ wood with nails - 230 mm, 1 x WRECKER™ multi material - 230 mm, 1 x TORCH™ metal - 230 mm, 1 x TORCH™ metal - 150 mm, 1 x TORCH™ metal - 150 mm	5	1	49222205	045242536528	
SAWZALL™ carbide demolition blades set (5pc)					②
② Wood with nails: 2 x AX™ carbide - 230 mm. Metal: 2 x TORCH™ carbide - 150 mm, 1 x TORCH™ carbide - 230 mm	5	1	49222206	045242567492	
SAWZALL™ blade set (10pc)					③
③ 3 x THIN KERF metal - 150 mm, 3 x THIN KERF metal - 150 mm, 2 x THIN KERF wood with nails - 150 mm, 1 x THIN KERF wood with nails - 230 mm, 1 x THIN KERF metal - 230 mm	10	1	49222211	045242536856	
SAWZALL™ blade set (12pc)					④
④ 2 x AX™ wood with nails - 150 mm, 2 x AX™ wood with nails - 230 mm, 4 x TORCH™ metal - 150 mm, 2 x TORCH™ metal - 230 mm, 2 x WRECKER™ multi material - 150 mm	12	1	49222229	045242536863	
SAWZALL™ blade set (13pc)					⑤
⑤ 2 x WRECKER™ multi material - 150 mm, 2 x AX™ wood with nails - 150 mm, 2 x AX™ wood with nails - 230 mm, 4 x TORCH™ metal - 150 mm, 2 x TORCH™ metal - 230 mm, 1 x TORCH™ carbide - 150 mm	13	1	49222231	045242540686	

System accessories - SAWZALL™

Description	Fits SAWZALL™	Pack quantity	Min. order quantity	Article Number	EAN Code
Conversion kit: to convert FIXTEC blade reception models to keyed blade reception to accept 20 mm reception blades	SSE 1000 QX, SSPE 1000 QX, SSH 800 QX Hatchet, PSH 18v hatchet, V18 SX, SSPE 1300 QX, M18 FUEL™ SAWZALL™, USE 980 X, V28 SX, SSPE 1500 X	1	1	42680685	
Clamp		1	1	06832976	
Screw		1	1	06832976	
Allen key 5/32"		1	1	49960070	045242221554
Conversion kit: to convert FIXTEC blade reception models to keyed blade reception to accept 1/2" universal reception blades	SSE 1000 QX, SSPE 1000 QX, SSH 800 QX Hatchet, PSH 18v hatchet, V18 SX, SSPE 1300 QX, M18 FUEL™ SAWZALL™, USE 980 X, V28 SX, SSPE 1500 X	1	1	49225016	045242182060
Clamp		1	1	06832976	
Screw		1	1	06832976	
Allen key 5/32"		1	1	49960070	045242221554
Transport case for sabre saws / SAWZALL™	V18 SX, V28 SX	1	1	201602001	4002395836383
Cases supplied with latches and foam insert. Size 1 (L x W x H) 475 x 358 x 132 mm	PSH 18v hatchet	1	1	4932453385	4002395146376















HACKZALL™ blades

Especially engineered blades for exclusive use on 12 V HACKZALL™.

Bi-Metal construction for increased tooth durability.

Optimised tooth form for aggressive and faster cutting.

Thinner blade body for better speed of cut and up to 35% more cuts per charge vs. standard Bi Metal blades.

Blade length (mm)	Tooth pitch (mm)	Teeth per inch								Pack quantity	Min. order quantity	Article Number	EAN Code			
	100	4.2	6	-	-	-	-	6 - 40	Ø 10 - 40	5	1	49005460	045242160273			
	150	1.8	14	3 - 6	Ø 10 - 32	3 - 6	3 - 6	-	Ø 10 - 50	5	1	49005614	045242160334			
	100	1.4	18	1.5 - 4	Ø 10 - 32	1.5 - 4	-	-	-	5	1	49005418	045242160341			
	100	1	25	0.5 - 3	Ø 8 - 32	0.5 - 3	-	-	-	5	1	49005424	045242160358			
	75	-	-	-	-	-	-	-	-	1	1	49005456	045242219476			
75 mm scraper: for removing strong adhesive silicon, caulk, paint and rust.																
	125	-	-	-	-	-	-	-	-	1	1	49005455	045242293421			
125 mm wide scraper: for removing glue, silicon, caulk, vinyl, rust, paint and wallpaper.																
	60	-	-	-	-	-	-	-	-	1	1	49005450	045242221066			
Grout removal blade: for removing damaged or moulded grout between tiles.																
	HACKZALL™ blade set (10 pc)										10	1	49220220	045242160365		
2 x 49005460, 3 x 49005614, 3 x 49005424, 2 x 49005418																

Jigsaw blades

Material qualities

HCS

- High Carbon Steel jigsaw blades are used for cutting all types of wood and plastics.

HSS

- High Speed Steel blades are suited to cutting metal, non ferrous metal and aluminium.

Carbide grit

- These blades have a tungsten carbide grit edge making them suitable for abrasive materials.

TC

- Blades with tungsten carbide tipped teeth are ideally suited to glassfibre reinforced products. Those blades with a continuous tungsten carbide tooth strip cutting edge are suitable for extremely hard materials such as stainless steel.

Bi-Metal

- Bi-Metal blades consist of high speed steel teeth electron beam welded onto a flexible alloy steel back. These blades offer maximum performance in the most demanding applications in both wood and metal.

Bi-Metal blades offer the following benefits:

- Flexible and shatter resistant
- Longer lifetime. Metal cutting blades offer double the lifetime and wood cutting blades more than 5 times the lifetime over conventional HCS and HSS blades.
- High wear rate and heat resistance ensure the teeth stay sharp longer.
- Faster cutting performance.

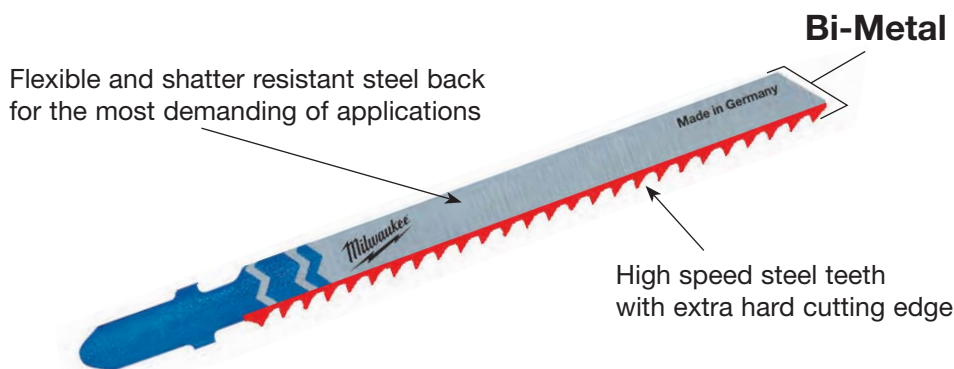

Blade colour code

Shank colour means application



= For all types of wood, laminated chipboard, chipboard, plywood, blockboard and plastics. Silver colour blade body.



= For all types of ferrous and non-ferrous metals, steel, aluminium, brass, copper, stainless steel, lead, tin and sandwich materials. Silver colour blade body.



= For cutting a range of products, carton, rubber, fibreglass, foam and abrasive materials. Black colour blade body.



= Bi-Metal blades come with a white body and then the corresponding colour shank; yellow for wood and blue for metal.

Shank receptions

T-Shank blades

- Suitable for most major brands.
AEG, Bosch, DeWalt, Festool, Hitachi, Hilti, Mafell, Makita, Metabo, MILWAUKEE®, Ryobi.



Special shank blades

- We do also offer a range of the most popular blades with either the Makita, or U-Shank reception.

U-Shank: for Black & Decker, Kress, Ryobi, Skil



Packaging

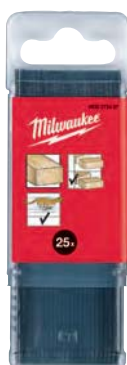

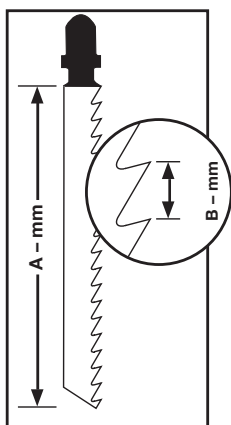

- Common blades are available in 5 and bulk 25 pack quantities. Our 25 pack packaging is reusable allowing for blades to be removed and returned easily.
- Our colour system on the blades is also featured on our packaging in conjunction with our pictograms to ensure you have the right blade for the application.

Technical tips

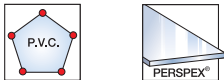

- The blade length represents the section of the blade with cutting teeth (A-mm). The tooth pitch is measured in millimetres (mm) from tooth point to tooth point (B-mm). Selecting the correct tooth pitch is dependent on the thickness of material being cut. The golden rule is to have three teeth in contact with the material being cut at all times; this is the optimum, as a guidance for thick material such as metals over 4 mm thickness a tooth pitch of 2 mm or more is recommended. For metals with a thickness of 1.5–3.5 mm a tooth pitch of 1.2 to 1.4 is desirable. When cutting thin metal sheet material below 1.5 mm a tooth pitch of 0.7 to 1.2 mm is recommended. The general rule when cutting wood is the higher the tooth pitch the faster and rougher/coarser the cut will be.
- When cutting extremely thin sheet material it is recommended to place the material onto a thicker backing to prevent the sheet material from breaking.
- We recommend the use of a cooling lubricant to extend the life of the saw blade when cutting metals and plastics.

Material	Coolant
	Cutting oil
	Turpentine
	Water

Jigsaw blades for wood and plastic



Traditional blades

Traditional blades that deliver good and solid performance.

Blade length (mm)	Tooth pitch (mm)	Ref. No.									Pack quantity	Min. order quantity	Article Number	EAN Code	
50	2	T 119 B	< 20	-	< 20	Yes	-	No	No	No	5	1	4932274353	4002395301553	
75	3	T 111 C	5 - 50	-	< 40	-	Yes	No	No	No	5	1	4932254071	4002395301539	

Curve cutting blades

All of our curve cutting blades are characterised by a narrow blade body for improved manoeuvrability.

Jigsaw blade 4932265312 and 4932430143 has cutting teeth on both sides.

The teeth on the back of the blade allows one to cut tight and acute curves with simplicity.

For best results work without pendulum action when cutting tight curves.

50	1.35	T 101 A0	< 20	< 20	< 15	Yes	No	Yes	No	No	5	1	4932373392	4002395348879	
50	2	T 119 B0	< 20	-	< 20	Yes	No	Yes	No	No	5	1	4932274650	4002395301485	
75	2.5	Curve	< 30	< 20	< 20	Yes	No	Yes	No	Yes	5	1	4932430143	4002395378043	
75	4 / 1.2	Special	< 30	-	< 30	No	Yes	Yes	No	No	5	1	4932265312	4002395301478	
75	4	T 244 D	< 50	-	-	No	Yes	Yes	No	Yes	5	1	4932346078	4002395312375	
											25	1	4932373492	4002395349920	

Fast cut blades

The sharp and aggressive tooth geometry is ideal for very fast cutting of wood.

75	4	T 144 D	< 50	-	-	No	Yes	No	No	Yes	5	1	4932213116	4002395301492	
											25	1	4932373487	4002395349272	
											100	1	4932430461	4002395381227	
Bi-Metal	75	4	T 144 DF	< 50	-	-	No	Yes	No	No	Yes	1	4932373391	4002395348862	
105	4	T 344 D	< 80	-	-	No	Yes	No	No	Yes	5	1	4932311633	4002395301508	
155	4	T 744 D	5-125	-	-	No	Yes	No	No	Yes	5	1	4932354745	4002395324095	

Fast and clean cutting blades

Triple sharpened tooth geometry for fast and super clean splinter free cuts. Plunge tip for fast plunging.

Blade length (mm)	Tooth pitch (mm)	Ref. No.										Pack quantity	Min. order quantity	Article Number	EAN Code	
4301 41																
91	2.5	T 234 X	3 - 60	3 - 60	Yes	< 45	No	No	Yes	No	5	1	4932430141	4002395378029		

3 cut

Clean and splinter free cutting blades

The following blades have diagonally sharpened side teeth resulting in a very clear splinter free cut.

2540 61																
75	2.5	T 101 B	< 30	< 60	No	< 30	Yes	No	No	No	5	1	4932254061	4002395301522		
											25	1	4932373489	4002395349296		
3733 90																
75	2.5	T 101 BF	< 30	< 60	No	< 30	Yes	No	No	No	5	1	4932373390	4002395348855		
2743 51																
75	4	T 101 D	< 50	< 60	No	< 45	Yes	No	No	No	5	1	4932274351	4002395301515		
											25	1	4932373490	4002395349906		
3993 06																
105	3	T 301 CD	< 80	< 60	No	-	Yes	No	No	No	5	1	4932399306	4002395359202		
105	4	T 301 DL	< 80	< 80	No	< 50	Yes	No	No	No	5	1	4932346071	4002395312399		
3460 71																

Bi-Metal

Precise straight cutting blades: Kitchen worktops

The following blades benefit from a thicker blade body guaranteeing extra stiffness and consequently a more accurate vertical cut. Ideal for those applications where a true square cut is necessary - i.e. kitchen worktops.

3730 80																
75	4	T 101 DP	< 60	< 60	No	< 45	Yes	No	No	Yes	5	1	4932373080	4002395346073		
3733 88																
105	4	T 101 DP sp.	< 80	< 80	No	< 50	Yes	No	No	Yes	5	1	4932373388	4002395348831		

Special application: Kitchen worktops / laminated chipboard

These blades have a reversed tooth design, this means that the blade cuts on the downward stroke making them extremely suitable for clean and splinter free cuts in laminated chipboard and especially kitchen worktops in situ.

For best results work without pendulum action.

3460 79																
75	2.5	T 101 BR	< 30	< 60	No	< 60	Yes	No	No	No	5	1	4932346079	4002395312382		
3480 72																
105	2.5	T101BR sp.	< 50	< 80	No	< 80	Yes	No	No	No	5	1	4932348072	4002395313860		

Special application: Laminated flooring / parquet flooring

Blade 4932373392 is ideally suited for cutting curves and irregular shapes. Use blade 4932373083 for straight cuts.

3733 92																
50	1.35	T 101 A0	< 20	No	< 20	< 15	Yes	No	Yes	No	5	1	4932373392	4002395348879		
3730 83																
60	1.9	Special	3 - 20	Yes	Yes	-	Yes	No	No	No	5	1	4932373083	4002395346080		

Jigsaw blades for metal



Traditional blades

Blade reference 4939274652 is especially suited to cutting very thin sheet material because of its low 0.7 mm tooth pitch. For those professionals desiring extra lifetime and durability we recommend the use of Bi-Metal blades in conjunction with a suitable cooling lubricant, the blades lifetime is double that of non Bi-Metal blades.

Blade length (mm)	Tooth pitch (mm)	Ref. No.	METAL	Cu/Ni/Ms/Zn	SPRINKLES-ROCK NIKOSITA	ALU	P.W.G.	PERSPEX	Pack quantity	Min. order quantity	Article Number	EAN Code	
2746 52 Made in Germany													
55	0.7	T 118 G	0.5 - 2	0.5 - 2	-	-	-	-	No	5	1	4932274652 4002395301621	
2540 63 Made in Germany													
55	1.2	T 118 A	1.5 - 4	1.5 - 4	-	-	-	-	No	5	1	4932254063 4002395301614	
3400 11 BI-METAL Made in Germany													
Bi-Metal 55	1.2	T 118 AF	1.5 - 4	1.5 - 4	-	1.2 - 2	-	-	No	5	1	4932340011 4002395304684	
3458 26 Made in Germany													
66	1.2	T 118 A sp.	1.5 - 4	1.5 - 4	-	-	-	-	No	5	1	4932345826 4002395313464	
3993 07 Made in Germany													
105	1	T 318 A	1 - 4	1 - 4	< 85	-	-	-	No	5	1	4932399307 4002395359219	
2540 64 Made in Germany													
55	2	T 118 B	3 - 6	3 - 6	-	-	3 - 10	-	No	5	1	4932254064 4002395301591	
3400 12 BI-METAL Made in Germany													
Bi-Metal 55	2	T 118 BF	3 - 6	3 - 6	-	2 - 3	3 - 10	-	2 - 30	No	5	1	4932340012 4002395304691
2746 51 BI-METAL Made in Germany													
Bi-Metal 75	2.5	T 101 A sp.	-	2 - 10	< 45	-	3 - 10	-	2 - 20	No	5	1	4932274651 4002395301577

TID-extra
Industrial Technologies d.o.o.

Universal application blades

These blades are suitable for cutting a wide variety of materials ranging from mild steel, aluminium, wood with nails, plastics and sandwich composites. Blade 4932373086 with its extra length (155 mm) is suitable for cutting thick corrugated sandwich material.

4301 42 BI-METAL TWIN-CUT Made in Germany													
Bi-Metal TWIN CUT 91	2.5 / 1.8	T 123 XF	2.5 - 10	3 - 10	< 50	-	4 - 10	-	-	No	5	1	4932430142 4002395378036
2746 54 BI-METAL Made in Germany													
Bi-Metal 105	1.2	T 318 AF	1.5 - 4	1.5 - 4	< 85	-	-	-	-	No	5	1	4932274654 4002395301607
2746 53 BI-METAL Made in Germany													
Bi-Metal 105	2	T 318 BF	3 - 6	3 - 6	< 85	-	3 - 10	4 - 30	-	No	5	1	4932274653 4002395301584
3730 86 BI-METAL Made in Germany													
Bi-Metal 155	1	T 718 AF	1 - 4	1 - 4	< 125	-	-	-	-	No	5	1	4932373086 4002395346097

Curve cutting blades

Especially narrower saw blade body allows one to cut tight curves in a range of metallic materials.

3460 82 Made in Germany													
55	1.2	T 218 A	1.5 - 4	1.5 - 4	-	-	-	-	-	Yes	5	1	4932346082 4002395312368
3460 81 Made in Germany													
75	3	T 227 D	3.5 - 6	3.5 - 6	-	-	4 - 15	4 - 30	-	Yes	5	1	4932346081 4002395312351

Special application: Aluminium

Most traditional blades are also capable of cutting aluminium, however these two blades benefit from a larger tooth pitch and wider gullets offering better material removal which is an advantage when cutting aluminium.

When cutting curves or irregular shapes in aluminium we recommend the use of blade 4932346081.

Blade length (mm)	Tooth pitch (mm)	Ref. No.	METAL	Cu/Ni/Ms/Zn		STAINLESS-STEEL INOXSTA	ALU	P.V.C.	Pack quantity	Min. order quantity	Article Number	EAN Code
75	3	T 127 D	3.5 - 6	3.5 - 6	-	-	4 - 15	4 - 30	5	1	4932274315	4002395301560

Special application: Stainless steel

This blades teeth consist of a carbide tipped strip making it the most suitable and durable blade for steels with a high alloy content such as stainless steel.

For best results work without pendulum action and use cutting oil as a lubricant.

50	1.1	T 118 AHM	1.5 - 3	1.5 - 3	-	1.5 - 3	-	-	2	1	4932373393	4002395348886
50	1.4	T 118 EHM	2 - 5	2 - 5	-	2 - 5	-	-	2	1	4932373394	4002395348893

Jigsaw blades for special materials

Special applications: Fibreglass / reinforced plastics / acrylic glass

Blade 4932373387 has tungsten carbide teeth for longer lifetime in hard materials such as fibreglass.

Blade length (mm)	Tooth pitch (mm)	Ref. No.	Cu/Ni/Ms/Zn		P.V.C.	PERSPEX					Pack quantity	Min. order quantity	Article Number	EAN Code		
75	2.5	T 101 A sp.	2 - 10	-	No	No	-	2 - 20	-	No	-	No	5	1	4932274651	4002395301577
75	4.2	T 141 HM	-	-	No	No	5 - 20	-	5 - 20	No	-	Yes	1	1	4932399308	4002395359226
105	4.2	T 341 HM	-	< 60	No	No	5 - 20	-	5 - 20	No	-	No	1	1	4932373387	4002395348824

Special application: Abrasive materials / cast iron

54	Grain 30	T 130 Coarse grit	-	-	Yes	Yes	< 15	-	-	Yes	5 - 15	No	1	1	4932213231	4002395301645
54	Grain 50	T 150 Fine	-	-	Yes	Yes	< 10	-	-	Yes	5 - 15	No	1	1	4932213232	4002395301652

Special application: Insulation material

Blade length (mm)	Tooth pitch (mm)	Ref. No.		Pack quantity	Min. order quantity	Article Number	EAN Code
155	Wave knife	T 313 AW	Yes Yes Yes Yes	5	1	4932430144	4002395378050

Jigsaw blade sets - T-Shank reception

Description	Pack quantity	Min. order quantity	Article Number	EAN Code
Jigsaw blades set (5pc) - suitable for applications in wood and metal	5	1	4932345825	4002395314850
Jigsaw blade 4932213116, 4932254061, 4932254063, 4932254064, 4932254071				



TiD-extra
Industrial Technologies d.o.o.

System accessories - Jigsaws

Description	Pack quantity	Min. order quantity	Article Number	EAN Code
HD18 JS/JSB BST 18 X Li JS 120 x JSPE 135 TX STEP 1200 BX/X JSPE 90 X FSPE 11 X BSPE 110 QX STEP 800 X ST 800 XE V28 JSB	1	1	4932430356	4002395380176
STEP 70 STEP 75 ST 700 E STEP 90 X STEP 100 X FSPE 100 XL BSPE 100 XL	1	1	4932430834	4002395384969

① Gliding shoe for materials with delicate surfaces

①



U-Shank jigsaw blades

Blade length (mm)	Tooth pitch (mm)	Ref. No.							Pack quantity	Min. order quantity	Article Number	EAN Code
75	4	A 2202	5 - 60	< 60	-	No	Yes	Yes	5	1	4932354508	4002395321070
75	2.5	A5035/A5041	< 30	< 60	< 30	Yes	No	No	5	1	4932354506	4002395321056

STARLOCK

OSCILLATING MULTI-TOOL BLADES

NO COMPONENTS OR ADAPTORS REQUIRED

FAST BLADE CHANGES

100% POWER TRANSMISSION FROM TOOL TO ACCESSORY

ONE UNIVERSAL SYSTEM

WHY MILWAUKEE®?

- 1 **BEST LIFETIME & DURABILITY**
- 2 **ALL-TRADE FOCUSED SOLUTIONS**
- 3 **FULLY-STACKED COMPREHENSIVE RANGE**
- 4 **OVER 22 OMT PRODUCTS IN THE RANGE**





















CARBIDE EXTREME

Multi Material 35mm plunge cut carbide toothed blade for extra long-life (30X more life than standard blades).

48906040

30x MORE CUTS

CARBIDE EXTREME

Description	Soft Wood	Hard Wood	Plastic	Wood+Nails	Metal	Grout	Tile Adhesive	Pack quantity	ART.#
 Wood 35mm plunge cut blade.	✓		✓					1	48906001
 Wood 35mm plunge cut blade with 3 cut tooth geometry for fast and clean cuts.	✓	✓	✓					10	48906004
 Wood 65mm wide plunge cut blade.	✓		✓					1	48906005
 Wood 65mm wide plunge cut blade with 3 cut tooth geometry for fast and clean cuts.	✓	✓	✓					1	48906015
 Wood 35mm plunge cut Bi-Metal blade for long-life and 3 cut tooth geometry for fast and clean cuts.	✓	✓	✓					1	48906017
 Wood with nails 35mm plunge cut Bi-Metal blade for long-life.	✓		✓	✓				10	48906019
 Wood with nails 65mm plunge cut Bi-Metal blade for long-life.	✓		✓	✓				1	48906021
 Multi Material 28mm plunge cut Bi-Metal blade for long-life.	✓	✓	✓	✓	✓			10	48906024
 Multi Material 43mm plunge cut Bi-Metal blade for long-life.	✓	✓	✓	✓	✓			1	48906027
 Multi Material 35mm plunge cut carbide toothed blade for extra long-life (30X more life than standard blades).	✓	✓	✓	✓	✓			1	48906031
 Multi Material 85mm diameter segmented flush cut blade.	✓	✓	✓	✓	✓			1	48906033
 Multi Material 100mm diameter segmented flush cut Bi-Metal blade for long-life.	✓	✓	✓	✓	✓			1	48906034
 Grout removal 2.2mm thick carbide grit blade. For removing damaged grout between wall or floor tiles.						✓		1	48906035
 Grout removal 1.2mm thick carbide grit blade. For removing damaged grout between wall or floor tiles.						✓		1	48906040
 Grout removal 2.2mm thick diamond grit blade for extra long life. For removing damaged grout between wall or floor tiles. 5x more life than carbide grout blades.						✓		1	48906038
 Grout removal 1.2mm thick diamond grit blade for extra long life. For removing damaged grout between wall or floor tiles. 5x more life than carbide grout blades.						✓		1	48906051
 Rasp with carbide grit for rough sanding and smoothing of tile adhesive, mortar and wood.	✓						✓	1	48906053
 Firm scraper for removal of hard residues like hard adhesives, tile adhesives, concrete residues and old paint.							✓	1	48906052

SANDING

Sanding pad with 6 holes, hook and loop fixation.

48906070



Description	GRIT	Pack quantity	ART.#
Perforated sanding discs for wood, paint, lacquer and plaster 93x93x93mm.	60	6	48906071
	80	6	48906072
	120	6	48906073
	180	6	48906074
	220	6	48906075

Multi-Tool accessories - STARLOCK reception

NEW

STARLOCK universal blade reception makes MILWAUKEE® blades compatible with the most popular oscillating tools.

Description	Width (mm)	Length (mm)	Soft wood	Hard Wood	Plastics	Wood with Nails	Pack quantity	Min. order quantity	Article Number	EAN Code
① Wood 35 mm plunge cut blade	35	42	✓		✓		1 10	1 1	48906001 48906004	045242600298 045242600281
② Wood 35 mm plunge cut blade with 3 cut tooth geometry for fast and clean cuts	35	42	✓	✓	✓		1 10	1 1	48906011 48906014	045242600304 045242600311
③ Wood 65 mm wide plunge cut blade	65	42	✓		✓		1	1	48906005	045242600274
④ Wood 65 mm wide plunge cut blade with 3 cut tooth geometry for fast and clean cuts	65	42	✓	✓	✓		1	1	48906015	045242600328
⑤ Wood 35 mm plunge cut Bi-Metal blade for long life and 3 cut tooth geometry for fast and clean cuts	35	42	✓	✓	✓		1 10	1 1	48906017 48906019	045242600335 045242600342
⑥ Wood with nails 35 mm plunge cut Bi-Metal blade for long life	35	42	✓	✓	✓	✓	1 10	1 1	48906021 48906024	045242600359 045242600366
⑦ Wood with nails 65 mm plunge cut Bi-Metal blade for long life	65	42	✓	✓	✓	✓	1	1	48906027	045242600373
⑧ Multi Material 28 mm plunge cut Bi-Metal blade for long life	28	47	✓	✓	✓	✓	1 10	1 1	48906031 48906034	045242600380 045242600397
⑨ Multi Material 43 mm plunge cut Bi-Metal blade for long life	43	47	✓	✓	✓	✓	1	1	48906035	045242600403
⑩ Multi Material 35 mm plunge cut carbide toothed blade for extra long life (30x life than standard blades)	35	32	✓	✓	✓	✓	1	1	48906040	045242600458
⑪ Multi Material 85 mm diameter segmented flush cut blade	85	20	✓	✓	✓	✓	1	1	48906038	045242600410
⑫ Multi Material 100 mm diameter segmented flush cut Bi-Metal blade for long life	100	28	✓	✓	✓	✓	1	1	48906039	045242600427
⑬ Grout removal 2.2 mm carbide grit blade. For removing damaged grout between wall or floor tiles	75	20					1	1	48906051	045242600441
⑭ Grout removal 1.2 mm carbide grit blade. For removing damaged grout between wall or floor tiles	75	20					1	1	48906050	045242600434
⑮ Grout removal 2.2 mm diamond grit blade for extra long life. For removing damaged grout between wall or floor tiles	90	25					1	1	48906053	045242600489
⑯ Grout removal 1.2 mm diamond grit blade for extra long life. For removing damaged grout between wall or floor tiles	75	25					1	1	48906052	045242600465
⑰ Rasp with carbide grit for rough sanding and smoothing of tile adhesive, mortar and wood	80	80	✓				1	1	48906054	045242600496
⑱ Flexible scraper for removal of soft residues like silicone, acrylic, carpet adhesive and old paint	52	37					1	1	48906061	045242600540
⑲ Firm scraper for removal of hard residues like hard adhesives, tile adhesives, concrete residues and old paint	52	37					1	1	48906062	045242600557
⑳ Flexible cutter/scraper for silicone and soft window putty material	70	-					1	1	48906063	045242600564
㉑ Knife with 3 cutting edges. For cutting carpet, PVC flooring, cardboard and roofing felt	40	-					1	1	48906060	045242600519
㉒ Sanding pad 93 x 93 mm - Hook & Loop	93	93					1	1	48906070	045242600571
				Grit						
				60			6	1	48906071	045242600588
				80			6	1	48906072	045242600595
				120			6	1	48906073	045242600601
				180			6	1	48906074	045242600618
				240			6	1	48906075	045242600632
Renovation set (8pc)										
㉓ 2 x multi mat. 28mm plunge cut blade, 2 x multi mat. 43mm plunge cut blade, 1 x grout removal 2.2mm carbide blade, 1 x 3X cutting knife, 1 x rasp carbide grit, 1 x flexible scraper 52mm							8	1	48906088	045242600649
General multi-tool blade set (11pc)										
㉔ 2 x 35 mm plunge cut blade, 2 x 65 mm plunge cut blade, 1 x 65 mm 3C fast plunge cut blade, 2 x multi mat. 28 mm plunge cut blade, 2 x multi mat. 43 mm plunge cut blade, 1 x multi mat. 85 mm seg. flush cut blade, 1 x firm scraper 52 mm							11	1	48906090	045242600663





Nothing but **HEAVY DUTY.**[™]

CIRCULAR SAW BLADES

CUTS COOLER. INCREASED ACCURACY. LONGER LIFE.

TiD-extra
Industrijske tehnologije d.o.o.



CUTS COOLER
ANTI-FRICTION COATING



INCREASED ACCURACY
LASER CUT TECHNOLOGY

COBALT INFUSED TUNGSTEN CARBIDE TEETH
PRODUCE SHARP AND CLEAN CUTS



ALTERNATE TOOTH BEVEL



TRIPLE TOOTH CHIP AND FLAT FORM



DIAMOND FLAT TOOTH

Circular saw blades for hand held circular saws

PTFE coating: Cuts cooler, non stick for quicker cuts. Protects against corrosion and accumulation of resin.

Laser cut vibration slots: Low vibration and increased accuracy. Slots are filled with polyurethane and act as shock absorbers by isolating the teeth from vibration.

High grade laser cut steel: Guaranteed accuracy.

Premium cobalt infused tungsten carbide: Sharp and clean cuts.

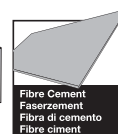
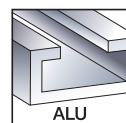
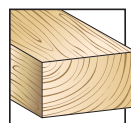

Blade diameter (mm)	Bore size (mm)	No. of teeth	Cutting width (kerf) (mm)	Hook Angle	Tooth Form	Thin Kerf*	All Wood Types*	Abrasive Particleboard, Fibre-cement Board, Fiberglass	Plastics	Non ferrous metals profiles alu	Fast cut	Clean Cut	Pack quantity	Min. order quantity	Article Number	EAN Code
140	20	18	1.6	+18°	ATB	✓	✓				✓		1	1	4932471310	4058546289386
		24	2.2	+15°	ATB		✓				✓		1	1	4932471290	4058546289188
	20	48	2.2	+5°	ATB		✓					✓	1	1	4932471291	4058546289195
		52	2.2	-5°	TF				✓	✓		✓	1	1	4932471292	4058546289201
160	20	4	2.2	+10°	D			✓			✓		1	1	4932471293	4058546289218
		24	1.6	+15°	ATB	✓	✓				✓		1	1	4932471311	4058546289393
		40	1.6	+18°	ATB	✓	✓					✓	1	1	4932471312	4058546289409
		24	1.6	+15°	ATB	✓	✓				✓		1	1	4932471931	4058546298302
165	20	40	1.6	+18°	ATB	✓	✓					✓	1	1	4932471932	4058546298319
		24	2.2	+15°	ATB		✓				✓		1	1	4932471294	4058546289225
		48	2.2	+5°	ATB		✓					✓	1	1	4932471295	4058546289232
		52	2.2	-5°	TF				✓	✓		✓	1	1	4932471296	4058546289249
165	30	24	1.8	+15°	ATB	✓	✓				✓	1	1	4932399909**	4002395365647	
184	5/8"	24	1.6	+15°	ATB	✓	✓				✓		1	1	4932471378	4058546290061
		40	2.1	+15°	ATB	✓	✓					✓	1	1	4932471379	4058546290078
184	30	24	1.6	+15°	ATB	✓	✓				✓		1	1	4932471297	4058546289256
		40	2.1	+10°	ATB	✓	✓					✓	1	1	4932471298	4058546289263
		54	2.4	-5°	TF				✓	✓		✓	1	1	4932471299	4058546289270
		24	1.6	+15°	ATB	✓	✓				✓		1	1	4932471300	4058546289287
190	30	36	1.6	+15°	ATB	✓	✓				✓		1	1	4932471301	4058546289294
		48	2.1	+10°	ATB	✓	✓					✓	1	1	4932471380	4058546290085
		54	2.4	-5°	TF				✓	✓		✓	1	1	4932471303	4058546289317
		4	1.8	+10°	D				✓			✓	1	1	4932471304	4058546289324
210	30	16	2.4	+15°	ATB	✓	✓				✓		1	1	4932471324	4058546289522
		48	2.8	+10°	ATB	✓	✓					✓	1	1	4932471325	4058546289539
		24	2.4	+15°	ATB		✓				✓		1	1	4932471305	4058546289331
		36	2.4	+15°	ATB		✓				✓		1	1	4932471306	4058546289348
235	30	48	2.4	+10°	ATB		✓					✓	1	1	4932471307	4058546289355
		60	2.4	+10°	ATB		✓					✓	1	1	4932471308	4058546289362
		60	2.4	-5°	TF				✓	✓		✓	1	1	4932471309	4058546289379

*Thin Kerf: Cordless optimised, extra thin cutting width for maximum runtime

*All wood types: Soft/ hardwood, plywood, laminated chipboard, melamine, MDF

**Standard blades without PTFE coating and vibration slots

Circular saw blades for mitre saws

PTFE coating: Cuts cooler, non stick for quicker cuts. Protects against corrosion and accumulation of resin.
 Laser cut vibration slots: Low vibration and increased accuracy. Slots are filled with polyurethane and act as shock absorbers by isolating the teeth from vibration.
 High grade laser cut steel: Guaranteed accuracy.
 Premium cobalt infused tungsten carbide: Sharp and clean cuts.



Blade diameter (mm)	Bore size (mm)	No. of teeth	Cutting width (kerf) (mm)	Hook Angle	Tooth Form	Thin Kerf*	All Wood Types*	Abrasive Particle-board, Fibre-cement Board, Fiber-glass*	Plastics	Non ferrous metals profiles alu	Fast cut	Clean Cut	Pack quantity	Min. order quantity	Article Number	EAN Code
190	30	40	2.4	-5°	ATB	✓	✓				✓		1	1	4932471314	4058546289423
		24	2.4	-5°	ATB		✓				✓		1	1	4932471315	4058546289430
		48	2.4	-5°	ATB		✓				✓		1	1	4932471316	4058546289447
216	30	60	2.4	-5°	ATB		✓					✓	1	1	4932471317	4058546289454
		80	2.4	-5°	TF				✓	✓		✓	1	1	4932471319	4058546289478
		40	2.8	+15°	ATB		✓				✓		1	1	4932472015	4058546324117
250	30	60	2.8	+15°	ATB		✓					✓	1	1	4932472016	4058546324124
		60	3.0	-5°	ATB		✓				✓		1	1	4932471320	4058546289485
254	30	80	3.0	-5°	TF				✓	✓		✓	1	1	4932471318	4058546289461
		60	3.0	-5°	ATB		✓				✓		1	1	4932471321	4058546289492
305	30	100	3.0	-5°	ATB		✓					✓	1	1	4932471322	4058546289508
		96	3.0	-5°	TF				✓	✓		✓	1	1	4932471323	4058546289515

*Thin Kerf: Cordless optimised, extra thin cutting width for maximum runtime
 *All wood types: Soft/ hardwood, plywood, laminated chipboard, melamine, MDF

Circular saw blades for table saws

PTFE coating: Cuts cooler, non stick for quicker cuts. Protects against corrosion and accumulation of resin.
 Laser cut vibration slots: Low vibration and increased accuracy. Slots are filled with polyurethane and act as shock absorbers by isolating the teeth from vibration.
 High grade laser cut steel: Guaranteed accuracy.
 Premium cobalt infused tungsten carbide: Sharp and clean cuts.

Blade diameter (mm)	Bore size (mm)	No. of teeth	Cutting width (kerf) (mm)	Hook Angle	Tooth Form	Thin Kerf*	All Wood Types*	Abrasive Particle-board, Fibre-cement Board, Fiber-glass*	Plastics	Non ferrous metals profiles alu	Fast cut	Clean Cut	Pack quantity	Min. order quantity	Article Number	EAN Code
210	30	24	1.9	+25°	ATB	✓	✓				✓		1	1	4932478095	4058546340285

*Thin Kerf: Cordless optimised, extra thin cutting width for maximum runtime
 *All wood types: Soft/ hardwood, plywood, laminated chipboard, melamine, MDF

Circular saw blades for metal

NEW

1. Engineered tooth geometry for optimum performance.
2. Top grade carbide and cermet tooth tips for superior lifetime.
3. Fully hardened and tensioned blade body for accurate cuts.
4. Deep gullets provide rapid and efficient chip removal.
5. Laser cut resin filled expansion slots for noise and vibration dampening.

- Cuts clean. Burr free edges reduce extra finishing processes.
- Cuts cool. The cut material can be handled immediately after cutting.
- Cuts fast. Quicker than all other conventional cutting methods.
- Cost cutter. Less expensive per cut than abrasive discs.
- Reduced noise.
- Reduced vibration.
- Total safety: no sparks, no coolants, cool to touch.

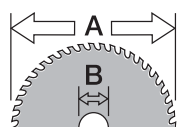

Ø mm

Blade diameter (mm)	Bore size (mm)	No. of teeth	Cutting width (kerf) (mm)	Material wall thickness (mm)	Mild steel	Sheet steel up to 2.5mm	Corrugated steel panels up to 2.5mm	Steel tube	Steel pipe	Angle iron	Steel channel	Stainless steel sheets	Cast iron	Copper	Aluminium	Rebar	Sandwich material (steel, foam, panels)	Article Number	EAN Code
135	20	30	1.6	1-2.5	✓	✓	✓	✓	✓	✓	✓	✦	✗	✗	✗	✗	✓	48404070	045242233786
		50	1.6	1-2.5	✗	✗	✗	✗	✗	✗	✗	✗	✗	✓	✓	✗	✦	48404075	045242233793
150	20	34	1.6	>2.5	✓	✓	✓	✓	✓	✓	✓	✦	✗	✗	✗	✗	✓	48404215	045242568994
165	5/8"	48	1.6	1-2.5	✓	✓	✓	✓	✓	✓	✓	✗	✗	✗	✗	✗	✓	48404220	045242569069
174	20	60	1.6	1-2.5	✓	✓	✓	✓	✓	✓	✓	✗	✗	✗	✗	✗	✗	48404225	045242569052
		42	1.8	>2.5	✓	✗	✗	✓	✓	✓	✓	✗	✗	✗	✗	✗	✗	✗	48404515
203	5/8"	50	1.8	1-2.5	✓	✓	✓	✓	✓	✓	✓	✦	✗	✗	✗	✗	✓	48404520	045242134472
		58	2.4	>2.5	✗	✗	✗	✗	✗	✗	✗	✗	✗	✓	✓	✗	✦	48404345	045242569113
		70	1.6	0.5-1.5	✓	✓	✓	✓	✓	✓	✓	✓	✦	✗	✗	✗	✓	✓	4932478815

✓ Most suitable. Recommended for these materials.

✦ Suitable. Recommended for intermittent use in these materials.

Very good cutting characteristics, but greatly reduced lifetime of the blade.

✗ Not suitable. Not recommended for these materials.

Optimising Blade Life

1. Clamp the workpiece securely to avoid vibration.
2. Do NOT stack or bundle cutting material. The gaps between layers allow for more opportunities to chip the teeth.
The life of the blade is severely affected by this type of cutting.
3. Lower the blade to its maximum cutting capacity and allow the tool to come to full speed before applying the blade to the material.
4. Do NOT force the saw blade into the material. Start gently, then gradually apply enough pressure to avoid sparks.
5. Optimal cutting speed and pressure will produce little or no sparks. Sparking creates heat build up which shortens saw blade life.
6. Keep the cut straight. If following a cut line and you wander off the line, getting back on line may cause side loading of the blade and break teeth. Use a edge guide whenever possible.
7. Do NOT apply side pressure on the blade as this will cause chipping of the teeth.
8. Periodically allow the tool to run free of the cutting material to cool the blade and tool especially when making long cuts or cuts in thick material.

Bandsaw blades

Choosing the right tooth geometry

8/10 Tpi Tooth pitch 2.3/1.8 mm	10 Tpi Tooth pitch 2.5 mm	12/14 Tpi Tooth pitch 1.8/1.4 mm	14 Tpi Tooth pitch 1.8 mm	18 Tpi Tooth pitch 1.4 mm	25 Tpi Tooth pitch 1 mm
FOR CUTTING STOCK 5 to 13 mm	FOR CUTTING STOCK 8 to 13 mm	FOR CUTTING STOCK 4 to 8 mm	FOR CUTTING STOCK 5 to 8 mm	FOR CUTTING STOCK 4 to 5 mm	FOR CUTTING STOCK < 4 mm



Premium Bi-Metal bandsaw blades

Multi pitch Bi-Metal blades with matrix II high speed steel teeth with 8% cobalt outlast conventional blades up to 3 times, requiring fewer blade changes.

Precision formed teeth create fast, clean cuts.

Optimised for cordless bandsaws: More cuts per charge.

Suitable for cutting: Angle iron, galvanised pipe and even tougher steels such as cast iron and stainless steel.



Premium bandsaw blade 1139.83 x 12.7 x 0.51 mm (Corded & M18 Deep Cut)

Material wall thickness (mm)	Tooth pitch (mm)	Teeth per inch	Pack quantity	Min. order quantity	Article Number	EAN Code
5 - 13	3.1 / 2.5	8 / 10	3	1	48390601	045242530298
			25	1	48390605	045242539697
4 - 8	2.1 / 1.8	12 / 14	3	1	48390611	045242530328
			25	1	48390615	045242539703



Premium bandsaw blade 898.52 x 12.7 x 0.51 mm (M18 Compact)

Material wall thickness (mm)	Tooth pitch (mm)	Teeth per inch	Pack quantity	Min. order quantity	Article Number	EAN Code
5 - 13	3.1 / 2.5	8 / 10	3	1	48390609	045242536412
			25	1	48390606	045242537754
4 - 8	2.1 / 1.8	12 / 14	3	1	48390619	045242536429
			25	1	48390616	045242537761



Premium bandsaw blade 687.57 x 12.7 x 0.51 mm (M12 Sub Compact)

Material wall thickness (mm)	Tooth pitch (mm)	Teeth per inch	Pack quantity	Min. order quantity	Article Number	EAN Code
4 - 8	2.1 / 1.8	12 / 14	3	1	48390711	045242536436



Premium bandsaw blade 776.29 x 12.7 x 0.51 mm (M12 Sub Compact)

Material wall thickness (mm)	Tooth pitch (mm)	Teeth per inch	Pack quantity	Min. order quantity	Article Number	EAN Code
4-8	2.1/1.8	12/14	3	1	48390631	045242605125
			25	1	48390636	045242605132
5-13	3.1/2.5	8/10	3	1	48390630	045242605156
			25	1	48390635	045242605163



Bi-Metal bandsaw blades

Suitable for cutting: Angle iron, galvanised pipe and even tougher steels such as cast iron and stainless steel.

Bandsaw blade 1139.83 x 12.7 x 0.51 mm (Corded & M18 FUEL™)

Material wall thickness (mm)	Tooth pitch (mm)	Teeth per inch	Pack quantity	Min. order quantity	Article Number	EAN Code
≥ 8	2.5	10	3	1	48390501	045242132096
5 - 8	1.8	14	3	1	48390511	045242132164
4 - 5	1.4	18	3	1	48390521	045242132263
≤ 4	1.0	25	3	1	48390531	045242132362



Bandsaw blade 898.52 x 12.7 x 0.51 mm (M18)

Material wall thickness (mm)	Tooth pitch (mm)	Teeth per inch	Pack quantity	Min. order quantity	Article Number	EAN Code
5 - 8	1.8	14	3	1	48390519	045242201594
4 - 5	1.4	18	3	1	48390529	045242201747
≤ 4	1.0	25	3	1	48390539	045242201815



Bandsaw blade 687.57 x 12.7 x 0.51 mm (M12)

Material wall thickness (mm)	Tooth pitch (mm)	Teeth per inch	Pack quantity	Min. order quantity	Article Number	EAN Code
2.5 - 8	1.4	18	3	1	48390572	045242272341





Nothing but **HEAVY DUTY.**[™]

SPEEDCROSS

MILWAUKEE® SPEEDCROSS DIAMOND BLADES ARE ENGINEERED FOR ALL CONSTRUCTION SITE PROFESSIONALS WHO DEMAND ONLY THE BEST IN PERFORMANCE WHEN WORKING IN THE TOUGHEST ENVIRONMENTS.



Segments

High diamond concentration with special aggressive geometry gives a high cutting performance. Laser welded segments for 100% user safety.

Precision engineered blade body

Pre-tensioned and hardened blade body for perfect concentration and maximum resistance to heat build up.

Cool cutting slots

The slots and holes improve the airflow keeping the cutting temperature of the segments to a minimum. This safeguards the segments from heat damage and allows the user to cut more and quicker.

Noise reduction qualities

Perfect balance and concentration suppress cutting noise.

Low vibration

The tensioned blade body eliminates wobble and minimises vibration.

TiD-extra
Electron Optics d.o.o.

Ø 150 x 22,23 mm
max. 12.700 rpm
max. 100 m/s
EN 13236
4932 3998 21



Milwaukee • 0 150 x 22,23 mm • max. 12.700 rpm • 100 m/s • WJ21Z

HUDD 150



**DIAMOND PREMIUM BLADES
MAXIMUM SPEED AND LIFETIME!**

Speedcross Blades

SPEED CROSS

**MAXIMUM SPEED,
LONG LIFE,
LOW VIBRATION!**

- Universal blades for a variety of materials
- Classed into two categories for maximum lifetime
- 10 mm segments height (STEELHEAD™: 4mm) to ensure long lifetime
- Laser welded segments for best performance
- Low vibration



**HUDD
HARD UNIVERSAL**



**AUDD
ABRASIVE UNIVERSAL**

Application areas

The Speedcross blades are both universal in application but their best performance is achieved at different ends of the spectrum. The HUDD is predominantly a blade for very hard to medium-hard general building materials, the harder the material the better the performance. Alternatively the AUDD is most suitable for hard materials to soft/abrasive materials, its best performance is achieved when used in standard hardness concrete and general building materials.

Hard materials

Soft/Abrasive materials

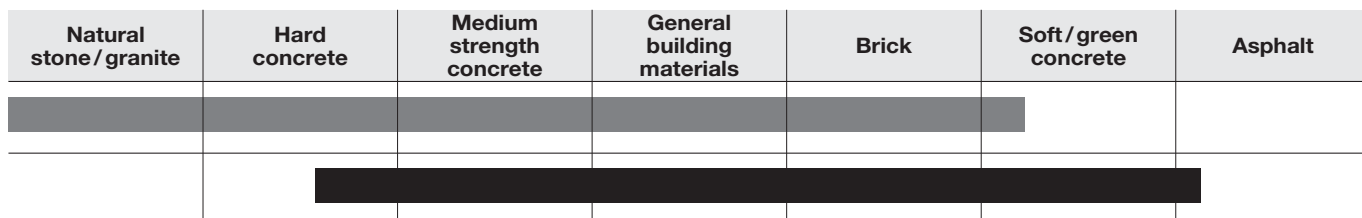

■ HUDD ■ AUDD

Speedcross diamond blades make the perfect match for the MX FUEL 350mm Cut Off Saw



Speedcross HUDD



Type	Disc diameter (mm)	Bore size (mm)	Segment height (mm)	Cutting width (mm)	Pack quantity	Min. order quantity	Article Number	EAN Code
HUDD 115	115	22.23	10	2.6	1	1	4932399819	4002395364749
HUDD 125	125	22.23	10	2.6	1	1	4932399820	4002395364756
HUDD 150	150	22.23	10	2.6	1	1	4932399821	4002395364763
HUDD 230	230	22.23	10	2.6	1	1	4932399822	4002395364770
HUDD 350*	350	25.4	8	2.6	1	1	4932471985	4058546298845

Speedcross AUDD



*For Speedcross AUDD 350mm only

Type	Disc diameter (mm)	Bore size (mm)	Segment height (mm)	Cutting width (mm)	Pack quantity	Min. order quantity	Article Number	EAN Code
AUDD 115	115	22.23	10	2.6	1	1	4932399823	4002395364787
AUDD 125	125	22.23	10	2.6	1	1	4932399824	4002395364794
AUDD 150	150	22.23	10	2.6	1	1	4932399825	4002395364800
AUDD 230	230	22.23	10	2.6	1	1	4932399826	4002395364817
AUDD 350*	350	25.4	10	2.6	1	1	4932471987	4058546298869

Speedcross STEELHEAD[™]

STEELHEAD[™] is most suitable for steel and stainless steel. Also suitable for heavily reinforced concrete

High density of special brazed diamonds ensure a very aggressive cutting progress

Due to the versatility and the outstanding performance the diamond disc is also perfect for fire brigades and for rescue operations

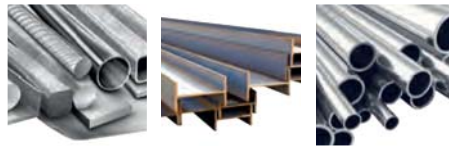

Type	Disc diameter (mm)	Bore size (mm)	Segment height (mm)	Cutting width (mm)	Pack quantity	Min. order quantity	Article Number	EAN Code
STEELHEAD [™] 350	350	25.4	4	2.8	1	1	4932471988	4058546298876

Speedcross DHMM

A brazed diamond disc designed for a wide range of applications.

Outstanding cutting performance due to extremely high diamond concentration.

Suitable for a vast variety of material like PVC, granite, tiles, hard artificial stone, composite material, drywall, thin wood, threaded rods and sheet metal.

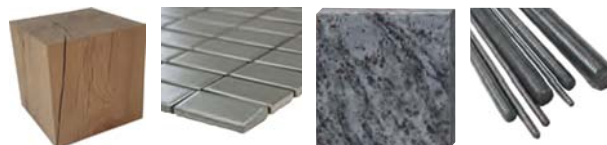

Type	Disc diameter (mm)	Bore size (mm)	Segment height (mm)	Cutting width (mm)	Pack quantity	Min. order quantity	Article Number	EAN Code
DHMM 76	76	10	2.2	1.2	1	1	4932471333	4058546289614

Diamond blades DUT

A general purpose turbo rimmed blade for cutting a wide variety of general building materials. The turbo rim ensures clean chip free cuts.



Type	Disc diameter (mm)	Bore size (mm)	Segment height (mm)	Cutting width (mm)	Pack quantity	Min. order quantity	Article Number	EAN Code
DUT 115	115	22.23	10	2.2	1	1	4932399526	4002395361731
DUT 125	125	22.23	10	2.3	1	1	4932399527	4002395361748
DUT 180	180	22.23	10	2.4	1	1	4932399528	4002395361755
DUT 230	230	22.23	10	2.6	1	1	4932399529	4002395361762

Diamond blades DUH

A trade laser welded quality blade with exceptional performance in hard materials such as hard concrete, block paviors and masonry products.



Type	Disc diameter (mm)	Bore size (mm)	Segment height (mm)	Cutting width (mm)	Pack quantity	Min. order quantity	Article Number	EAN Code
DUH 115	115	22.23	10	2.2	1	1	4932399539	4002395361861
DUH 125	125	22.23	10	2.3	1	1	4932399540	4002395361878
DUH 180	180	22.23	10	2.4	1	1	4932399541	4002395361885
DUH 230	230	22.23	10	2.6	1	1	4932399542	4002395361892
DUH 350*	350	25.4	10	2.8	1	1	4932471986	4058546298852

Diamond blades DHTS

A trade quality turbo blade with extra thin body for very fast, precise and chip free cuts in thin materials such as granite, marble slabs and tiles (type: porcelain, gres, ceramic).

Due to the high quality of this blade it is also suitable for cutting most building materials.

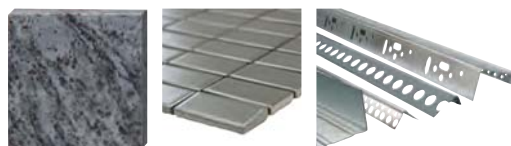

Type	Disc diameter (mm)	Bore size (mm)	Segment height (mm)	Cutting width (mm)	Pack quantity	Min. order quantity	Article Number	EAN Code
DHTS 76	76	10	5	1	1	1	4932464715	4058546226602
DHTS 115	115	22.23	10	1.2	1	1	4932399145	4002395357550
DHTS 125	125	22.23	10	1.2	1	1	4932399146	4002395357567
DHTS 230	230	22.23	10	1.9	1	1	4932399550	4002395361977

Diamond blades DHTi

Specifically designed turbo rimmed blade for clean cut edges in ceramic tiles and thin natural stone tiles / slabs.



Type	Disc diameter (mm)	Bore size (mm)	Segment height (mm)	Cutting width (mm)	Pack quantity	Min. order quantity	Article Number	EAN Code
DHTi 115	115	22.23	8	2.0	1	1	4932399552	4002395361991
DHTi 125	125	22.23	8	2.1	1	1	4932399553	4002395362004
DHTi 230	230	22.23	8	2.6	1	1	4932399555	4002395362028

Diamond blades DSU

A trade quality universal blade, specially designed for hard and abrasive materials.

Laser welded segments provide long lifetime and excellent cutting performance. Recommended for use with wall chasers.



Type	Disc diameter (mm)	Bore size (mm)	Segment height (mm)	Cutting width (mm)	Pack quantity	Min. order quantity	Article Number	EAN Code
DSU 125	125	22.23	10	2.4	1	1	4932373147	4002395346455
DSU 150	150	22.23	10	2.4	1	1	4932373148	4002395346462

Diamond blades DU

A general purpose blade offering good performance in speed and lifetime in a wide variety of construction materials.



Type	Disc diameter (mm)	Bore size (mm)	Segment height (mm)	Cutting width (mm)	Pack quantity	Min. order quantity	Article Number	EAN Code
DU 115	115	22.23	10	2.2	1	1	4932399521	4002395361687
DU 125	125	22.23	10	2.3	1	1	4932399522	4002395361694
DU 180	180	22.23	10	2.4	1	1	4932399523	4002395361700
DU 230	230	22.23	10	2.6	1	1	4932399524	4002395361717

Diamond blades: Which diamond cutting blade for which material?

Material	Type	Speedcross Premium			Professional					
		HUDD	AUDD	STEEL-HEAD™	DU	DUT	DUH	DHTS	DHTi	DSU
Abrasive refractory materials		◆	✓							
Aerated concrete/breeze blocks		◆	✓		✓	✓	✓			◆
Artificial stone		✓				✓	✓			✓
Artificial stone – hard		✓					✓	✓	◆	✓
Asphalt			◆							
Basalt		✓	✓			✓	✓			✓
Brick – very hard, engineering brick		✓				◆	✓			✓
Brick – medium to hard		✓			◆	◆	✓			✓
Brick – medium to soft		✓	✓		◆	◆	◆			✓
Concrete – hard		✓	◆	◆			✓			✓
Concrete – medium		✓	✓		✓	✓	✓			✓
Concrete – soft/green		◆	✓							◆
Concrete with flint aggregate		◆	✓							
Concrete with flint and rebar		◆	✓							
Concrete kerbstones		✓	✓	◆			✓			✓
Concrete lintels		✓	◆				✓			✓
Concrete block paviors		✓	✓		◆	◆	✓			✓
Concrete tiles		✓	✓		✓	✓	✓	◆		✓
Concrete reinforced with rebar		✓	◆	◆	◆	◆	✓			✓
Concrete slabs		✓	◆				✓			✓
Concrete slabs with aggregate		✓	✓			◆	✓			✓
Fireclay		✓	✓				✓			✓
General building materials		✓	✓	◆	✓	✓	✓			✓
Gneiss		✓					◆			◆
Granite		✓				✓	✓			✓
Granite tiles/slabs		◆				✓	◆	✓		◆
Lime/sandstone blocks – hard		✓	✓				✓			✓
Lime/sandstone blocks – medium		✓	✓		◆	◆	✓			
Lime/sandstone – soft/abrasive		◆	✓		◆	◆	◆			◆
Marble tiles/slabs		◆				✓	◆	✓	◆	✓
Metal channel/profiles								◆		
Poroton		✓	✓		✓	✓	✓			✓
Porphyry		✓				◆	✓	✓		✓
Roof tiles – clay		✓	◆		◆	✓	◆	✓		✓
Roof tiles – concrete		✓	✓			✓	◆	✓		✓
Screed		◆	✓		◆	◆	◆			◆
Slate		✓	◆		◆	✓	✓	✓		◆
Stoneware/clay tiles		✓	✓			✓	✓			✓
Tiles – ceramic						◆		✓	✓	
Tiles – porcelain and gres type						◆		✓	◆	
Tiles – terrazo type		✓	◆			✓	✓	✓		✓

✓ Most suitable. Recommended for these materials. Very long service life and very good cutting characteristics.

◆ Suitable. Recommended for intermittent use in these materials. Good service life and cutting characteristics.

Combi-segment diamond cup wheels

All rounder in applications:

For quick grinding down of thick concrete layers.

For levelling of concrete, granite and natural stone surfaces.

For edge grinding applications e.g. grinding off high edges of concrete, granite, natural stone tiles.

For roughening prior to covering with a new layer of coating.

High quality diamonds and special soft bonding for low wear, especially in hard materials.

Large openings for better dust removal and segment cooling.

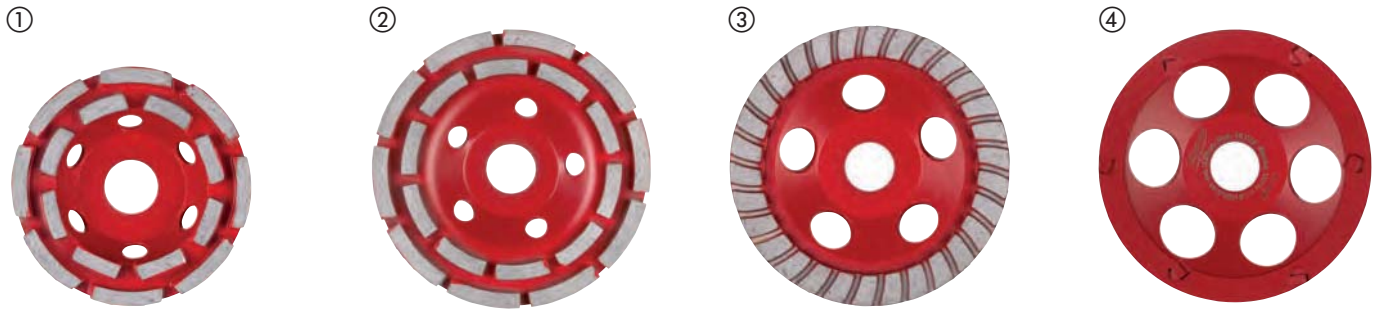

Type	Diameter (mm)	Bore size (mm)	No. of segments	Cup wheel height [mm]	Segment height (mm)	Pack quantity	Min. order quantity	Article Number	EAN Code
DCWU 100									
① Universal wheel for grinding and levelling applications. High stock removal	100	22.23	16	21	5	1	1	4932451185	4002395138739
DCWU 125									
② Universal wheel for grinding and levelling applications. High stock removal	125	22.23	20	21	5	1	1	4932451186	4002395138746
DCWUT 125									
③ Turbo type segment for levelling, edge grinding and for smooth finishing. Fine finish for concrete and natural stone	125	22.23	Turbo	21	5	1	1	4932451187	4002395138753
DCWS 125									
④ PCD segment for removal of special substances: thermoplastic and epoxy based coatings, acrylic paint, glue, tile adhesive, screed, plaster	125	22.23	6	18.5	4 / 7	1	1	4932451188	4002395138760

	DCWU 100	DCWU 125	DCWUT 125	DCWS 125
Acrylic paint and coatings				✓
Aerated and breeze concrete blocks	✓	✓	✓	
Bitumen				✓
Concrete hard	✓	✓	✓	
Concrete soft or green	◆	◆	◆	
Epoxy resin coatings and glues				✓
Granite	◆	◆	◆	
Lime and sandstone blocks hard	✓	✓	✓	
Lime and sandstone blocks soft and abrasive	◆	◆	◆	◆
Marble	◆	◆	◆	
Plasterboard	◆	◆	◆	
Porphyry	◆	◆	◆	
Screed	◆	◆	◆	
Thermoplastic protective paint, glue				✓
Tile adhesive	◆	◆	◆	✓

✓ Most suitable.

◆ Suitable - for intermittent use.

System accessories - Wall chasers

AUDD blade is a perfect solution for 80% of wall chaser applications.

- 30% less loading on the machine compared to the MILWAUKEE® DU blade.
- 40% higher speed of cut compared to the MILWAUKEE® DU blade.

SPEEDCROSS

	① HUDD	② AUDD	③ DSU
Abrasive refractory materials	◆	✓	
Aerated and breeze concrete blocks	◆	✓	◆
Brick medium to soft	✓	✓	✓
Concrete medium	✓	✓	✓
Concrete reinforced with rebar	✓	◆	✓
Concrete with flint and rebar	◆	✓	
Fireclay	✓	✓	✓
General building materials	✓	✓	✓
Granite	✓		✓
Lime and sandstone blocks soft and abrasive	◆	✓	◆
Lime and sandstone blocks medium	✓	✓	
Screed	◆	✓	◆

✓ Maximum performance ◆ Limited suitability - recommended for intermittent use



Description	Fits wall chasers	Pack quantity	Min. order quantity	Article Number	EAN Code
Transport case for wall chasers	MFE 1500, MFE 1305, MF 1900	WCE 30, WCS 45, DME 30, DME 45	1	1	4932383357 4002395357390
④ Two hole spanner straight	MFE 1500, MFE 1305, MF 1900	DME 30, DME 45, WCS 45, DME 65, WCE 65, WCE 30	1	1	4932367712 4002395338467
⑤ T-handle key	MFE 1500, MFE 1305, MF 1900	WCE 30, WCS 45, WCE 65, DME 30, DME 45, DME 65	1	1	4931362928 4002395661879
Dust protection grille against entry of ground particles	MFE 1500, MFE 1305, MF 1900	WCE 30, WCS 45, DME 30, DME 45	1	1	4932329397 4002395303892
⑥ Dust protection grille against entry of ground particles		WCE 65, DME 65	2	1	4932326525 4002395303311
Adaptor with bayonet fitting for direct connection of hose to machine	MFE 1500, MFE 1305, MF 1900	WCE 30, WCS 45, WCE 65, DME 30, DME 45, DME 65	1	1	4932362778 4002395334285
⑦ Side handle	MFE 1500, MFE 1305, MF 1900	WCE 30, WCS 45, DME 30, DME 45	1	1	4932409546 4002395370870
Flange nut	MFE 1305	DME 1300	1	1	4932334667 4002395304448
Clamping flange	MFE 1305	DME 1300	1	1	4932334706 4002395304455
Spacer set. Contents 6 rings	MFE 1305		6	1	4931334675 4002395762804

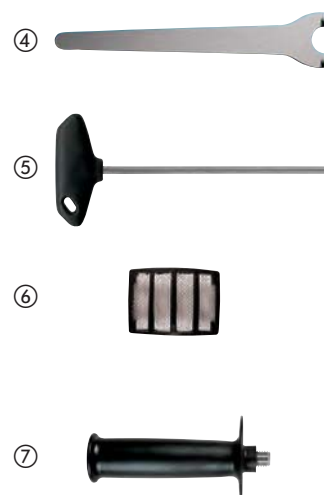

Cutting and grinding discs

MILWAUKEE® Type - how to find the right disc

SC 41 / 115

Material	Application	Design	Diameter	
S = Steel	C = Cutting	flat 41	mm	inches
C = Stone	G = Grinding	depressed 42	100	4
	CS = Cutting Slim	depressed 27	115	4½
	L = Flap	flap 50	125	5
	LC = Flap Ceramic		150	6
	CT = Cutting Thin		180	7
			230	9
			350	14



Extended life and moisture protection with PRO+**

■ Special mixture delivers:

Up to 20% longer lifetime vs. MILWAUKEE® contractor series.

Up to 20% less dust development vs. MILWAUKEE® contractor series.

The new formula HydroProtect prevents the age-related loss of performance and still provides almost the entire performance after months of storage.

■ Benefits:

Reduced costs per cut and shorter set up times.

Reduction of wheel deterioration during the storage interval.

Longer lasting high-performance.

**available on cutting and grinding discs with thickness 1, 1.5, 1.9 and 6 mm.

**+
20%
LIFETIME***

*vs. MILWAUKEE® contractor series



Thin metal cutting discs PRO+

Applications: Iron and sulphur free top line thin cut-off wheels for all steels. Best suitable for stainless (except the 350 x 4 mm) and acid-resistant steel, hardox, heat-resistant cast steel, spring steel, mild and tool steel.

Characteristics: 50% less cutting time and 50% less dust than standard 3 mm thick discs. Lower material loss.



Type	Disc diameter (mm)	Thickness (mm)	Bore size (mm)	Pack quantity	Min. order quantity	Article Number	EAN Code	
41	SCS 41 / 76	76	1	10	5	1	4932464717	4058546226626
	SCS 41 / 115	115	1	22.2	1	50	4932451484	4002395163953
①	Counter display (200 x SCS 41 / 115 discs)				200	1	4932451485	4002395163960
	SCS 41 / 115	115	1.5	22.2	1	50	4932451486	4002395163977
	SCS 41 / 125	125	1	22.2	1	50	4932451487	4002395163984
①	Counter display (200 x SCS 41 / 125 discs)				200	1	4932451488	4002395163991
	SCS 41 / 150	150	1.5	22.2	1	25	4932471386	4058546290146
	SCS 41 / 180	180	1.5	22.2	1	25	4932451489	4002395161300
	SCS 41 / 230	230	1.9	22.2	1	25	4932451490	4002395161317
	SCS 41 / 350	350	4	25.4	1	10	4932471989	4058546298883

*Orders are only possible in master cartons. Order quantities greater than the pack quantity are to be ordered in multiples (i.e. 50, 100, 150...)

Metal cutting discs PRO+

Applications: Great performance in cutting mild steel with medium strength, plain alloy tool steel, concrete reinforcing iron and steel rebar.
 Characteristics: Efficient cutting properties in combination with high performance.

	Type	Disc diameter (mm)	Thickness (mm)	Bore size (mm)	Pack quantity	Min. order quantity	Article Number	EAN Code
41	SC 41 / 115	115	3	22.2	1	25	4932451491	4002395161324
	SC 41 / 125	125	3	22.2	1	25	4932451492	4002395161331
	SC 41 / 180	180	3	22.2	1	25	4932451493	4002395161348
	SC 41 / 230	230	3	22.2	1	25	4932451494	4002395161362
42	SC 42 / 115	115	3	22.2	1	25	4932451495	4002395161379
	SC 42 / 125	125	3	22.2	1	25	4932451496	4002395161393
	SC 42 / 180	180	3	22.2	1	25	4932451497	4002395162000
	SC 42 / 230	230	3	22.2	1	25	4932451498	4002395162017

*Orders are only possible in master cartons. Order quantities greater than the pack quantity are to be ordered in multiples (i.e. 50, 100, 150...)

Metal cutting discs for chop saws PRO+

Applications: For structural steels, tool steel, cast iron, hard high-grade steels and concrete reinforcing steel bars (rebar).
 Characteristics: Soft cutting wheel for chop saws.

	Type	Disc diameter (mm)	Thickness (mm)	Bore size (mm)	Pack quantity	Min. order quantity	Article Number	EAN Code
41	SC 41 / 355	355	2.5	25.4	1	10	4932451505	4002395162086

*Orders are only possible in master cartons. Order quantities greater than the pack quantity are to be ordered in multiples (i.e. 50, 100, 150...)

Metal grinding discs PRO+

Applications: Sound performance in mild steel and non alloy tool steel.
 Characteristics: Provides good lifetime and efficient grinding characteristics.

	Type	Disc diameter (mm)	Thickness (mm)	Bore size (mm)	Pack quantity	Min. order quantity	Article Number	EAN Code
27	SG 27 / 115	115	6	22.2	1	25	4932451501	4002395162048
	SG 27 / 125	125	6	22.2	1	25	4932451502	4002395162055
	SG 27 / 150	150	6	22.2	1	10	4932471387	4058546290153
	SG 27 / 180	180	6	22.2	1	10	4932451503	4002395162062
	SG 27 / 230	230	6	22.2	1	10	4932451504	4002395162079

*Orders are only possible in master cartons. Order quantities greater than the pack quantity are to be ordered in multiples (i.e. 50, 100, 150...)

Thin metal cutting discs - contractor series

Applications: Iron and sulphur free thin cut-off wheels for steel.

Suitable for acid-resistant steel, hardox, high-alloy steel, mild and tool steel. Not suitable for stainless steel.

	Type	Diameter (mm)	Thickness (mm)	Bore size (mm)	Pack quantity	Min. order quantity	Article Number	EAN Code
41	SCS 41 / 115	115	1	22.2	1	50	4932451474	4002395163250
	Counter display (200 x SCS 41 / 115 discs)				200	1	4932451475	4002395163267
	SCS 41 / 115	115	1.5	22.2	1	50	4932451476	4002395163274
	SCS 41 / 125	125	1	22.2	1	50	4932451477	4002395163281
	Counter display (200 x SCS 41 / 125 discs)				200	1	4932451478	4002395163298
	SCS 41 / 125	125	1.5	22.2	1	25	4932451479	4002395163908
	SCS 41 / 230	230	1.9	22.2	1	25	4932451480	4002395163915

*Orders are only possible in master cartons. Order quantities greater than the pack quantity are to be ordered in multiples (i.e. 50, 100, 150...)

Metal grinding discs - contractor series

Applications: suitable for mild steel. Not suitable for stainless steel.

	Type	Diameter (mm)	Thickness (mm)	Bore size (mm)	Pack quantity	Min. order quantity	Article Number	EAN Code
27	SG 27 / 115	115	6	22.2	1	25	4932451481	4002395163922
	SG 27 / 125	125	6	22.2	1	25	4932451482	4002395163939
	SG 27 / 230	230	6	22.2	1	10	4932451483	4002395163946

*Orders are only possible in master cartons. Order quantities greater than the pack quantity are to be ordered in multiples (i.e. 50, 100, 150...)

Thin ductile stone and multi material disc

Applications: Ductile iron, non-ferrous metals & stone.

* Minimum order quantity = 10 pcs. Orders > 10 pcs must be ordered in multiples of 10 (i.e. 10, 20, 30, 40)



	Type	Disc diameter (mm)	Thickness (mm)	Bore size (mm)	Pack quantity	Min. order quantity	Article Number	EAN Code
41	CCS 41 / 350	350	4	25.4	1	10	4932472264	4058546339104

Stone cutting discs PRO+

Applications: for concrete, masonry products and thin natural stone tiles.

	Type	Diameter (mm)	Thickness (mm)	Bore size (mm)	Pack quantity	Min. order quantity	Article Number	EAN Code
42	CC 42 / 115	115	3	22.2	1	25	4932451499	4002395162024
	CC 42 / 230	230	3	22.2	1	25	4932451500	4002395162031

*Orders are only possible in master cartons. Order quantities greater than the pack quantity are to be ordered in multiples (i.e. 50, 100, 150...)

Carbide Blade

Carbide blade suitable for cutting wood, plastic and plasterboard.

Diameter (mm)	Thickness (mm)	Bore size (mm)	Pack quantity	Min. order quantity	Article Number	EAN Code
76	1	10	1	1	4932464716	4058546226619



Flap discs

NEW

Maximum productivity with CERA TURBO™, 50% faster material removal and 2x longer lifetime vs. bonded disc.

Ceramic hybrid disc: grinds steel, stainless steel.

Plastic backing pad.

Highly flexible: perfectly adjusts to working piece.

Low heat development: no metal discolouration, especially on stainless steel.

Made in Germany.

Best for ferrous metals, stainless steel V2A (1.4301) / V4A (1.4401) and non-ferrous metals (aluminium, titan, etc.),

Orders must be in multiples of 10 pcs.



Type	Disc diameter (mm)	Grit	Bore size (mm)	Backing pad material	Pack quantity	Min. order quantity	Article Number	EAN Code	
50	SLC 50 / 115	115	40	22.2	Plastic	1	10	4932472228	4058546326241
	SLC 50 / 115	115	60	22.2	Plastic	1	10	4932472229	4058546326258
	SLC 50 / 115	115	80	22.2	Plastic	1	10	4932472230	4058546326265
	SLC 50 / 125	125	40	22.2	Plastic	1	10	4932472231	4058546326272
	SLC 50 / 125	125	60	22.2	Plastic	1	10	4932472232	4058546326289
	SLC 50 / 125	125	80	22.2	Plastic	1	10	4932472233	4058546326296

Flap discs Zirconium

NEW

High quality zirconium grain: longer lifetime on ferrous metals and stainless steel.

Suitable for ferrous metals, stainless steel V2A (1.4301) / V4A (1.4401).

Natural fibre backing pad: low vibration & noise, no harmful dust.

Highly flexible: perfectly adjusts to working piece.

Made in Germany.

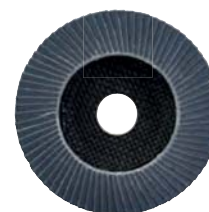

Type	Disc diameter (mm)	Grit	Bore size (mm)	Backing pad material	Pack quantity	Min. order quantity	Article Number	EAN Code	
50	SL 50 / 115	115	40	22.2	Natural Fibre	1	10	4932472220	4058546326166
	SL 50 / 115	115	60	22.2	Natural Fibre	1	10	4932472221	4058546326173
	SL 50 / 115	115	80	22.2	Natural Fibre	1	10	4932472222	4058546326180
	SL 50 / 115	115	120	22.2	Natural Fibre	1	10	4932472223	4058546326197
	SL 50 / 125	125	40	22.2	Natural Fibre	1	10	4932472224	4058546326203
	SL 50 / 125	125	60	22.2	Natural Fibre	1	10	4932472225	4058546326210
	SL 50 / 125	125	80	22.2	Natural Fibre	1	10	4932472226	4058546326227
	SL 50 / 125	125	120	22.2	Natural Fibre	1	10	4932472227	4058546326234

FIXTEC Nut

FIXTEC: Disc changing in seconds, no extra tools required.
 12 seconds from removing the worn disc to fixing a new disc.
 Only 8 mm thick, enabling more surface of disc on the material.
 Compatible to all manufacturers angle grinders up to Ø 150 mm with standard M14 spindle thread.
 With integrated keyholes, for removal of the nut with a standard pin spanner in the event of the nut becoming too tight.



Description	Pack quantity	Min. order quantity	Article Number	EAN Code
Counter display				
FIXTEC nut - M14 thread	1	12	4932352473	4002395371327



FIXTEC Nut XL

FIXTEC: Disc changing in seconds, no extra tools required.
 For large angle grinders Ø 180 mm to Ø 230.
 12 seconds from removing the worn disc to fixing a new disc.



Description	Pack quantity	Min. order quantity	Article Number	EAN Code
Counter display				
FIXTEC Nut for 180 & 230 mm angle grinders - M14 thread	1	12	4932464610	4058546225551



Abrasive discs - Hook & Loop

Perforated sanding discs for wood, metal, paint, lacquer, plaster.

Grit type: fused alumina, half open.

Artificial resin-bonded on special tear resistant paper.

Sanding sheets for random orbital sanders Ø 125 mm - 8 holes

Grit	Paper size diameter (mm)	Pack quantity	Min. order quantity	Article Number	EAN Code
40	125	5	1	4932367740	4002395338610
60	125	5	1	4932367741	4002395338627
80	125	5	1	4932367742	4002395338634
120	125	5	1	4932367743	4002395338641
180	125	5	1	4932367744	4002395338658
240	125	5	1	4932367745	4002395338665
40	125	25	1	4932371470	4002395341870
60	125	25	1	4932371396	4002395341665
80	125	25	1	4932371397	4002395341672
120	125	25	1	4932371398	4002395341689
180	125	25	1	4932371399	4002395341696
240	125	25	1	4932371400	4002395341702

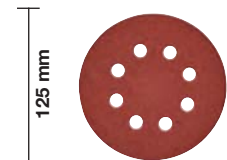

Sanding sheets for random orbital sanders Ø 150 mm - 6 holes

Grit	Paper size diameter (mm)	Pack quantity	Min. order quantity	Article Number	EAN Code
40	150	5	1	4932371590	4002395343171
60	150	5	1	4932371591	4002395343188
80	150	5	1	4932371592	4002395343195
120	150	5	1	4932371593	4002395343201
180	150	5	1	4932371594	4002395343218
240	150	5	1	4932371595	4002395343225
40	150	25	1	4932371596	4002395343232
60	150	25	1	4932371597	4002395343249
80	150	25	1	4932371598	4002395343256
120	150	25	1	4932371599	4002395343263
180	150	25	1	4932371600	4002395343270
240	150	25	1	4932371601	4002395343287

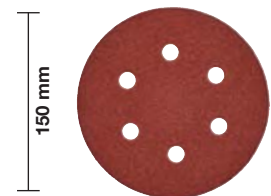

Abrasive sheets - Hook & Loop

Perforated sanding discs for wood, metal, paint, lacquer, plaster.

Grit type: fused alumina, half open.

Artificial resin-bonded on special tear resistant paper.

Sanding sheets for orbital sanders 80 x 133 mm

Grit	Paper size A x B (mm)	Pack quantity	Min. order quantity	Article Number	EAN Code
60	80 x 133	10	1	4932351666	4002395319305
80	80 x 133	10	1	4932351667	4002395319312
120	80 x 133	10	1	4932351668	4002395319329
180	80 x 133	10	1	4932351669	4002395319336
240	80 x 133	10	1	4932351670	4002395319343

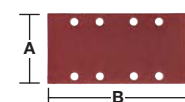

Sanding sheets for orbital sanders 115 x 107 mm

Grit	Paper size A x B (mm)	Pack quantity	Min. order quantity	Article Number	EAN Code
60	115 x 107	10	1	4932430815	4002395384761
80	115 x 107	10	1	4932430816	4002395384778
120	115 x 107	10	1	4932430817	4002395384785
240	115 x 107	10	1	4932430818	4002395384792

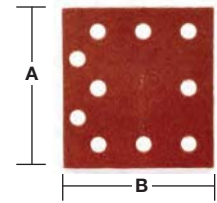

Abrasive sheets - Clamp type

Perforated sanding discs for wood, metal, paint, lacquer, plaster.

Grit type: fused alumina, half open. Artificial resin-bonded on special tear resistant paper.

Sanding sheets for orbital sanders 93 x 230 mm

Grit	Paper size A x B (mm)	Pack quantity	Min. order quantity	Article Number	EAN Code
50	93 x 230	10	1	4932305176	4002395300006
80	93 x 230	10	1	4932305177	4002395300013
100	93 x 230	10	1	4932305178	4002395300020
150	93 x 230	10	1	4932305179	4002395300037

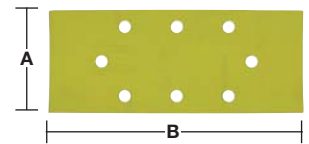

Sanding sheets for orbital sanders 115 x 140 mm

Grit	Paper size A x B (mm)	Pack quantity	Min. order quantity	Article Number	EAN Code
60	115 x 140	10	1	4932430819	4002395384815
80	115 x 140	10	1	4932430820	4002395384822
120	115 x 140	10	1	4932430822	4002395384846
240	115 x 140	10	1	4932430821	4002395384839

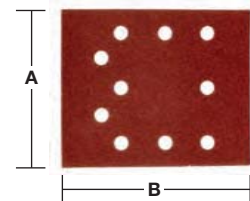

Abrasive sheets - Hook & Loop

Perforated sanding discs for wood, metal, paint, lacquer, plaster.

Grit type: fused alumina, half open. Artificial resin-bonded on special tear resistant paper.

Sanding sheets for delta sanders 105 x 105 mm

Grit	Paper size A x B (mm)	Pack quantity	Min. order quantity	Article Number	EAN Code
60	105 x 105	5	1	4932358492	4002395324248
80	105 x 105	5	1	4932358493	4002395324255
120	105 x 105	5	1	4932358494	4002395324262
180	105 x 105	5	1	4932358495	4002395324279
240	105 x 105	5	1	4932358496	4002395324286

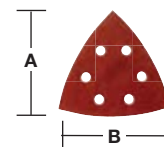

Sanding sheets for delta sanders 100 x 147 mm

Grit	Paper size A x B (mm)	Pack quantity	Min. order quantity	Article Number	EAN Code
60	100 x 147	10	1	4932355140	4002395319992
80	100 x 147	10	1	4932355141	4002395320004
120	100 x 147	10	1	4932355142	4002395320011
180	100 x 147	10	1	4932355143	4002395320028
240	100 x 147	10	1	4932355144	4002395320035

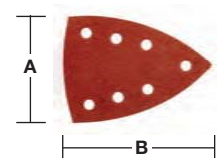

Abrasive belts

Cloth sanding belts for wood, metal, paint, lacqueur, plaster.

Grit type: fused alumina, half open.

Artificial resin-bonded on special fabric.

Sanding belts 75 x 533 mm

Grit	Paper size A x B (mm)	Pack quantity	Min. order quantity	Article Number	EAN Code
40	75 x 533	5	1	4932312475	4002395301263
60	75 x 533	5	1	4932312476	4002395301270
80	75 x 533	5	1	4932312477	4002395301287
100	75 x 533	5	1	4932312478	4002395301294
150	75 x 533	5	1	4932312479	4002395301300
240	75 x 533	5	1	4932312480	4002395301317

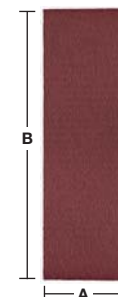

Sanding belts 100 x 560 mm

Grit	Paper size A x B (mm)	Pack quantity	Min. order quantity	Article Number	EAN Code
40	100 x 560	3	1	4932312099	4002395300419
60	100 x 560	3	1	4932312100	4002395300426
80	100 x 560	3	1	4932312101	4002395300433
100	100 x 560	3	1	4932312102	4002395300440
150	100 x 560	3	1	4932312103	4002395300457
240	100 x 560	3	1	4932312104	4002395300464

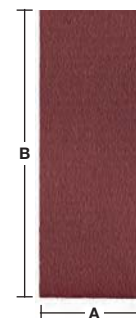

Sanding belts 100 x 610 mm

Grit	Paper size A x B (mm)	Pack quantity	Min. order quantity	Article Number	EAN Code
40	100 x 610	5	1	4932355066	4002395319824
60	100 x 610	5	1	4932355067	4002395319831
80	100 x 610	5	1	4932355068	4002395319848
100	100 x 610	5	1	4932355069	4002395319855
150	100 x 610	5	1	4932355070	4002395319862
220	100 x 610	5	1	4932355071	4002395319879

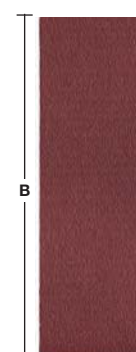





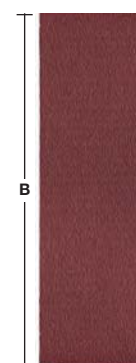









Sanding belts 100 x 620 mm

Grit	Paper size A x B (mm)	Pack quantity	Min. order quantity	Article Number	EAN Code
40	100 x 620	5	1	4932341610	4002395304882
60	100 x 620	5	1	4932341611	4002395304899
80	100 x 620	5	1	4932341612	4002395304905
100	100 x 620	5	1	4932341613	4002395304912
150	100 x 620	5	1	4932341614	4002395304929
220	100 x 620	5	1	4932341615	4002395304936



Rotary hammers - System attachments

Rotary hammer chuck adaptors

Tool Drive	Reception	Id. No. 4932	EAN Code 4002395	
① FIXTEC 	SDS-Plus	379877	346561	① 
② FIXTEC 	SDS-Plus	399152	357628	② 
③ FIXTEC 	SDS-Plus	352299	369584	③ 
④ FIXTEC 	1/2" x 20 UNF	371807	344710	④ 
⑤ FIXTEC 	1/2" x 20 UNF	399154	357635	⑤ 
⑥ SDS-Plus 	1/4" Hex	367438	337668	⑥ 
⑥ Chuck adaptor with direct bit reception (1/4" Hex) to accept screwdriving bits. Threaded housing enables adaptor to be tightened to the chuck resulting in no wobble.				
⑦ SDS-Plus 	1/2" x 20 UNF	367166	334438	⑦ 
⑦ Chuck adaptor with retaining screw.				

Rotary hammer dust extraction

Description	Pack quantity	Min. order quantity	Article Number	EAN Code
① Dust collection ring for collecting dust when overhead drilling. Suitable for Ø 5 - 8 mm	1	1	4932430912	4002395385744
② Extractor for dust collection on the wall or when overhead drilling. Maximum diameter drill bit Ø 28 mm. Fits to all industrial dust extraction units (universal reception Ø 26 - 41 mm)	1	1	4932430446	4002395381074
③ Drilling shroud - PHDE72. For drilling and coring from Ø 6 - 72 mm. Brush insert to improve suction and extraction. Brushes to be removed for coring applications. Outlet nozzle: Ø 37 mm outside / Ø 32 mm inside. Replacement sealing lips (2 pcs): 4931448564. Replacement brush: 4931448565	1	1	4932430480	4002395381418
④ Drilling shroud - PHDE152. For drilling and dry coring from Ø 25 - 152 mm. Brush insert to improve suction and extraction.	1	1	4932471990	4058546298890
DE16 - Vac assist universal extractor				
⑤ DE16 unit, 1 x side handle and 3 x neck collars- allows fitting to drills with gear neck from Ø 43 - 59 mm. 2 x drilling nozzles (49902301)	1	1	4932430835	4002395384976



SDS-Plus dust trap

Universal fit - Fits ALL SDS-Plus rotary hammer brands and styles.

Fits ALL SDS-Plus drill bits up to 215mm total length.

Fits ALL standard vacuum cleaners.

Clear sleeve for visibility & accuracy.

Collects up to 99% of airborne dust.

Useable with or without vacuum cleaner.



Description	Pack quantity	Min. order quantity	Article Number	EAN Code
SDS-Plus dust trap	1	1	4932464916	4058546228613
SDS-Plus dust trap sleeve	1	1	4932464917	4058546228620



Screwdrivers - System attachments

Description	Fits corded screwdrivers	Pack quantity	Min. order quantity	Article Number	EAN Code
① Drywall sleeve assembly	DWE 4000 Q, DWSE 4000 Q, TKSE 2500 Q, 6790, 6743	1	1	49261036	045242185245
② Self drill sleeve assembly	TKSE 2500 Q, 6790	1	1	49261082	045242185375
1/4" magnetic bit holder 76 mm	DWE 4000 Q, DWSE 4000 Q, 6743	1	1	48323065	045242128600
1/4" magnetic bit holder 76 mm, requires additionally 49261036 sleeve assembly	TKSE 2500 Q, 6790	1	1	48323070	045242128655
③ Hex socket driver set (3pc) Ø 6 / 8 / 10 mm magnetic sockets	TKSE 2500 Q, 6790, TQSE 1200 Q, TQSE 2500 Q, 6580, 6581	3	1	49663004	045242207848
④ Collated attachment for M18 FSG		1	1	4933459202	4002395289974
⑤ PH2 148 mm drywall screwdriving bit for M18 FSG		3	1	4932459393	4058546010546
⑥ Mag / ring drywall bit holder 75 mm for M18 FSG		1	1	4932459394	4058546010553
⑦ Offset attachment 1/4" hex M12FPDX		1	1	4932464481	4058546224264
⑧ M12 FPDX-RAA Right angle attachment for drilling and screwdriving applications in confined spaces. 90° angle. 12 fixing positions. Direct bit reception.		1	1	4932464480	4058546224257
⑨ 13 mm Keyless chuck to suit M12 FPDX sub compact percussion drill		1	1	4932464479	4058546224240
⑩ Rivet tool nose set		4	1	48540100	045242504466
⑪ 152mm Nose extension kit- for M12™ rivet tool		3	1	48950100	045242504459
⑫ M12 BDDX-OA offset attachment for screwdriving applications - 12 fixing positions		1	1	4932430432	4002395380930
⑬ M12 BDDX-RAA right angle attachment for drilling and screwdriving applications in confined spaces - 90° angle - 12 fixing positions - direct bit reception		1	1	4932430433	4002395380947



Side handles

Description	Pack quantity	Min. order quantity	Article Number	EAN Code
① Side handle with depth gauge for all drills and percussion drills with gear neck diameter 43 mm	1	1	4932373725	4002395352647
② Side handle with depth gauge for all drills and percussion drills with a short gear neck (13 mm) of diameter 43 mm	1	1	4932364149	4002395342198



QUIK-LOK[™] cables

Cable length (m)	Country version	Pack quantity	Min. order quantity	Article Number	EAN Code
4	EU	1	1	4932373502	4002395351725
10	EU	1	1	4932373503	4002395351732
4	CH	1	1	4932373504	4002395351749
4	GB	1	1	4932373508	4002395351787
6	EU	1	1	4932364483 ¹	4002395337620
QUIK-LOK cable repair kit		1	1	4931380758	4002395714551



¹Heavy duty and acid resistant, non repairable

Universal right angle drill attachment

Converts MILWAUKEE[®] HDE 13 RQD straight drill to angle drill.

Used extensively for drilling between joists or in tight corners.

Head and handle swivel 360°.

Provides two speeds: 1. Low: speed decreases by 30% torque increases by 50% 2. High: speed increases by 50%

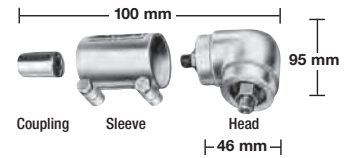

Description	Pack quantity	Min. order quantity	Article Number	EAN Code
Right angle drill attachment	1	1	48062871	045242088812



Head and handle swivel 360° and can be locked tight in any position.

Impact wrenches - System attachments

Description	Pack quantity	Min. order quantity	Article Number	EAN Code
Detent pin square type: Socket will not slip off unless detent pin is pressed in	1	1	49170405	045242178919

Description	Pack quantity	Min. order quantity	Article Number	EAN Code
Rubber Sleeve for M18 CIW	1	1	49162754	045242320455
Rubber Sleeve for M18 CHIW and M28 CHIW	1	1	49162763	045242324255
Rubber Sleeve for M18 FMTIWP	1	1	49162861	045242510146
Rubber Sleeve for M18 FHIWP12 & M18 ONEFHIWP12	1	1	49162766	045242506415
Rubber Sleeve for M18 FHIWF12, M18 ONEFHIWF12 & M18 ONEFHIWF34	1	1	49162767	045242506422
Rubber Sleeve for M18 FIW2F & M18 FW2P	1	1	4932478770	4058546360528
Rubber Sleeve for M18 ONEFHIWF1	1	1	4932478760	4058546360429
Rubber Sleeve for M18 FMTIW2F & M18 FMTIW2P	1	1	4932478771	4058546360535
Rubber Sleeve for M12 FIWF	1	1	4932478758	4058546360405



Keyed chucks

Chuck jaws open (mm)	Drill reception	Locking device	Safety screw	Rotary drill	Percussion drill	Battery drill	Chuck key	Pack quantity	Min. order quantity	Article Number	EAN Code
1.5-13	1/2" x 20		✓	✓	✓	✓	A	1	1	4932267980	4002395300488
1.0-16	Taper B16			✓			C	1	1	4932127010	4002395306169
3.0-16	M18x2.5	✓	✓	✓	✓		C	1	1	4932320014	4002395310784



Keyed chucks - machine specific

Chuck jaws open (mm)	Drill reception	Fits drill drivers	Safety screw	Chuck key	Pack quantity	Min. order quantity	Article Number	EAN Code
1.0-10	3/8" x 24	HDE 6 RQ	✓	H	1	1	48660817	045242155705
2.0-13	1/2" x 20	HDE 13 RQD	✓	K	1	1	48661355	045242156542



Keyed chucks with 1/4" Hex reception

Chuck jaws open (mm)	Drill reception	Battery drill	Chuck key	Pack quantity	Min. order quantity	Article Number	EAN Code
1.0-10	1/4" Hex	✓	A	1	1	4932314867	4002395300112



Chuck keys

Description	Type	Ref. No.	Pack quantity	Min. order quantity	Article Number	EAN Code
① Chuck key	A	S2A	1	1	4932221378	4002395302765
	B	S2AT	1	1	4932310612	4002395309177
	C	S3T	1	1	4932221379	4002395306381
	D	S14	1	1	4932304684*	4002395300105
	E	S4	1	1	4932221380	4002395306398
	G	S2	1	1	4932319995	4002395303724
	H		1	1	48663350	045242157600
	J		1	1	48663240	045242157501
② Morse taper No. 3 adaptor for chucks with B16 taper			1	1	4932117042	4002395305834
	Ejector tool DIN 317 size 3		1	1	4932604226	4002395311248



* while stocks last

Keyless chucks

Keyless chucks 2 sleeves

Chuck jaws open (mm)	Reception	Locking device	Safety screw	Rotary drill	Percussion drill	Battery drill	Pack quantity	Min. order quantity	Article Number	EAN Code
1.0-10	3/8" x 24		✓	✓		✓	1	1	4932349457	4002395318155
1.0-10	1/2" x 20	✓	✓	✓	✓	✓	1	1	4932364382	4002395337675
1.5-13	1/2" x 20	✓		✓	✓	✓	1	1	4932376531	4002395346332
1.5-13	1/2" x 20	✓	✓	✓	✓	✓	1	1	4932376533	4002395346349
1.5-13	1/2" x 20	✓		✓	✓	✓	1	1	4932364265 ¹	4002395334056
1.5-13	1/2" x 20	✓	✓	✓	✓	✓	1	1	4932364267	4002395334070



¹ Industrial quality

Keyless chucks for FIXTEC (spindle lock) machines

Chuck jaws open (mm)	Reception	Locking device	Safety screw	Rotary drill	Percussion drill	Battery drill	Pack quantity	Min. order quantity	Article Number	EAN Code
1.0-10	3/8" x 24	✓	✓	✓	✓	✓	1	1	4932371018	4002395339365
1.0-10	1/2" x 20	✓	✓	✓	✓	✓	1	1	4932372443	4002395345458
1.5-13	1/2" x 20	✓	✓	✓	✓	✓	1	1	4932371913	4002395345366
1.5-13	3/8" x 24	✓	✓	✓	✓	✓	1	1	4932399492	4002395361137
1.5-13	9/16" x 18	✓	✓	✓	✓	✓	1	1	4932478806 ¹	4058546360887



¹ Fits M18 FDD(2)/ M18 FPD(2)

Industrial keyless chucks for corded percussion drills

Chuck jaws open (mm)	Reception	Locking device	Rotary drill	Percussion drill	Battery drill	Pack quantity	Min. order quantity	Article Number	EAN Code
1.0-13	1/2" x 20	✓	✓	✓		1	1	4932364266	4002395334063



Keyless chucks - specific tool related chucks

Chuck jaws open (mm)	Reception	Machine specific	Locking device	Rotary drill	Safety screw	Pack quantity	Min. order quantity	Article Number	EAN Code
① 1.0-10	1/2" x 20	HDE 10 RQX			✓	1	1	48661520	045242156795
① 1.5-13	1/2" x 20	HDE 13 RQX			✓	1	1	42660755	4002395891436
② 1.5-13	FIXTEC		✓	✓		1	1	4932399214	4002395358236
③ 1.0-10	FIXTEC	M12 BDDX		✓		1	1	4932430444	4002395381050



Angle grinders - System attachments

Description	Fits 115 mm angle grinders	Fits 125 mm angle grinders	Fits 150mm angle grinders	Fits 180mm angle grinders	Fits 230mm angle grinders	Pack quantity	Min. order quantity	Article Number	EAN Code
① Flange nut M14	✓	✓	✓	✓	✓	1	1	4932345628	4002395313105
② Backing flange	✓	✓	✓	✓	✓	1	1	4932449324	4002395245185
③ Two hole spanner straight	✓	✓	✓	✓	✓	1	1	4932367712	4002395338467
④ Open-ended spanner. SW 17/24	✓	✓	✓	✓	✓	1	1	4932345710	4002395307722
⑤ Cranked two hole spanner for steel wire brushes				✓	✓	1	1	4932371469	4002395342181
⑥ Dust protection grille against entry of ground particles		✓	✓			1	1	4932329397	4002395303892
				✓	✓	2	1	4932326525	4002395303311
Side handle	✓	✓	✓			1	1	4932409546	4002395370870
				✓	✓	1	1	4931433531	4002395889259
⑦ Anti-Vibration side handle	✓	✓	✓	✓ ¹		1	1	4932399991	4002395366507
				✓	✓	1	1	4932399992	4002395366514
Hand protection guard						1	1	4932378478	4002395347353
Flange nut set. Only for AGV 16- 180 QXC. Suitable for WS 2300 (Australia version)						3	1	4932351632	4002395321636
Flange nut M14 (4932345629), backing flange (4932371404), large flange nut (4932367952)									

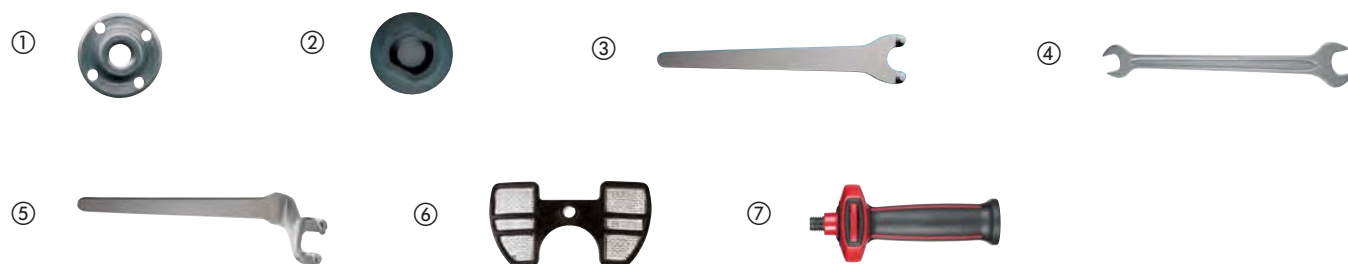

Flexible backing pads

Description	Bore size (mm)	Diameter (mm)	Fits 115 mm angle grinders	Fits 125 mm angle grinders	Fits 180mm angle grinders	Fits 230mm angle grinders	Pack quantity	Min. order quantity	Article Number	EAN Code
Flexible backing pad. Complete with flange nut M14 for all angle grinders	14.2	110	✓				1	1	4932345760	4002395313488
	14.2	125		✓			1	1	4932345761	4002395313495
	14.2	170			✓		1	1	4932345758	4002395313501
	22.2	170			✓		1	1	4932352744	4002395374021
Replacement flange nut M14			✓	✓	✓	✓	1	1	4932345627	4002395313112

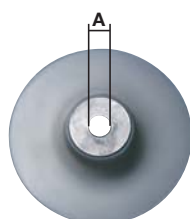

Cutting and grinding dust extraction

Description	Fits 115 mm angle grinders	Fits 125 mm angle grinders	Fits 180mm angle grinders	Fits 230mm angle grinders	Pack quantity	Min. order quantity	Article Number	EAN Code
<p>① Dust guard for cutting - DEC 125. 100% tool free connection to Ø 115 - 125 mm AG(V) 12, AGV 15 series and FUEL[™] grinders, keyless depth adjustment from 5 - 28 mm. Guide to prevent twisting during cutting. Dust guard fits to the MILWAUKEE[®] M-Class cleaners with unique "click-system" adaptor supplied with the vacuum cleaner</p>	✓	✓			1	1	4932430467	4002395381289
<p>② Dust guard for surface conditioning - DEG 125. 100% tool free connection to Ø 125 mm AG(V) 12, AGV 15 series and FUEL[™] grinders. Supplied with additional loop handle. Removable magnetic front cover to gain access to tight corners and edges when using a cup wheel. Dust guard fits to the MILWAUKEE[®] M-Class cleaners with unique "click-system" adaptor supplied with the vacuum cleaner. Includes replaceable brush 4931448429</p>		✓			1	1	4932430468	4002395381296
<p>③ Dust guard for cutting - DEC 230. 100% tool free connection to Ø 180 - 230mm AG 22, keyless depth adjustment from 5 - 60mm. Solid steel cutting guide to prevent twisting during cutting and flexible cutting line indicator for plunge cuts. Dust guard fits to the MILWAUKEE[®] M-Class cleaners with unique "click-system" adaptor supplied with the vacuum cleaner.</p>			✓	✓	1	1	4932459340	4058546010010
<p>③ Dust guard for cutting - DEC 230 K. 100% tool free connection to Ø 180 - 230mm AG21, AGV 22, AG 24, AGVK 24 and FUEL[™] grinders. Does not fit to LAG's equipped with autobalancer. Keyless depth adjustment from 5 - 60mm. Solid steel cutting guide to prevent twisting during cutting and flexible cutting line indicator for plunge cuts. Dust guard fits to the MILWAUKEE[®] M-Class cleaners with unique "click-system" adaptor supplied with the vacuum cleaner.</p>			✓	✓	1	1	4932459341	4058546010027



Die grinders - System attachments

Description	Fits die grinders	Pack quantity	Min. order quantity	Article Number	EAN Code
Ø 3 mm collet	DGL 34,DGL 30 E,DG 30 E, PSG 12,PSG 14.4 PP, HD18 SG	1	1	4932308974	4002395309092
Ø 3 mm collet	M18 FDG	1	1	4932471202	4058546288303
Ø 6 mm collet	PSG 14.4 PP,HD18 SG, PSG 12,DG 30 E,DGL 30 E, DGL 34	1	1	4932313192	4002395302833
Ø 6 mm collet	DG 7 E	1	1	4931391453	4002395734818
Ø 6 mm collet	DG 14-50 Q	1	1	48660978	045242155620
Ø 8 mm collet	DGL 34,DGL 30 E,DG 30 E, PSG 12,PSG 14.4 PP, HD18 SG,V 28 SG	1	1	4932313190	4002395302840
Ø 8 mm collet	DG 7 E	1	1	4931391452	4002395734801
Ø 6.35 mm (1/4") collet	DGL 34,DGL 30 E,DG 30 E, PSG 12,PSG 14.4 PP, HD18 SG	1	1	4932313194	4002395302857
① Rubber Sleeve for M12 FDGA	M12 FDGA	1	1	4932478759	4058546360412



Plate shears - System attachments

Description	Fits plate shears	Pack quantity	Min. order quantity	Article Number	EAN Code
Piston four sided blade	PPS 12	1	1	4932308837	4002395311583
Cutting table blade four sided blade	KS 2.5,S 2.5	1	1	4932430171	4002395378326
	PPS 12	1	1	4932308838	4002395309085
Centre blade	SMC 1.2 Q	1	1	48440150	045242140701
Left blade	SMC 1.2 Q	1	1	48440160	045242140756
Right blade	SMC 1.2 Q	1	1	48440170	045242140800
Socket wrench 9/32"	SMC 1.2 Q	1	1	49960070	045242221554
Replacement shear head assembly.	SMC 1.2 Q	1	1	48080500	045242089253



Nibblers - System attachments

Description	Fits nibblers	Pack quantity	Min. order quantity	Article Number	EAN Code
Punch	KN 2 PN 14.4, PN 12,N 2	1	1	4932430172	4002395378333
Die	KN 2 PN 14.4, PN 12,N 2	1	1	4932279565	4002395308521
Special die. Especially designed for cutting corrugated steel. Max. cutting capacity 1.5 mm	KN 2 PN 14.4, PN 12,N 2	1	1	4932279498	4002395308514



Polishers - System attachments

Premium - Hook & Loop Ø 125 mm

Description	Diameter (mm)	Height (mm)	Pack quantity	Min. order quantity	Article Number	EAN Code
<p>Polishing backing pad with M14 thread. Very flat design with excellent flexibility. Low vibration allows precise work on any flat and curved profiles</p> <p>①</p>	125		1	1	4932430394	4002395380558
<p>Lambswool polishing disc. 100% natural lambswool. Premium quality with extremely high fibre density for longer lifetime. Integrated soft touch layer guarantees perfect adjustment to flat and curved profiles. For finishing old and fresh paint. Extremely good polishing of temperature sensitive clear lacquers thanks to heat resistant fibres, e.g. polishing car bumper</p> <p>②</p>	135	25	1	1	4932430395	4002395380565
<p>Polishing sponge hard. Hard sponge with coarse foam structure. For maximum removal of the reconditioning lacquer, removing deep scratches and polishing weather-beaten lacquer</p> <p>③</p>	145	30	1	1	4932430396	4002395380572
<p>Polishing sponge soft. Extremely soft sponge with fine foam structure. For fine polishing with polishing creams / wax compounds to remove very fine scratches and holograms (swirls)</p> <p>④</p>	145	30	1	1	4932430397	4002395380589
<p>Microfibre polishing cloth. Super-soft premium microfibre polishing cloth for finishing gloss polishing. With good absorption properties perfectly suited for final finishing and removing water spots from sensitive surfaces. Machine-washable with 30° without softener</p> <p>⑤</p>	400 x 400		1	1	4932430398	4002395380596
<p>Polish M-Cut 1500 (250 ml). A coarse 1500 grit polish for removing deep scratches without damaging the lacquer. Suitable for removing dust grains, orange peel texture, lacquer/paints runs and deep scratches. Free of wax, silicone and roxic solvents. Recommended for use with polishing sponge hard (4932430396) and lambswool polishing disc (4932430395)</p> <p>⑥</p>			1	1	4932430475	4002395381364
<p>Polish M-Wax 6000 (250 ml). Premium high-tech wax with 6000 grit for removing fine scratches and sealing the paintwork in one step. Excellent performance in removing fine scratches / holograms / swirls. Contains the finest Brazilian Carnuba wax for long lasting mirror-like shine. Free of silicone. Recommended for use with polishing sponge soft (4932430397) and microfibre polishing cloth (4932430398)</p> <p>⑦</p>			1	1	4932430476	4002395381371



TiD-extra
 Industrial Technologies d.o.o.

Hook & Loop Ø 150 mm

Description	Diameter (mm)	Height (mm)	Pack quantity	Min. order quantity	Article Number	EAN Code
Polishing backing pad. Application: Reception of felt / lambswool polishing discs and sponges. ① Characteristics: M14 thread, break resistant with integrated soft and flexible foam layer, Hook & Loop fixation	150	25	1	1	4932373161	4002395347285
Felt polishing disc. Application: second polishing / finish of new lacquer work (spray mist and inclusion of dust), non ferrous metals and stainless steel, can also be used with polishing paste. Requires polishing backing	150	50	1	1	4932373163	4002395347902
Lambswool polishing disc. Finishing high gloss polishing	150	25	1	1	4932373164	4002395347926
Polishing sponge hard. Polish up of weather-beaten lacquer, lacquer re-conditioning	150	50	1	1	4932373165	4002395347940
Polishing sponge soft. Second polish of lacquer, lacquer care	150	50	1	1	4932373186	4002395347964



Spot polisher

Description	Diameter (mm)	Height (mm)	Pack quantity	Min. order quantity	Article Number	EAN Code
Polishing / Sanding backing pad. Thread: M9 x 0.75. ① Hook and loop fixation. For use with polishing sponges and abrasive paper	76		1	1	4932430488	4002395381494
Polishing sponge - Hard (yellow). Hard sponge for use with more aggressive polish for removal of deep scratches. Hook and loop fixation. For use with polishing / sanding backing pad	75	25	1	1	4932430489	4002395381500
Polishing sponge - Soft (white). Soft sponge for use with light polish for removal of small scratches. Hook and loop fixation. For use with polishing / sanding backing pad	80	25	1	1	4932430490	4002395381517
Lambswool polishing pad. ④ Hook and loop fixation. For use with polishing / sanding backing pad	80		1	1	4932430838	4002395385003
Fibre disc backing pad. Thread: M9 x 0.75 to affix to tool. Knurled thread to fix coated abrasives and surface finishing ⑤ products for coarse sanding applications, such as rust removal. Ideal for sanding small or awkward to reach areas such as pinch welds, door shuts and wheel arches	46		1	1	4932430492	4002395381531



Sanders - System attachments

Random orbital sanders

Description	Diameter (mm)	Fits random orbital sanders	Pack quantity	Min. order quantity	Article Number	EAN Code
① Base plate Ø 125 mm, 8 holes. Complete with rubber ring as spare	125	ROS 125 E	2	1	4932430091	4002395377527
① Base plate Ø 150 mm, 6 holes. Complete with rubber ring as spare	150	TXE 150, ROS 150 E	2	1	4932357591	4002395343317
		ROS 150 E			4932430145	4002395378067
Clean Line System. Frame with dust bag	125	ROS 125 E	1	1	4931435448	4002395889563
	150	ROS 150	1	1	4931435911	4002395874729
Spare paper bags for 4932345544		TXE 150, TX 125, ROS 150 E	5	1	4931442873	4002395247882
Frame holder for dust bag 4932313096	125/150	ROS 150 E, TXE 150	1	1	4931329719	4002395610938
② Lambswool polishing disc. Finishing high gloss polishing	150	ROS 150, ROS 150 E, TXE 150	1	1	4932373164	4002395347926
③ Lambswool polishing disc. 100% natural lambswool. Premium quality with extremely high fibre density for longer lifetime. Integrated soft touch layer guarantees perfect adjustment to flat and curved profiles. For finishing old and fresh paint. Extremely good polishing of temperature sensitive clear lacquers thanks to heat resistant fibres, e.g. polishing car bumper	135	TX 125, ROS 125 E	1	1	4932430395	4002395380565
④ Polishing sponge hard. Polish up of weather-beaten lacquer, lacquer re-conditioning	150	TXE 150, ROS 150 E, ROS 150	1	1	4932373165	4002395347940
⑤ Polishing sponge hard. Hard sponge with coarse foam structure. For maximum removal of the recondition-ing lacquer, removing deep scratches and polishing weather-beaten lacquer	145	TX 125, ROS 125 E	1	1	4932430396	4002395380572

①



②



③



④



⑤



Orbital sanders

Description	Fits orbital sanders	Pack quantity	Min. order quantity	Article Number	EAN Code
Spare paper bags for 4932345544	VSS 20,VSSE 20, VSS 22,VSSE 22, VS 230,VSS 260, VSSE 260	5	1	4931442873	4002395247882



Delta sanders

Description	Fits delta sanders	Pack quantity	Min. order quantity	Article Number	EAN Code
Dust bag made of sturdy fabric	VS 11 D,FS 2, FS 2 D	1	1	4932351675	4002395320103



Belt sanders

Description	Fits belt sanders	Pack quantity	Min. order quantity	Article Number	EAN Code
Dust bag (spare)	BS 100 S,BS 100 LE	1	1	4932336597	4002395311026
Pair of clamps for MILWAUKEE® belt sander.		2	1	4932459653	4058546028251



Bandsaws - System attachments

Bandsaw covers

Safety - Protects user from injuries by preventing any access to the blade

Jobsite Armor[™] durability - Proprietary composite material and crush zone barriers absorb impacts and protect the tool

Protection from debris - Covers protect the blade track and the pulley wheels from debris entering the tool and affecting overall performance

Tool-free installation and removal within second

Extends life of blade by protecting it from external objects



Description	Pack quantity	Min. order quantity	Article Number	EAN Code
① Bandsaw Cover for HD18 BS	1	1	4932471458	4058546290863
② Bandsaw Cover for M18 FBS85	1	1	4932472241	4058546326371
③ Bandsaw Cover for M18 CBS125 & BS 125	1	1	4932471459	4058546290870

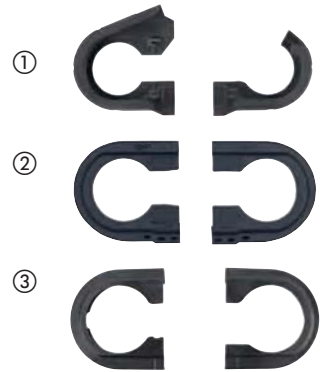

Circular saws - System attachments

Description	Fits circular saws	Pack quantity	Min. order quantity	Article Number	EAN Code
Dust absorption connector.	PCS 55	1	1	4932369282	4002395338412
Spanner for removing saw blade.	CS 55, HK 46 N, SCS 65 Q, CS 75, PCS 55, HKS 75, HK 75 A, HKS 85, PMS 18	1	1	4932371469	4002395342181
Parallel guide / fence	SCS 65 Q	1	1	49224146	045242181896
Plastic transport case	SCS 65 Q	1	1	201672001	4002395840519
① Dust extraction hood for MS216 mitre saw		1	1	4932430005	4002395376667
② Guide rail GRU 1400. 1400 mm long. Supplied with carry bag		1	1	4932451265	4002395170197
Connector Piece		1	1	4932352559	4002395372171
Strip and rubber lip assembly set		1	1	4931433774	4002395887620



Biscuit jointers - System attachments

Description	Fits biscuit jointers	Pack quantity	Min. order quantity	Article Number	EAN Code
Cutter	LF 650 PJ 710	1	1	4932361072	4002395326679
Frame holder for dust bag 4931443872	LF 650 PJ 710	1	1	4931442872	4002395247899
Spare paper bags for 4932345544	LF 650 PJ 710	5	1	4931442873	4002395247882
Two hole spanner.	LF 650 PJ 710	1	1	4932345712	4002395305551



Planers - System attachments

Description	All planers 82 & 102mm	Pack quantity	Min. order quantity	Article Number	EAN Code
Parallel guide	✓	1	1	4932274071*	4002395300358
Folding rebate depth gauge. For all planers except H500 / PR 1.6-82 models	✓	1	1	4932274069	4002395300129

Planer blades

Description	Width (mm)	Fits planers	Pack quantity	Min. order quantity	Article Number	EAN Code
Tungsten carbide reversible blades. Two reversible blades, suitable for soft and hardwoods	82 mm	M18 BP, H 500, H 750	2	1	4932273484	4002395300150
	102 mm	HB 750, HBE 800	2	1	4932316243	4002395300167



Routers - System attachments

Description	Fits routers	Pack quantity	Min. order quantity	Article Number	EAN Code
Precision collet for router. High rotation accuracy.					
Ø 3 mm collet	OFE 710, OFE 630	OFS 450	1	4932308974	4002395309092
Ø 6.35 mm (1/4") collet	OFE 710, OFE 630	OFS 450	1	4932313194	4002395302857
Ø 6 mm collet	OFE 710, OFE 630	OFS 450	1	4932313192	4002395302833
Ø 8 mm collet	OFE 710, OFE 630	OFS 450	1	4932313190	4002395302840
Trim router off set base attachment, for trimming close to walls	M18 FTR	1	1	4932471946	4058546298456
12 pcs router bit set - 8 mm shank		12	1	4932451668	4002395275564

①



②



③



Outdoor products - System attachments

Chainsaws

Description	kerf [mm]	Drive Links	Pitch [mm]	Pack quantity	Min. order quantity	Article Number	EAN Code
16" / 406.4 mm saw chain	1.1	56	9.5 (3/8")	1	1	4932464873	4058546228187
12" / 304.8 mm saw chain	1.1	45	9.5 (3/8")	1	1	4932471385	4058546290139
10" / 254 mm saw chain	1.1	40	9.5 (3/8")	1	1	4932471329	4058546289577
6" / 152 mm saw chain	1.1	28	9.5 (3/8")	1	1	4932478427	4058546346188



Line trimmers

Description	Pack quantity	Min. order quantity	Article Number	EAN Code
2 mm x 45 m trimmer line	1	12	49162712	045242493906
2.4 mm x 76 m trimmer line	1	10	49162713	045242493913
Auto feed trimmer replacement spool (includes 49162712 line)	1	1	49162714	045242006458



Edger

Replacement edger blade to fit M18 FOPH-EA edger attachment.
20.3 cm / 203mm blade length.

Description	Length (mm)	Pack quantity	Min. order quantity	Article Number	EAN Code
Edger blade - 1pc	203	1	1	4932471330	4058546289584



Crimpers - System attachments

Crimping dies for M18™ FORCE LOGIC™ HCCT

Type	Form	Cable lug size (mm ²)	Imprint code	Description	Pack quantity	Min. order quantity	Article Number	EAN Code
① NF C 20-130 for copper compression cable lugs	Hex	16	16	NF22 Cu 16	1	1	4932451733	4002395276837
		25	25	NF22 Cu 25	1	1	4932451734	4002395276844
		35	35	NF22 Cu 35	1	1	4932451735	4002395276851
		50	50	NF22 Cu 50	1	1	4932451736	4002395276868
		70	70	NF22 Cu 70	1	1	4932451737	4002395276875
		95	95	NF22 Cu 95	1	1	4932451738	4002395276882
		120	120	NF22 Cu 120	1	1	4932451739	4002395276899
		150	150	NF22 Cu 150	1	1	4932451740	4002395277506
		185	185	NF22 Cu 185	1	1	4932451741	4002395277513
		240	240	NF22 Cu 240	1	1	4932451742	4002395277520
② DIN 46235 for copper compression cable lugs and connectors (DIN 46267)	Hex	6	5	DN22 Cu 6	1	1	4932464861	4058546228064
		10	6	DN22 Cu 10	1	1	4932464862	4058546228071
		16	8	DIN22 Cu 16	1	1	4932451744	4002395277551
		25	10	DIN22 Cu 25	1	1	4932451745	4002395277568
		35	12	DIN22 Cu 35	1	1	4932451746	4002395277575
		50	14	DIN22 Cu 50	1	1	4932451747	4002395277582
		70	16	DIN22 Cu 70	1	1	4932451748	4002395277599
		95	18	DIN22 Cu 95	1	1	4932451749	4002395278206
		120	20	DIN22 Cu 120	1	1	4932451750	4002395278213
		150	22	DIN22 Cu 150	1	1	4932451751	4002395278220
185	25	DIN22 Cu 185	1	1	4932451752	4002395278237		
240	28	DIN22 Cu 240	1	1	4932451753	4002395278244		
300	32	DIN22 Cu 300	1	1	4932451754	4002395278251		

①

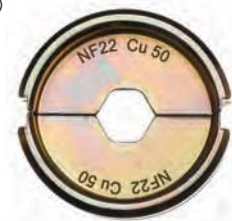

②



Crimping dies for M18™ FORCE LOGIC™ HCCT

Type	Form	Cable lug size (mm ²)	Imprint code	Description	Pack quantity	Min. order quantity	Article Number	EAN Code
③ Tubular cable lugs and connectors	Hex	16	16	R22 Cu 16	1	1	4932451755	4002395278268
		25	25	R22 Cu 25	1	1	4932451756	4002395278275
		35	35	R22 Cu 35	1	1	4932451757	4002395278282
		50	50	R22 Cu 50	1	1	4932451758	4002395278299
		70	70	R22 Cu 70	1	1	4932451759	4002395278909
		95	95	R22 Cu 95	1	1	4932451760	4002395278916
		120	120	R22 Cu 120	1	1	4932451761	4002395278923
		150	150	R22 Cu 150	1	1	4932451762	4002395278930
		185	185	R22 Cu 185	1	1	4932451763	4002395278947
		240	240	R22 Cu 240	1	1	4932451764	4002395278954
④ Copper solderless terminals (DIN 46234, DIN 46230, DIN 46341)	Half round indent	16	16	Q22 CU 16	1	1	4932451766	4002395278978
		25	25	Q22 CU 25	1	1	4932451767	4002395278985
		35	35	Q22 CU 35	1	1	4932451768	4002395278992
		50	50	Q22 CU 50	1	1	4932451769	4002395279609
		70	70	Q22 CU 70	1	1	4932451770	4002395279616
⑤ DIN Aluminium for aluminium compression cable lugs and connectors (DIN 46329, 46267 Part 1 and 2, DIN EN 50182)	Hex	16/25	12	DIN22 AL 16/25	1	1	4932451771	4002395279623
		35	14	DIN22 AL 35	1	1	4932451772	4002395279630
		50	16	DIN22 AL 50	1	1	4932451773	4002395279647
		70	18	DIN22 AL 70	1	1	4932451774	4002395279654
		95/120	22	DIN22 AL 95/120	1	1	4932451775	4002395279661
		150	25	DIN22 AL 150	1	1	4932451776	4002395279678
		185	28	DIN22 AL 185	1	1	4932451777	4002395279685
240	32	DIN22 AL 240	1	1	4932451778	4002395279692		
⑥ Copper tubular cable lugs and connectors like L series	Hex	300	34	DIN22 AL 300	1	1	4932451779	4002395279695
		16	8	L22 Cu 16	1	1	4932464487	4058546224325
		25	10	L22 Cu 25	1	1	4932464488	4058546224332
		35	12	L22 Cu 35	1	1	4932464489	4058546224349
		50	14	L22 Cu 50	1	1	4932464490	4058546224356
		70	16	L22 Cu 70	1	1	4932464491	4058546224363
		95	18	L22 Cu 95	1	1	4932464492	4058546224370
		120	20	L22 Cu 120	1	1	4932464493	4058546224387
		150	22	L22 Cu 150	1	1	4932464494	4058546224394
		185	25	L22 Cu 185	1	1	4932464495	4058546224400
240	28	L22 Cu 240	1	1	4932464496	4058546224417		
⑦ Pre rounding of triangular shaped aluminium and copper conductors	Round	16	-	RU22 Cu/Al 16	1	1	4932451780	4002395276912
		35/25	-	RU22 Cu35/AL25	1	1	4932451781	4002395276929
		50/35	-	RU22 Cu50/AL35	1	1	4932451782	4002395276936
		70/50	-	RU22 Cu70/AL50	1	1	4932451783	4002395276943
		95/70	-	RU22 Cu95/AL70	1	1	4932451784	4002395276950
⑧ C taps	Oval	120/95	-	RU22 Cu120/AL95	1	1	4932451785	4002395276967
		150/120	-	RU22 Cu150/AL120	1	1	4932451786	4002395276974
		185/150	-	RU22 Cu185/AL150	1	1	4932451787	4002395276981
		240/185	-	RU22 Cu240/AL185	1	1	4932451788	4002395276998
		300/240	-	RU22 Cu300/AL240	1	1	4932451789	4002395277605
⑨ Crimping die box	Oval	10	-	C22 Cu 10/C4	1	1	4932464863	4058546228088
		16	-	C22 Cu 16/C5	1	1	4932464864	4058546228095
		25	-	C22 Cu 25/C6	1	1	4932464865	4058546228101
		35	-	C22 Cu 50/C8C9	1	1	4932464866	4058546228118

③



④

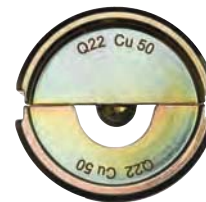

⑤



⑥



⑦



⑧



⑨



Crimping dies for M18[™] FORCE LOGIC[™] HCCT 109/42

Type	Form	Cable lug size (mm ²)	Imprint code	Description	Pack quantity	Min. order quantity	Article Number	EAN Code
① DIN Aluminium for aluminium compression cable lugs and connectors (DIN 46329, 46267 Part 1 und 2, DIN EN 50182)	Hex	16/25	12	DIN13 AL 16/25	1	1	4932459506	4058546026783
		35	14	DIN13 AL 35	1	1	4932459507	4058546026790
		50	16	DIN13 AL 50	1	1	4932459508	4058546026806
		70	18	DIN13 AL 70	1	1	4932459509	4058546026813
		95/120	22	DIN13 AL 95/120	1	1	4932459510	4058546026820
		150	25	DIN13 AL 150	1	1	4932459511	4058546026837
		185	28	DIN13 AL 185	1	1	4932459512	4058546026844
		240	32	DIN13 AL 240	1	1	4932459513	4058546026851
		300	34	DIN13 AL 300	1	1	4932459514	4058546026868
		② Copper tubular cable lugs and connectors like L series	Hex	16	8	L13 Cu 16	1	1
25	10			L13 Cu 25	1	1	4932464501	4058546224462
35	12			L13 Cu 35	1	1	4932464502	4058546224479
50	14			L13 Cu 50	1	1	4932464503	4058546224486
70	16			L13 Cu 70	1	1	4932464504	4058546224493
95	18			L13 Cu 95	1	1	4932464505	4058546224509
120	20			L13 Cu 120	1	1	4932464506	4058546224516
150	22			L13 Cu 150	1	1	4932464507	4058546224523
185	25			L13 Cu 185	1	1	4932464508	4058546224530
240	28			L13 Cu 240	1	1	4932464509	4058546224547
③ Pre rounding of triangular shaped aluminium and copper conductors	Round	16	-	RU13 Cu/Al16	1	1	4932459483	4058546011444
		35/25	-	RU13 Cu35/AL25	1	1	4932459484	4058546011451
		50/35	-	RU13 Cu50/AL35	1	1	4932459485	4058546011468
		70/50	-	RU13 Cu70/AL50	1	1	4932459486	4058546011475
		95/70	-	RU13 Cu95/AL70	1	1	4932459487	4058546011482
		120/95	-	RU13 Cu120/AL95	1	1	4932459488	4058546011499
		150/120	-	RU13 Cu150/AL120	1	1	4932459489	4058546011505
		185/150	-	RU13 Cu185/AL150	1	1	4932459490	4058546011512
		240/185	-	RU13 Cu240/AL185	1	1	4932459491	4058546011529
		300/240	-	RU13 Cu300/AL240	1	1	4932459492	4058546011536
④ Ferruls	Trapezoid	16	-	AEH13 Cu 16	1	1	4932459515	4058546026875
		25	-	AEH13 Cu 25	1	1	4932459516	4058546026882
		35	-	AEH13 Cu 35	1	1	4932459517	4058546026899
		50	-	AEH13 Cu 50	1	1	4932459518	4058546026905
		70	-	AEH13 Cu 70	1	1	4932459519	4058546026912
		95	-	AEH13 Cu 95	1	1	4932459520	4058546026929
		120	-	AEH13 Cu 120	1	1	4932459521	4058546026936
		150	-	AEH13 Cu 150	1	1	4932459522	4058546026943
		185	-	AEH13 Cu 185	1	1	4932459523	4058546026950
		240	-	AEH13 Cu 240	1	1	4932459524	4058546026967
⑤ C taps	Oval	16	-	C13 Cu 16	1	1	4932459525	4058546026974
		25	-	C13 Cu 25	1	1	4932459526	4058546026981
		35	-	C13 Cu 35	1	1	4932459527	4058546026998
		50	-	C13 Cu 50	1	1	4932459528	4058546027001
		70	-	C13 Cu 70	1	1	4932459529	4058546027018
		10	-	C13 Cu 10	1	1	4932459530	4058546027025
		10-35	-	C13 Cu 10-35	1	1	4932459531	4058546027032
		25-50	-	C13 Cu 25-50	1	1	4932459532	4058546027049
		35-70	-	C13 Cu 35-70	1	1	4932459533	4058546027056
		70	-	HAH13 Cu 70	1	1	4932459534	4058546027063
⑥ H clamps	Oval	95	-	HAH13 Cu 95	1	1	4932459535	4058546027070
		120	-	HAH13 Cu 120	1	1	4932459536	4058546027087
⑦ Double press cable shoes	Oval	2x50	-	DP13 Cu 2x50	1	1	4932459537	4058546027094
		2x70	-	DP13 Cu 2x70	1	1	4932459538	4058546027100
		2x95	-	DP13 Cu 2x95	1	1	4932459539	4058546027117
⑧ Crimping die box for M18 HCCT109/42 crimping (dies to be bought separately)					1	1	4932464211	4058546221560

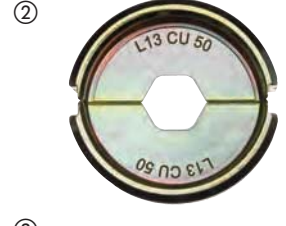
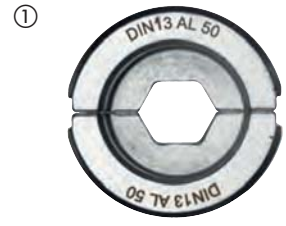

Crimping dies for M18™ HCCT 109/42

Type	Form	Cable lug size (mm ²)	Imprint code	Description	Pack quantity	Min. order quantity	Article Number	EAN Code
① NF C 20-130 for copper compression cable lugs	Hex	16	16	NF13 Cu 16	1	1	4932459453	4058546011147
		25	25	NF13 Cu 25	1	1	4932459454	4058546011154
		35	35	NF13 Cu 35	1	1	4932459455	4058546011161
		50	50	NF13 Cu 50	1	1	4932459456	4058546011178
		70	70	NF13 Cu 70	1	1	4932459457	4058546011185
		95	95	NF13 Cu 95	1	1	4932459458	4058546011192
		120	120	NF13 Cu 120	1	1	4932459459	4058546011208
		150	150	NF13 Cu 150	1	1	4932459460	4058546011215
		185	185	NF13 Cu 185	1	1	4932459461	4058546011222
		240	240	NF13 Cu 240	1	1	4932459462	4058546011239
		300	300	NF13 Cu 300	1	1	4932459463	4058546011246
		400	400	NF13 Cu 400	1	1	4932459464	4058546011253
② DIN 46235 for copper compression cable lugs and connectors (DIN 46267)	Hex	16	8	DIN13 Cu 16	1	1	4932459465	4058546011260
		25	10	DIN13 Cu 25	1	1	4932459466	4058546011277
		35	12	DIN13 Cu 35	1	1	4932459467	4058546011284
		50	14	DIN13 Cu 50	1	1	4932459468	4058546011291
		70	16	DIN13 Cu 70	1	1	4932459469	4058546011307
		95	18	DIN13 Cu 95	1	1	4932459470	4058546011314
		120	20	DIN13 Cu 120	1	1	4932459471	4058546011321
		150	22	DIN13 Cu 150	1	1	4932459472	4058546011338
		185	25	DIN13 Cu 185	1	1	4932459473	4058546011345
		240	28	DIN13 Cu 240	1	1	4932459474	4058546011352
③ Tubular cable lugs and connectors	Hex	300	32	DIN13 Cu 300	1	1	4932459475	4058546011369
		16	16	R13 Cu 16	1	1	4932459494	4058546011550
		25	25	R13 Cu 25	1	1	4932459495	4058546011567
		35	35	R13 Cu 35	1	1	4932459496	4058546011574
		50	50	R13 Cu 50	1	1	4932459497	4058546011581
		70	70	R13 Cu 70	1	1	4932459498	4058546011598
		95	95	R13 Cu 95	1	1	4932459499	4058546011604
		120	120	R13 Cu 120	1	1	4932459500	4058546011611
		150	150	R13 Cu 150	1	1	4932459501	4058546011628
		185	185	R13 Cu 185	1	1	4932459502	4058546011635
		240	240	R13 Cu 240	1	1	4932459503	4058546011642
		300	300	R13 Cu 300	1	1	4932459504	4058546026769
④ Copper solderless terminals (DIN 46234, DIN 46230, DIN 46341)	Half round indent	400	400	R13 Cu 400	1	1	4932459505	4058546026776
		16	16	Q13 CU 16	1	1	4932459477	4058546011383
		25	25	Q13 CU 25	1	1	4932459478	4058546011390
		35	35	Q13 CU 35	1	1	4932459479	4058546011406
		50	50	Q13 CU 50	1	1	4932459480	4058546011413
		70	70	Q13 CU 70	1	1	4932459481	4058546011420
		95	95	Q13 CU 95	1	1	4932459482	4058546011437

①



②

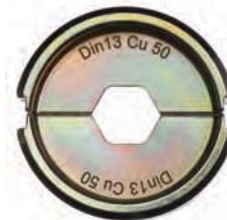

③



④



Crimp die kits

Description	Pack quantity	Min. order quantity	Article Number	EAN Code
DIN22 Cu die kit for M18 HCCT				
① Die storage box incl. 11 dies - 16, 25, 35, 50, 70, 95, 120, 150, 185, 240 & 300 mm ²	11	1	4932471997	4058546298968
DIN22 Al die kit for M18 HCCT				
② Die storage box incl. 9 dies - 16/25, 35, 50, 70, 95/120, 150, 185, 240 & 300 mm ²	9	1	4932471998	4058546298975
R22 Cu die kit for M18 HCCT				
③ Die storage box incl. 11 dies - 16, 25, 35, 50, 70, 95, 120, 150, 185, 240 & 300 mm ²	11	1	4932471999	4058546298982
DIN13 Cu die set for M18 HCCT109/42				
④ Die storage box incl. 11 dies - 16, 25, 35, 50, 70, 95, 120, 150, 185, 240 & 300 mm ²	11	1	4932472000	4058546323967
DIN13 Al die set for M18 HCCT109/42				
⑤ Die storage box incl. 9 dies - 16/25, 35, 50, 70, 95/120, 150, 185, 240 & 300 mm ²	9	1	4932472001	4058546323974
R13 Cu die set for M18 HCCT109/42				
⑥ Die storage box incl. 11 dies - 16, 25, 35, 50, 70, 95, 120, 150, 185, 240 & 300 mm ²	11	1	4932472002	4058546323981



Cable cutters - System attachments

Cable Cutter Blades suitable for M18[™] HCCAC / M18[™] HCCS

Description	Pack quantity	Min. order quantity	Article Number	EAN Code
① ACSR Aluminium steel reinforced cable cutting jaw including blades	1	1	49162773	045242350070
② ACSR Aluminium steel reinforced cable cutting blades	1	1	48440412	045242355235
① Cu/Al standard copper & aluminium cable cutting jaw including blades	1	1	4932430839	4002395385010
② Replacement cable cutter blades for copper and aluminium.	1	1	4932464498	4058546224431
① Armored cable cutting Jaw for M18 HCC	1	1	4932464867	4058546228125
② Replacement SWA blade for M18 HCC	1	1	4932464868	4058546228132
① FSW fine stranded wire cutting jaw including blades	1	1	49162778	045242505722
② FSW fine stranded wire cutting blades	1	1	48442778	045242505739
① EHS guy wire/steel wire cutting jaw including blades	1	1	49162777	045242505449
② EHS guy wire/steel wire cutting blades	1	1	48442777	045242505456



Cable cutting blades suitable for M18 HCCT

Description	Pack quantity	Min. order quantity	Article Number	EAN Code
Cu/Al standard Copper & Aluminum cable cutting jaw	1	1	4932464497	4058546224424



Cable cutter blades for underground cutter M18™ FORCE LOGIC™ HCC75

Description	Pack quantity	Min. order quantity	Article Number	EAN Code
Underground cutter blade M18 HCC75	1	1	49162774	045242486663



Cable cutter blades for M18™ FORCE LOGIC™ HCC45

Description	Pack quantity	Min. order quantity	Article Number	EAN Code
ACSR blade M18 HCC45	1	1	49162775	045242486632



Dies for M18BLTRC threaded rod cutter

Description	Pack quantity	Min. order quantity	Article Number	EAN Code
Dies for M18BLTRC threaded rod cutter	2	1	4932471372	4058546290009



M18 FUEL™ fish tapes - System attachments

Steel fish drums

Description	Pack quantity	Min. order quantity	Article Number	EAN Code
36 m x 3 mm steel fish drum	1	1	48445176	4058546326432
72 m x 3 mm steel fish drum	1	1	48445178	4058546326449



Non-conductive drums

Description	Pack quantity	Min. order quantity	Article Number	EAN Code
30 m non-conductive polyester drum	1	1	48445195	4058546326463
60 m non-conductive polyester drum	1	1	48445197	4058546326470



Pipe cutter / Cable cutter blades for M12™

Description	Pack quantity	Min. order quantity	Article Number	EAN Code
① Pipe cutter wheels. Suitable for copper pipe. Not suitable for plastic or stainless steel pipe	2	1	48380010	045242159710
② Cable cutter blade	1	1	4932430070	4002395377312
PEX cutter blade for C12 PPC	1	1	4931441978	4002395179268



Knockout punch - System attachments

Knockout punch and dies

Suitable for mild steel and aluminium up to a thickness of 3 mm.
Also suitable for stainless steel max. 2.5 mm.



Diameter (mm)	Standard PG size	Standard ISO metric size	Pack quantity	Min. order quantity	Punch		Die	
					Article Number	EAN Code	Article Number	EAN Code
16.2		M 16	1	1	4932430841	4002395385034	4932430913	4002395385751
20.4	PG 13.5	M 20	1	1	4932430842	4002395385041	4932430914	4002395385768
22.5	PG 16 1/2"		1	1	4932430843	4002395385058	4932430915	4002395385775
25.4		M 25	1	1	4932430844	4002395385065	4932430916	4002395385782
28.3	PG 21 1/2"		1	1	4932430845	4002395385072	4932430917	4002395385799
32.5		M 32	1	1	4932430846	4002395385089	4932430918	4002395385805
40.5		M 40	1	1	4932430847	4002395385096	4932430919	4002395385812
50.5		M 50	1	1	4932430848	4002395385102	4932430920	4002395385829
63.5		M 63	1	1	4932430849	4002395385119	4932430921	4002395385836

Draw stud bolt 49162680 (for 16.2 and 20.4 mm) Ø 11,1 mm: requires pre-drilling with Ø 11.3 - 11.5 mm drill bit / step drill.
Draw stud bolt 49162681 Ø 19 mm: requires pre-drilling with Ø 19.5 - 20 mm drill bit / step drill.

Description	Pack quantity	Min. order quantity	Article Number	EAN Code
Adaptor to allow the Milwaukee® tool to use competitors punches and dies ie. Klauke®, Greenlee® and Alfra®	1	1	49162685	045242337965

Hydraulic pump - System attachments

1.8 meter controller extension cord

Compatible with M18™ FORCE LOGIC™ hydraulic pump
IP 67 ingress protection for reliable use in the elements
Male-female connectors for interconnectable extension up to 7.3 m of length

Description	Pack quantity	Min. order quantity	Article Number	EAN Code
1.8 meter controller extension cord	1	1	49122775	4058546326487



Hydraulic oil

1 Liter accessory oil for M18™ FORCE LOGIC™ HUP700 hydraulic pump

Description	Pack quantity	Min. order quantity	Article Number	EAN Code
Replacement oil M18 HUP700	1	1	4932472004	4058546324001



Bucket hanger

Compatible with M18™ FORCE LOGIC™ hydraulic pump
Extendable bar & rubber bumpers allow for use with most existing buckets & steel baskets
Symmetrical lift ring design enable use from both sides of the hanger
Keeps pump in ideal, level operating position while freeing up space inside the bucket
Standard size lift rings allow for use with existing bucket hooks
Open frame design enables the user to open the pump battery door while still resting in the hanger

Description	Pack quantity	Min. order quantity	Article Number	EAN Code
Bucket hanger for M18 HUP700	1	1	49122776	045242535231



Expansion tools - System attachments







Expander heads

Description	Pipe diameter (mm)	Pipe wall thickness (mm)	Pipe pressure (bar)	Suitable	Pack quantity	Min. order quantity	Article Number	EAN Code
PXPH9-144/8	9.9	1.1	4/8	M12, M18	1	1	4932430102	4002395377633
PXPH12I-14	12	1.7/ 1.8/ 2	6-10	M12, M18	1	1	4932352716	4002395373741
PXPH15N-14	14 / 15	2.5	6-10	M12, M18	1	1	4932352727	4002395373857
PXPH16I-1406	16	1.5/ 1.8	6	M12, M18	1	1	4932430103	4002395377640
PXPH16I-1410	16	1.8/ 2.0/ 2.2	10	M12, M18	1	1	4932352717	4002395373758
PXPH18N-14	17 / 18	2.5	6-10	M12, M18	1	1	4932352728	4002395373864
PXPH20I-1406	20	1.9/ 2.0/ 2.3	6, (8 bar - Ø 2.3 mm)	M12, M18	1	1	4932352718	4002395373765
PXPH20I-1410	20	2.8	10	M12, M18	1	1	4932352719	4002395373772
PXPH20I-2506	20	1.9/ 2.0/ 2.3	6, (8 bar - Ø 2.3 mm)	M18	1	1	4932352733	4002395373918
PXPH20I-2510	20	2.8	10	M18	1	1	4932352748	4002395374069
PXPH22N-14	22	3	6-10	M12, M18	1	1	4932352729	4002395373871
PXPH25I-1406	25	2.3	6	M12, M18	1	1	4932352720	4002395373789
PXPH25I-1410	25	3.5	10	M12, M18	1	1	4932352721	4002395373796
PXPH25I-2506	25	2.3	6	M18	1	1	4932352722	4002395373802
PXPH25I-2510	25	3.5	10	M18	1	1	4932352749	4002395374076
PXPH28N-14	28	4	6-10	M12, M18	1	1	4932352730	4002395373888
PXPH32I-1406	32	2.9	6	M12, M18	1	1	4932352723	4002395373819
PXPH32I-25	32	2.9/ 4.4	6-10	M18	1	1	4932352724	4002395373826
PXPH40I-2506	40	3.7	6	M18	1	1	4932352725	4002395373833
PXPH 40I - 5606	40	3.7	6-10	M18 BLPXPL	1	1	4932451396	4002395160884
PXPH 50I - 5606	50	4.6	6-10	M18 BLPXPL	1	1	4932451397	4002395160891
PXPH 63I - 5606	63	5.8	6-10	M18 BLPXPL	1	1	4932451398	4002395158102
PXPH 75I - 5606	75	6.8	6-10	M18 BLPXPL	1	1	4932451399	4002395158119
Grease								
Tube contents 50 g. For lubrication of cone and expander heads					1	1	4932352726	4002395373840







Press tools - System attachments

Press jaws

Jaw profile	Fits to following pipe systems suppliers	Nominal size	Tool suitability	Jaw model description	Id. No. 4932-	EAN Code					
M	Geberit: Mapress VSH: X-Press Eurotubi Raccorderie Metallique Rubinetteria Bresciane Sanha: Nirosan Pegler Yorkshire	M12	M12	J12-M12	430243	4002395379040				 Jaw M profile	
		M12	M18	J18-M12	430244	4002395379057					
		M15	M12	J12-M15	430245	4002395379064					
		M15	M18	J18-M15	430246	4002395379071					
		M18	M12	J12-M18	430247	4002395379088					
		M18	M18	J18-M18	430248	4002395379095					
				M22	M12	J12-M22	430249	4002395379101			 Ring jaw M profile
				M22	M18	J18-M22	430250	4002395379118			
				M28	M12	J12-M28	430251	4002395379125			
				M28	M18	J18-M28	430252	4002395379132			
				M35	M12	J12-M35	430253	4002395379149			
				M35	M18	J18-M35	430254	4002395379156			
				M42	M18	RJ18-M42 (requires ring jaw adaptor RJA-1)	430255	4002395379163			
		M54	M18	RJ18-M54 (requires ring jaw adaptor RJA-1)	430256	4002395379170					
V	Viega Comap IBP Sanha: Nirosan	V12	M12	J12-V12	430260	4002395379217			 Jaw V profile		
		V12	M18	J18-V12	430261	4002395379224					
		V14	M12	J12-V14	451660	4002395273423					
		V14	M18	J18-V14	471086	4058546287146					
		V15	M12	J12-V15	430262	4002395379231					
		V15	M18	J18-V15	430263	4002395379248					
				V16	M12	J12-V16	451661	4002395273430			 Ring jaw V profile
				V16	M18	J18-V16	471087	4058546287153			
				V18	M12	J12-V18	430264	4002395379255			
				V18	M18	J18-V18	430265	4002395379262			
				V22	M12	J12-V22	430266	4002395379279			
				V22	M18	J18-V22	430267	4002395379286			
				V28	M12	J12-V28	430268	4002395379293			
				V28	M18	J18-V28	430269	4002395379309			
				V35	M12	J12-V35	430270	4002395379316			
				V35	M18	J18-V35	430271	4002395379323			
		V42	M18	RJ18-V42 (requires ring jaw adaptor RJA-1)	430272	4002395379330					
		V54	M18	RJ18-V54 (requires ring jaw adaptor RJA-1)	430273	4002395379347					
TH	ALB Comap Fränkische Henco (TH14 - TH25 only) IPA Sanha Tiemme	TH14	M12	J12-TH14	430274	4002395379354			 Jaw TH profile		
		TH14	M18	J18-TH14	430275	4002395379361					
		TH16	M12	J12-TH16	430276	4002395379378					
		TH16	M18	J18-TH16	430277	4002395379385					
		TH18	M12	J12-TH18	430278	4002395379392					
		TH18	M18	J18-TH18	430279	4002395379408					
				TH20	M12	J12-TH20	430280	4002395379415			 Ring jaw TH profile
				TH20	M18	J18-TH20	430281	4002395379422			
				TH25	M12	J12-TH25	430282	4002395379439			
				TH25	M18	J18-TH25	430355	4002395380169			
				TH26	M12	J12-TH26	430283	4002395379446			
				TH26	M18	J18-TH26	430284	4002395379453			
				TH32	M12	J12-TH32	430285	4002395379460			

Press jaws

Jaw profile	Fits to following pipe systems suppliers	Nominal size	Tool suitability	Jaw model description	Id. No. 4932-	EAN Code			
TH	ALB Comap Fränkische Henco (TH14 - TH25 only) IPA Sanha Tiemme	TH32	M18	J18-TH32	430286	4002395379477			
		TH40	M12	J12-TH40	430287	4002395379484			
		TH40	M18	RJ18-TH40 (requires ring jaw adaptor RJA-1)	430288	4002395379491			
		TH50	M18	RJ18-TH50 (requires ring jaw adaptor RJA-1)	430289	4002395379507			
		TH63	M18	RJ18-TH63 (requires ring jaw adaptor RJA-1)	430290	4002395379514			
U	ALB Uponor: Unipipe, Airpipe Kann: Kann-therm Wavin: Press-Systeme Fränkische: Alpex F50 Profi DW Verbundrohr: Multitubo IBP: >B< Flex KE Kelit: Kelit Kelox Jupiter: Heizsystem	U14	M12	J12-U14	430291	4002395379521			
		U14	M18	J18-U14	430292	4002395379538			
		U16	M12	J12-U16	430293	4002395379545			
		U16	M18	J18-U16	430294	4002395379552			
		U18	M12	J12-U18	430295	4002395379569			
		U18	M18	J18-U18	430296	4002395379576			
		U20	M12	J12-U20	430297	4002395379583			
		U20	M18	J18-U20	430298	4002395379590			
		U25	M12	J12-U25	430299	4002395379606			
		U25	M18	J18-U25	430300	4002395379613			
		U32	M12	J12-U32	430301	4002395379620			
		U32	M18	J18-U32	430302	4002395379637			
		U40	M12	J12-U40	430303	4002395379644			
		U40	M18	RJ18-U40 (requires ring jaw adaptor RJA-1)	430304	4002395379651			
U50	M18	RJ18-U50 (requires ring jaw adaptor RJA-1)	430305	4002395379668					
U63	M18	RJ18-U63 (requires ring jaw adaptor RJA-1)	430306	4002395379675					
ACz	ACOME MT	Acz12	M12	J12-ACz 12	459388	4058546010492			
		Acz16	M12	J12-ACz 16	459389	4058546010508			
		Acz20	M12	J12-ACz 20	459390	4058546010515			
		Acz25	M12	J12-ACz 25	459391	4058546010522			
G	Geberit: Mepla & Mepla Therm	G16	M12	J12-G16	464217	4058546221621			
		G16	M18	J18-G16	464544	4058546224899			
		G20	M12	J12-G20	464218	4058546221638			
		G20	M18	J18-G20	464545	4058546224905			
		G26	M12	J12-G26	464219	4058546221645			
		G26	M18	J18-G26	464546	4058546224912			
		G32	M12	J12-G32	464220	4058546221652			
		G32	M18	J18-G32	464547	4058546224929			
		G40	M12	J12-G40	464221	4058546221669			
		G40	M18	J18-G40	464548	4058546224936			
G50	M18	J18-G50	464549	4058546224943					
① Ring jaw adaptor				RJA-1	430307	4002395379682			① 

Drum machine attachments

Description	Fits drain cleaners M12B-DC6, M12-BDC8	Fits drain cleaners M18-FDCPF8, M18-FD-CPF10	Fits drain cleaners M18-FFSDC16, M18-FFSDC13, M18-FFS-DC10	Fits drain cleaners MXF-LSDP	Article Number	EAN Code
① 16 mm x 15.2 m open wind coupling end			✓		48532775	045242513109
6 mm x 7.6 m inner core bulb head	✓				48532573	045242471270
8 mm x 7.6 m inner core drop head	✓				48532572	045242364206
6 mm x 7.6 m inner core drop head	✓				48532574	045242471287
6 mm x 10.6 m inner core bulb head		✓			48532671	045242482740
6 mm x 15.2 m inner core bulb head		✓			48532672	045242482757
8 mm x 7.6 m inner core bulb head	✓				48532571	045242364213
② 8 mm x 10.6 m inner core bulb head		✓			48532673	045242482764
8 mm x 15.2 m inner core bulb head					48532674	045242482771
10 mm x 10.6 m inner core coupling end		✓			48532675	045242482788
6 mm x 7.6 m inner core bulb head drum	✓				48532581	045242480586
6 mm x 7.6 m inner core drop head drum	✓				48532582	045242480593
8 mm x 7.6 m inner core bulb head drum	✓				48532583	045242480609
8 mm x 7.6 m inner core drop head drum	✓				48532584	045242480616
8 mm x 23 m inner core bulb head			✓		48532772	045242513079
10 mm x 15.2 m inner core coupling end			✓		48532773	045242513086
13 mm x 15.2 m inner core coupling end			✓		48532774	045242513093
16 mm x 7.6 m inner core coupling end				✓	4932471701	4058546296001
16 mm x 15.2 m inner core coupling end				✓	4932471702	4058546296018
③ 20 mm x 7.6 m inner core coupling end				✓	4932471703	4058546296025
20 mm x 15.2 m inner core coupling end				✓	4932471704	4058546296032
16 mm anchor cable coupling end				✓	4932471707	4058546296063
16 mm x 60 cm leader cable coupling end				✓	4932471708	4058546296070
20 mm x 600 mm leader cable coupling end				✓	4932471709	4058546296087
④ Small bulb auger for 10, 13, 16 mm cables		✓	✓		48532681	045242503803
Small C cutter for 10, 13, 16 mm cables		✓	✓		48532684	045242503834
⑤ Medium C cutter for 10, 13, 16 mm cables					48532789	045242006137
75 mm chain knocker for 16, 20 mm cables				✓	48532837	4058546323448
⑥ 100 mm chain knocker for 16, 20 mm cables				✓	48532838	4058546323455
Small drop head for 10, 13, 16 mm cables		✓	✓		48532682	045242503810
⑦ Medium drop head for 10, 13, 16 mm cables		✓	✓		48532787	045242006113
Funnel auger for 16, 20 mm cables				✓	48532831	4058546323387
⑧ Medium funnel auger for 10, 13, 16 mm cables		✓	✓		48532786	045242006106
Small 5 pc head kit for 10, 13, 16 mm cables		✓	✓		48532685	045242503841
⑨ Medium 5 pc head kit for 10, 13, 16 mm cables		✓	✓		48532790	045242006144
9 pc head kit 16, 20 mm cables				✓	48532840	4058546296131
⑩ Small opening tool for 16, 20 mm cables				✓	48532835	4058546323424
Medium opening tool for 16, 20 mm cables				✓	48532836	4058546323431
75 mm root cutter for 16, 20 mm cables				✓	48532832	4058546323394
⑪ 100 mm root cutter for 16, 20 mm cables				✓	48532833	4058546323400
150 mm root cutter for 16, 20 mm cables				✓	48532834	4058546323417
Small spade bit for 10, 13, 16 mm cables		✓	✓		48532683	045242503827
⑫ Medium spade bit for 10, 13, 16 mm cables		✓	✓		48532788	045242006120
⑬ Straight auger for 16, 20 mm cables				✓	48532830	4058546323370
⑭ SWITCH PACK [™] auto feed for M18 FFSDC series			✓		4932471993	4058546298920
⑮ Guide hose for SWITCH PACK [™] auto feed			✓		4932471994	4058546298937
⑯ Base plate for SWITCH PACK [™] auto feed			✓		4932478225	4058546344023
⑰ SWITCH PACK [™] drum for M18 FFSDC series			✓		4932464277	4058546222222
⑱ Guide hose for MXFLSDP				✓	4932478110	4058546340421
⑲ Pin key for all cables		✓	✓	✓	4932471717	4058546296162



Sectional sewer machine attachments

Description	Fits sewer machine M18 FCSSM	Fits sewer machine M18 FSSM	Article Number	EAN Code
16 mm x 2.3 m open wind coupling end	✓		4932478413	4058546346041
16 mm x 2.3 m open wind inner core coupling	✓		4932478414	4058546346058
22 mm x 4.5 m open wind inner core coupling end	✓	✓	4932478415	4058546346065
① 22 mm x 4.5 m open wind coupling end	✓	✓	4932471712	4058546296117
22 mm x 4.5 m open wind coupling end kit	✓	✓	4932471713	4058546296124
32 mm x 4.5 m open wind coupling end		✓	4932471710	4058546296094
32 mm x 4.5 m open wind heavy duty coupling end		✓	4932471711	4058546296100
② Drop head bulb 16 mm cables	✓		48533811	4058546346126
Drop head straight 16 mm cables	✓		48533812	4058546346133
Funnel auger for 16 mm cables	✓		48533813	4058546346140
Small funnel auger for 22 mm cables	✓	✓	48533828	4058546346089
③ Medium funnel auger for 22 mm cables	✓	✓	48533831	4058546323479
Funnel auger for 32 mm cables		✓	48534831	4058546323561
Extra small opening tool for 16 mm cables	✓		48533814	4058546346157
Small opening tool for 16 mm cables	✓		48533815	4058546346164
Small opening tool for 22 mm cables	✓	✓	48533827	4058546346096
④ Small opening tool for 22 mm cables	✓	✓	48533835	4058546323516
Medium opening tool for 22 mm cables	✓	✓	48533836	4058546323523
Small opening tool for 32 mm cables		✓	48534835	4058546323608
Medium opening tool for 32 mm cables		✓	48534836	4058546323615
Spring cleaner for 16 mm cables	✓		48533816	4058546346171
⑤ Spring cleaner for 22 mm cables	✓	✓	48533826	4058546346102
50 mm root cutter for 22 mm cables	✓	✓	48533825	4058546346119
75 mm root cutter for 22 mm cables	✓	✓	48533832	4058546323486
100 mm root cutter for 22 mm cables	✓	✓	48533833	4058546323493
⑥ 150 mm root cutter for 22 mm cables	✓	✓	48533834	4058546323509
75mm root cutter for 32 mm cables		✓	48534832	4058546323578
100 mm root cutter for 32 mm cables		✓	48534833	4058546323585
150 mm root cutter for 32 mm cables		✓	48534834	4058546323592
Small straight auger for 22 mm cables	✓	✓	48533829	4058546346072
⑦ Medium straight auger for 22 mm cables	✓	✓	48533830	4058546323462
Straight auger for 32 mm cables		✓	48534830	4058546323554
75 mm chain knocker for 22 mm spirals	✓	✓	48533837	4058546323530
⑧ 100 mm chain knocker 22 mm cables	✓	✓	48533838	4058546323547
75 mm chain knocker for 32 mm spirals		✓	48534837	4058546323622
100 mm chain knocker 32 mm cables		✓	48534838	4058546323639
⑨ 9pc head kit for 22 mm cables	✓	✓	48533840	4058546296148
9pc head kit for 32 mm cables		✓	48534839	4058546296155
Small guide hose for FCSSM	✓		4932478410	4058546346010
⑩ Medium guide hose for FCSSM	✓		4932478409	4058546346003
Large guide hose for FSSM		✓	4932471720	4058546296193
Cable drum for 16mm spirals	✓		4932478412	4058546346034
⑪ Cable drum for 22mm spirals	✓	✓	4932478411	4058546346027
Cable drum for 32mm spirals		✓	4932471719	4058546296186
⑫ Pin key for all cables	✓	✓	4932471717	4058546296162

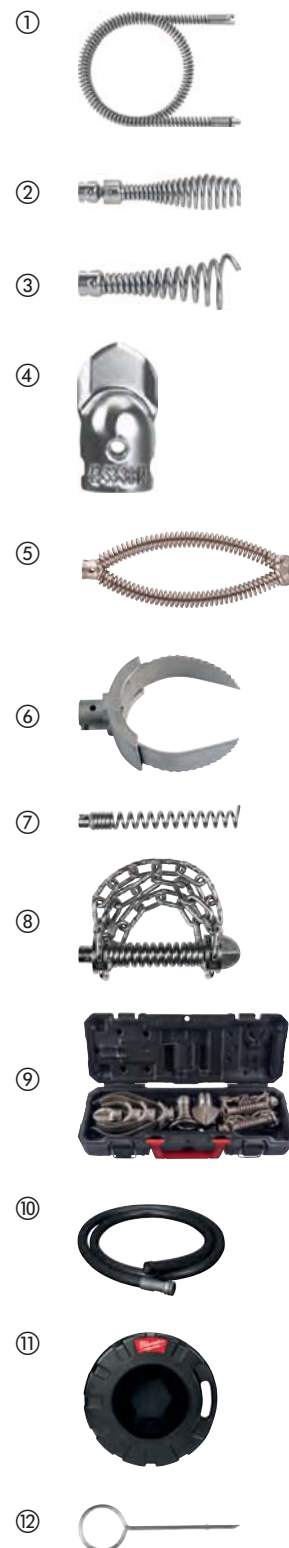

Inspection cameras

All extension cables are water splash and dust proof.

Extensions are attached between the base camera unit and standard supplied camera cable.

Description	Cable length (m)	Cable diameter (mm)	Fits inspection cameras	Pack quantity	Min. order quantity	Article Number	EAN Code
Cable extension: Up to a maximum of 3 extensions can be fixed together	0.9	17	C12 IC	1	1	48530110	045242157747
① Cable extension: Up to a maximum of 5 extensions can be fixed together	0.9	17	C12 AVD, C12 AVA	1	1	48530141	045242216529
Replacement analog camera cable	0.9	9.5	C12 AVD, C12 AVA	1	1	4931419517	4002395828234
1m replacement cable camera for the M-spector camera	1	12	M12 IC AV3	1	1	48530150	045242344208
3m replacement cable camera for the M-spector camera	3	12	M12 IC AV3	1	1	48530151	045242344222
② 1 m articulating cable	1	12	M12 IC AV3	1	1	48530155	045242344215
③ Skid set for M18 [™] SIC36	-	-	M18 SIC36	1	1	4931473616	4058546354923
④ Skid set for M18 [™] SIC60	-	-	M18 SIC60	1	1	4931473638	4058546355142
⑤ Grounding kit for M18 [™] SISH	-	-	M18 SISH	1	1	4931473526	4058546354022

①



②



③



④



⑤



Caulk guns - System attachments

Description	Fits caulk guns	Pack quantity	Min. order quantity	Article Number	EAN Code
① 310 ml standard carriage. Accepts all standard 250 ml and 310 ml tubes/cartridges Includes plunger rod assembly (4932352937), piston for carriage assemblies and a feed screw (44700330)	C18 PCG	1	1	48081076	045242263127
② 310 ml standard carriage. Accepts all standard 250 ml and 310 ml tubes/cartridges Includes plunger rod assembly (4932430099), piston for carriage assemblies and a feed screw (44700330)	C12 PCG	1	1	48080900	045242286355
③ 310 ml aluminium sausage tube barrel. Accepts standard 310 ml "sausage style" material packs and 380 ml cartridges. Requires plunger rod 49520660	PCG 14 / 300, PCG 14 / 600	1	1	48081085	045242089246
④ 400 ml aluminium sausage tube barrel. Accepts standard 400 ml "sausage style" material packs (includes 2 end cups). Requires plunger rod (48091090) and piston (44700375)	C18 PCG, C12 PCG	1	1	4932352844	4002395375028
⑤ 600 ml aluminium sausage tube barrel. Accepts standard 600 ml "sausage style" material packs (includes 2 end cups). Requires plunger rod (48091091) and piston (44700375)	C18 PCG, C12 PCG	1	1	4932352845	4002395375035
⑥ 400 ml transparent sausage tube barrel. Accepts standard 400 ml "sausage style" material packs (includes 2 end cups). Requires plunger rod (48091090) and piston (44700375)	C18 PCG, C12 PCG	1	1	4932352842	4002395375004
⑦ 600 ml transparent sausage tube barrel. Accepts standard 600 ml "sausage style" material packs (includes 2 end cups). Requires plunger rod (48091091) and piston (44700375)	C18 PCG, C12 PCG	1	1	4932352843	4002395375011
⑧ Plunger rod assembly for 310 ml cartridges. For use with: 48081076 310 ml standard carriage	C18 PCG	1	1	4932352937	4002395375950
⑨ Plunger rod assembly for 310 ml carriage. For use with: 48080900 310 ml standard carriage	C12 PCG	1	1	4932430099	4002395377602
⑩ Plunger rod short (340 mm long). For use with: 48081075 carriage and 48081085 "sausage style" barrel	PCG 14 / 300, PCG 14 / 600	1	1	49520600	045242190201
⑪ Plunger rod assembly for 400 ml sausage tube barrel. For use with: 4932352844 400 ml aluminium sausage tube barrel. 4932352842 400 ml transparent sausage tube barrel	C18 PCG	1	1	48091090	045242263158
⑫ Plunger rod assembly for 400 ml sausage tube barrel. For use with: 4932352844 400 ml aluminium sausage tube barrel. 4932352842 400 ml transparent sausage tube barrel	C12 PCG	1	1	4932430100	4002395377619
⑬ Plunger rod assembly for 600 ml sausage tube barrel. For use with: 4932352845 600 ml aluminium sausage tube barrel. 4932352843 600 ml transparent sausage tube barrel	C18 PCG	1	1	48091091	045242263165
⑭ Plunger rod assembly for 600 ml sausage tube barrel. For use with: 4932352845 600 ml aluminium sausage tube barrel. 4932352843 600 ml transparent sausage tube barrel	C12 PCG	1	1	4932430101	4002395377626
⑮ Piston for carriage assemblies	C18 PCG, C12 PCG	1	1	44700330	045242260928
⑯ Piston for sausage tube barrels	C18 PCG, C12 PCG	1	1	44700375	045242277438
⑰ Replacement nozzle	PCG 14 / 300, PCG 14 / 600, C18 PCG, C12 PCG	1	1	45760525	4002395775323

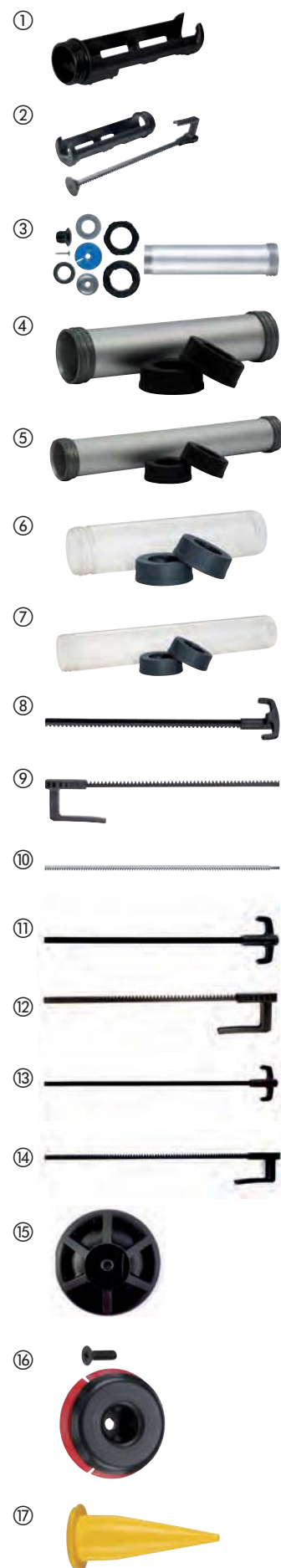

Electrical Test & Measuring - System attachments

Description	Pack quantity	Min. order quantity	Article Number	EAN Code
① Electrical test probes (max. 1000 Volts/ 10 Amps) heads 125 mm long	1	1	49771004	045242238965
② Electrical alligator clips (max. 1000 Volts/ 10 Amps)	1	1	49771005	045242238972



Heated jackets - System attachments

M18[™] USB Power Source - M18[™] USB PS HJ. Powers the jacket on M18[™] battery packs. USB charging port for MP3 player, mobile phone, digital camera, GPS.

12 V Car Plug - 12 V CP HJ. Powers the jacket on any 12 V cigarette style outlet.

Description	Pack quantity	Min. order quantity	Article Number	EAN Code
① M18 [™] 2.1A USB controller (M18 USB PS HJ2)	1	1	4932471597	4058546294960
② M12 [™] car plug (12 V CP HJ)	1	1	4932430085	4002395377466



M12™ / M18™ dust absorption system

Description	Fits Milwaukee dust absorption systems	Pack quantity	Min. order quantity	Article Number	EAN Code
① Drilling nozzle	M18 CDEX / M18/28 CPDEX, M12 DE	2	1	49902301	045242337279
② Filter	M18 CDEX / M18/28 CPDEX, M12 DE	3	1	49902306	045242299454
③ Crevice nozzle	M12 DE	1	1	49902325*	045242297603
④ Filter set (3pc) Filter box, filter, box lid	M12 DE	3	1	49902340	045242299461
⑤ M18 & M28 Dustbox with filter box, filter	M18 CDEX / M18/28 CPDEX	4	1	49902342	045242341948
⑥ Dust thru-box to allow connection of the M12 DE to an independent dust extraction / vacuum cleaner. Outlet nozzle: Ø 37 mm outside / Ø 32 mm inside		1	1	4932430479	4002395381401
Drilling shroud - PHDE152. For drilling and dry coring from Ø 25 - 152 mm. Brush insert to improve suction and extraction.		1	1	4932471990	4058546298890

①



②



③



④



⑤



⑥



Dust absorption solutions - System attachments

Vacuum cleaners

	Description	Fits MILWAUKEE® dust absorption systems	Pack quantity	Min. order quantity	Article Number	EAN Code
①	Extraction hose, anti static, 4 m long 36 mm diameter with tool adaptor	AS 300 ELCP, AS 500 ELCP, AS 300 EMAC	1	1	4932352311	4002395369706
②	Extraction hose, 3.5 m long 32 mm diameter with tool adaptor	AS 250 ECP	1	1	4932352312	4002395369713
③	Adaptor for direct connection of suction hose 330552	AS 1, AS 2 C	1	1	4932430833	4002395384952
④	Universal adaptor Ø 35 / 33 / 27 mm	WDC 1400 A, AS 1, AS 2 C, AS 3 W, ASE 1400, ASM 1400	1	1	4932369282	4002395338412
⑤	Ø 35 mm suction tube 50 cm plastic	ASE 1400, AS 1, AS 2 C, ASM 1400	1	1	4932346620	4002395319503
⑥	Extraction hose Ø 35 mm / 5 m	ASE 1400, ASM 1400	1	1	4932373626	4002395351534
⑦	Ø 50 mm wide gap nozzle.	ASE 1400, AS 1, AS 2 C, ASM 1400	1	1	4932316070	4002395310449
⑧	Ø 50 mm to Ø 35 mm reduction sleeve	ASE 1400, AS 1, AS 2 C, ASM 1400	1	1	4932316074	4002395310456
⑨	5 x 25 l fleece filter bags	AS 250 ECP	5	1	4932352306	4002395369652
⑩	5 x 30 l fleece filter bags	AS 300 ELCP, AS 300 EMAC, AS 300 ELAC	5	1	4932352307	4002395369669
⑪	5 x 50 l fleece filter bags	AS 500 ELCP	5	1	4932352308	4002395369676
⑫	Filter bags: 5 x plastic bags, 30 l	AS 250 ECP, AS 300 ELCP, AS 300 EMAC	5	1	4932352309	4002395369683
⑬	Filter bags: 5 x plastic bags, 50 l	AS 500 ELCP	5	1	4932352310	4002395369690
⑭	Filter bags. Heavy duty 3 x 18 l paper bags	NT 1500 A	1	1	4932373669*	4002395351824
⑮	Filter bags. Heavy duty 5 x 25 l paper bags	RSE 1400	5	1	4932373852	4002395352821
⑯	Filter bags. Heavy duty 5 x 50 l paper bags	ASE 1400, ASM 1400	5	1	4932373621	4002395351503
⑰	Fleece filter bags for AS 30/42	AS 30 LAC, AS 30 MAC, AS 42 MAC	5	1	4932459689	4058546028619
⑱	Disposable bags 30 l	AS 42 MAC, AS 30 MAC, AS 30 LAC	5	1	4932459690	4058546028626
⑲	Filter cartridge	AS 250 ECP, AP 250 ECP	1	1	4932352303	4002395369621
⑳	Filter cartridge	AS 300 ELCP, AS 500 ELCP, AS 2-250 ELCP	1	1	4932352304	4002395369638
㉑	Filter cartridge	AS 300 EMAC, AS 300 ELAC	2	1	4932352305	4002395369645
㉒	Filter cartridge, 7000 cm ² , BIA usage Cat. C	AS 3 W	1	1	4932346588*	4002395319473
㉓	Flat folded polyester filter cartridge, 2 pcs	ASE 1400, ASM 1400	1	1	4932373623	4002395351510
㉔	PTFE flat filter	AS 30 LAC, AS 42 MAC, AS 30 MAC	1	1	4932459687	4058546028596
㉕	Motor cooling filter	AS 42 MAC, AS 30 MAC, AS 30 LAC	1	1	4932459688	4058546028602
㉖	Metal push handle	AS 42 MAC, AS 30 MAC, AS 30 LAC	1	1	4932459691	4058546028633

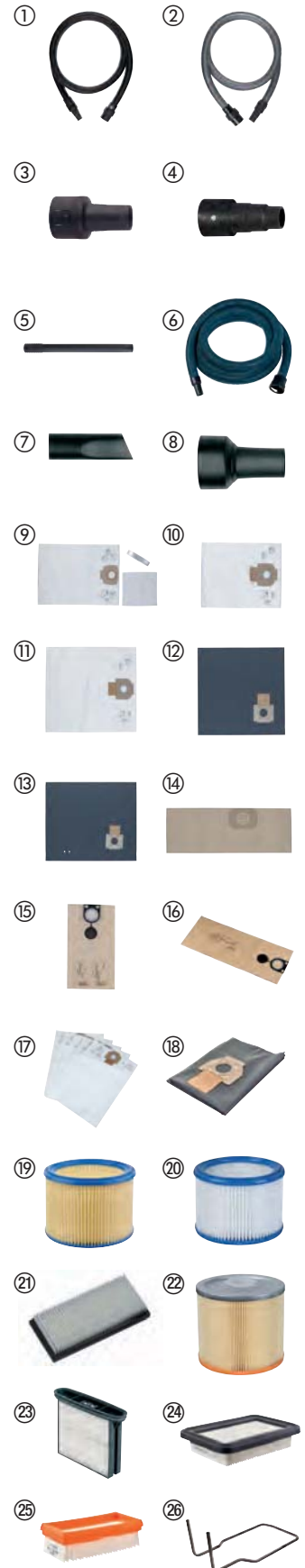



TID-extra
Industrial Technologies d.o.o.

HAND TOOLS

Hand Tools

Tape measures **STUD™ II**



- EXO 360™ blade technology delivers long lasting, rip and wear resistance.
- Strong magnet at start of the tape allows easy hooking onto flat surfaces and round pipe.
- Up to 4 m stand out - higher stand out for higher efficiency and higher reach.
- Anti-tear coating - reinforces the first 15 cm of the blade.
- 2 sided blade printing - increases the readability.
- Patented finger stop - protects fingers from blade retraction.
- ABS housing with impact resistant overmold for more comfort and jobsite durability.
- Wire form belt clip - reduces pocket tearing.
- Tool lanyard hole - Ready for quick and easy tethering.
- Class II accuracy.

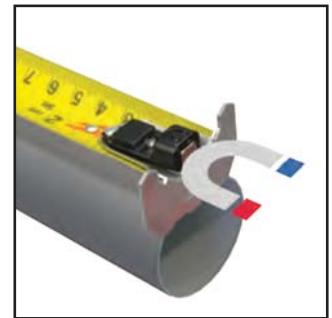

Strong magnet

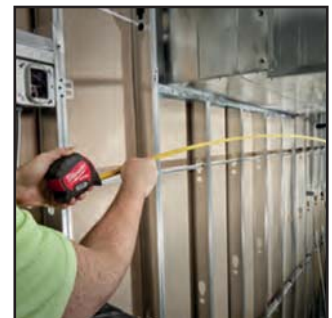

4M STANDOUT

Description	Length (m)	Blade width (mm)	Pack quantity	Min. order quantity	Article Number	EAN Code
STUD Gen2 5 m	5	33	1	6	4932471626	4058546295257
STUD Gen2 8 m	8	33	1	6	4932471627	4058546295264
STUD Gen2 5 m 16 ft	5 / 16'	33	1	6	4932471628	4058546295271
STUD Gen2 8 m 26 ft	8 / 26'	33	1	6	4932471629	4058546295288



Premium wide blade tape measures

- Up to 4 m standout - higher standout for higher efficiency and higher reach.
- Anti-tear coating - reinforces the first 15 cm of the blade.
- 2 sided blade printing - increases the readability.
- Impact resistant 5 points - reinforces the frame and makes it more durable.
- Patented finger stop - protects fingers from blade retraction.
- Wire form belt clip - reduces pocket tearing.
- Nylon bond blade protection - reduces tape tear.
- Tool lanyard hole - Ready for quick and easy tethering.



4M STANDOUT



Description	Length (m)	Blade width (mm)	Pack quantity	Min. order quantity	Article Number	EAN Code
Premium Wide Blade 5 m	5	33	1	6	4932471815	4058546297145
Premium Wide Blade 8 m	8	33	1	6	4932471816	4058546297152
Premium Wide Blade 5 m 16 ft	5 / 16'	33	1	6	4932471817	4058546297169
Premium Wide Blade 8 m 26 ft	8 / 26'	33	1	6	4932471818	4058546297176

Magnetic tape measures GEN III



- Strong magnet at start of the tape allows easy hooking onto flat surfaces and round pipe.
- Compact and ergonomic design.
- Improved standout up to 3.4 m.
- Nylon non-reflective bond blade protection, up to 10x more resistant to jobsite damage.
- 27 mm blade with double sided printing on tape for easier readability.
- Patented finger stop: stable when stands alone.
- 5-point reinforced frame for jobsite durability.
- Class II accuracy.
- Architect scale provides easy calculating of scaled drawings.



Description	Length (m)	Blade width (mm)	Pack quantity	Min. order quantity	Article Number	EAN Code
Magnetic Tape Measure 5 m	5	27	1	6	4932464599	4058546225445
Magnetic Tape Measure 8 m	8	27	1	6	4932464600	4058546225452
Magnetic Tape Measure 10 m	10	27	1	6	4932464601	4058546225469
Magnetic Tape Measure 5 m - 16 ft	5 / 16'	27	1	6	4932464602	4058546225476
Magnetic Tape Measure 8 m - 26 ft	8 / 26'	27	1	6	4932464603	4058546225483



Tape measure Autolock

- Autolock brake: tape automatically locks in place as blade is pulled out.
- Nylon coated blade protection against debris, dirt and water.
- 5 Point reinforced housing for outstanding tape lifetime.
- ABS housing with impact resistant overmold for more comfort and jobsite durability.
- Compact design and comfortable size.
- Heavy Duty belt clip.
- Class II accuracy.
- Bulk packed, order in multiples of 6pcs.



Description	Length (m)	Blade width (mm)	Pack quantity	Min. order quantity	Article Number	EAN Code
Tape measure Autolock 5 m	5	25	1	6	4932464663	4058546226084
Tape measure Autolock 8 m	8	25	1	6	4932464664	4058546226091
Tape measure Autolock 5 m - 16 ft	5	25	1	6	4932464665	4058546226107
Tape measure Autolock 8 m - 26 ft	8	25	1	6	4932464666	4058546226114



Tape measures pro compact

- Improved ergonomics and comfortable size.
- Jobsite durability.
- 5-point reinforced housing.
- 2G nylon coated blade protection.
- Improved tape tear and flexibility.
- Withstands 3 m drop test.
- Non magnetic.
- Heavier font on measurements for better readability.
- Smaller compact hook design.
- Back rest for easy vertical measuring.
- Improved belt clip: more pocket friendly.



Description	Length (m)	Blade width (mm)	Pack quantity	Min. order quantity	Article Number	EAN Code
Tape measure pro compact C3/16	3	16	1	12	4932459591	4058546027636
Tape measure pro compact C5/19	5	19	1	12	4932459592	4058546027643
Tape measure pro compact C5/25	5	25	1	6	4932459593	4058546027650
Tape measure pro compact C8/25	8	25	1	6	4932459594	4058546027667
Tape measure pro compact C5-16/25	5 / 16'	25	1	24	4932459595	4058546027674
Tape measure pro compact C8-26/25	8 / 26'	25	1	12	4932459596	4058546027681



Tape measure with LED Light

- 19 LUX LED Light: helps finding measured spot.
- Nylon lacquer blade protection against debris, dirt and water.
- 4 Point reinforced housing for outstanding tape lifetime.
- ABS housing with impact resistant overmold for more comfort and jobsite durability.
- Compact design and comfortable size.
- Magnet on the rear side of the tape for attaching to metal tool boxes and other metal surfaces.
- 2x CR2016 batteries are included in the delivery scope.
- Class II accuracy.
- Bulk packed, order in multiples of 12 pcs.



Description	Length (m)	Blade width (mm)	Pack quantity	Min. order quantity	Article Number	EAN Code
-------------	------------	------------------	---------------	---------------------	----------------	----------

3m/10ft tape measure with LED	3	12	1	12	48226602	045242529285
-------------------------------	---	----	---	----	----------	--------------



Tape measures slimline

- Very compact and improved ergonomic design.
- Nylon coated blade protection against debris, dirt and water.
- ABS housing with softgrip rubber gripping area for extra comfort and jobsite durability.
- 4-point reinforced frame.
- Flat base for horizontal stability and back rest for easy vertical measuring.
- Belt clip.
- Class II accuracy.
- Orders are only possible in master cartons with 24, 12 or 6 tapes depending on sku.



Description	Length (m)	Blade width (mm)	Pack quantity	Min. order quantity	Article Number	EAN Code
-------------	------------	------------------	---------------	---------------------	----------------	----------

S3 / 16	3	16	1	12	48227703	045242512898
S5 / 19	5	19	1	12	48227705	045242512904
S5 / 25	5	25	1	6	48227706	045242512911
S8 / 25	8	25	1	6	48227708	045242512928
S5-16 / 25	5/16'	25	1	24	48227717	045242512935
S8-26 / 25	8/26'	25	1	24	48227726	045242512942



Tape measure - 2 m / 6 ft



- 5-point reinforced frame for job site durability.
- Heavy duty blade with 13 mm blade width.
- Double sided nylon bond blade protection for extreme tape durability against dust, dirt, debris and water.
- Compact design and overmould gripping area for extra comfort and durability.
- Bulk packed, order in multiples of 12 pcs.

Description	Length (m)	Pack quantity	Min. order quantity	Article Number	EAN Code
2 m/6 ft metric & imperial tape measure	2	1	12	48225502	045242468034

Composite folding rule

- Locks at 90°/180°.
- Angle reference, rust free.
- Water resistant.
- Wear resistant markings.



Description	Length (m)	Blade width (mm)	Accuracy	Links	Hinge	Pack quantity	Min. order quantity	Article Number	EAN Code
Composite folding rule	2	15 x 3.20	Class 2	10	Plastic and stainless steel	1	10	4932459301	4058546002671

Wood folding rule

- Locks at 90°/180°.
- Angle reference.



Description	Length (m)	Blade width (mm)	Accuracy	Links	Hinge	Pack quantity	Min. order quantity	Article Number	EAN Code
Wood folding rule	2	16 x 3.20	Class 3	10	Brass	1	12	4932459302	4058546002688

Slim wood folding rule

- Locks at 180°.
- Flexible slim design.



Description	Length (m)	Blade width (mm)	Accuracy	Links	Hinge	Pack quantity	Min. order quantity	Article Number	EAN Code
Slim wood folding rule	2	16 x 2.70	Class 3	10	Brass	1	10	4932459303	4058546002695

Long open tapes

- Steel blade design with nylon clad (extra thick nylon coating) for increased durability.
- Best in class stretch performance: up to 50% less stretch vs. fiberglass tapes.
- Ultra durable design: reinforced metal handle and drop durability.
- 3:1 clutched planetary gearing for 10x longer gear durability and smooth rewind.
- GRIME GUARD: debris wiper keeps blade clean and clear of abrasive material.
- Class II accuracy.
- 2 sided scale printing. Metric measurements shown on the top side and imperial (inches and feet) on the underside of the blade.



Description	Length (m)	Blade width (mm)	Pack quantity	Min. order quantity	Article Number	EAN Code
① Long open tape combi 30m/100ft	30	13	1	1	48225203	045242486069
② Long open tape combi 100m/330ft	100	9.5	1	1	48225211	045242486076

Fibreglass long tapes

- Fibreglass blade ensures a low tape weight
- 3:1 clutched planetary gearing for 10x longer gear durability and smooth rewind.
- GRIME GUARD: debris wiper keeps blade clean and clear of abrasive material.
- 2 sided scale printing. Metric measurements shown on the top side and imperial (inches and feet) on the underside of the blade.



Description	Length (m)	Blade width (mm)	Pack quantity	Min. order quantity	Article Number	EAN Code
① Fibreglass long tape combi 30m/100ft	30	13	1	1	48225330	045242527731
② Fibreglass long tape combi 60m/200ft	60	13	1	1	48225360	045242527748

Long closed tapes

- Single sided 30 m metric tape with 9.5 mm blade width.
- GRIME GUARD: debris wiper keeps blade clean and clear of abrasive material.
- Ultra durable design: reinforced metal frame housing, reinforced handle and steel blade with nylon coating.
- 3:1 clutched planetary gearing for 10x longer gear durability and smooth rewind.
- Class II accuracy



Description	Length (m)	Blade width (mm)	Pack quantity	Min. order quantity	Article Number	EAN Code
Long closed tape 30m	30	9.5	1	1	48225103	045242486106



Nothing but **HEAVY DUTY**.™

REDSTICK™ DIGITAL LEVELS

NEW

**REDLITHIUM™
USB**

HEAVY DUTY DESIGN

- Increased frame and strength
- 2x stronger display
- IP65 rating

BEST USER EXPERIENCE

- Enhanced visual and audio signals
- AUTO MODE - Screen automatically adjusts to the environment based on the amount of light

PRECISION ACCURACY

- PIN MODE - Quickly set and save any measurement with 360°
- DYNAMIC READOUT - Delivers enhanced graphics when approaching the target
- Accurate to: 0°, 90%/0.03° and 1°-89%/10

TiD-extra
Industrial Technologies d.o.o.



**REDLITHIUM™
USB RECHARGEABLE
BATTERY PROVIDES
ALL DAY RUN TIME**



Digital levels



Description	Length (cm)	Handles	Pack quantity	Min. order quantity	Article Number	EAN Code
Digital level 60 cm	60	0	1	1	4933471978	4058546298777
Digital level 120 cm	120	2	1	1	4933471979	4058546298784

Expandable level



- Cover any length from 200 cm - 366 cm with laser etched measurements.
- SHARPSITE™ vial technology improves the readability of the vial.
- Reinforced internal components protect the level from damage or wear.
- Precision milled measuring surface provides accuracy in all working positions.
- Accurate to 0.029° (0.0005 "/in, 0.5 mm/m) In normal and reverse position.
- High contrast vial system is easy to clean and optimises visibility.
- Full grip frame for improved ergonomics in transport & application.
- Secure tool-removable stand offs.



Description	Length (cm)	Handles	Pack quantity	Min. order quantity	Article Number	EAN Code
Expandable 200cm - 366cm	200 - 366	2	1	1	4932471355	4058546289836

30 YEARS ACCURACY GUARANTEE
 JAHRE GENAUIGKEITSGARANTIE
 ANS DE PRECISION GARANTIE
www.milwaukeetool.eu





Nothing but **HEAVY DUTY.**[™]

REDSTICK[™]

DURABLE. GUARANTEED ACCURACY.



TID-extra
Industrial Technologies

1

Shock absorbing end caps protect the frame.

2

Durable, All-Metal Hang Hole for storage

3

Wide, durable handles for comfort and portability

4

High Contrast Vial System is easy to clean and optimizes visibility

5

Over-moulded, non-slip grips stick to the wall and prevent sliding

6

Precision milled measuring surface guarantees accuracy in all working positions



SHARPSITE[™] VIAL TECHNOLOGY
IMPROVED Readability



ALL-METAL REINFORCED BACKBONE[™]



AMPLIFIED RARE-EARTH MAGNETS

REDSTICK™ BACKBONE™ box levels



- All-metal BACKBONE™. Strong and durable frame. Reinforced vial retention.
- SHARPSITE™ vial technology improves the readability of the vial.
- Wide, durable handles for comfort and portability.
- Precision milled measuring surface provides accuracy in all working positions.
- High contrast vial system is easy to clean and optimises visibility.
- Shock absorbing end caps protect the frame.
- Overmolded, non-slip grips stick to the wall and prevent sliding.
- Durable, all-metal hang hole for storage.
- Accurate to 0.029° (0.0005 ʹ/in, 0.5 mm/m) In normal and reverse position.
- Amplified rare earth magnets for maximum holding power (only magnetic levels).



Strong and durable frame, all metal reinforced BACKBONE™



SHARPSITE™ vial technology improves the readability of the vial



Amplified rare earth magnets for maximum holding power (only magnetic levels)

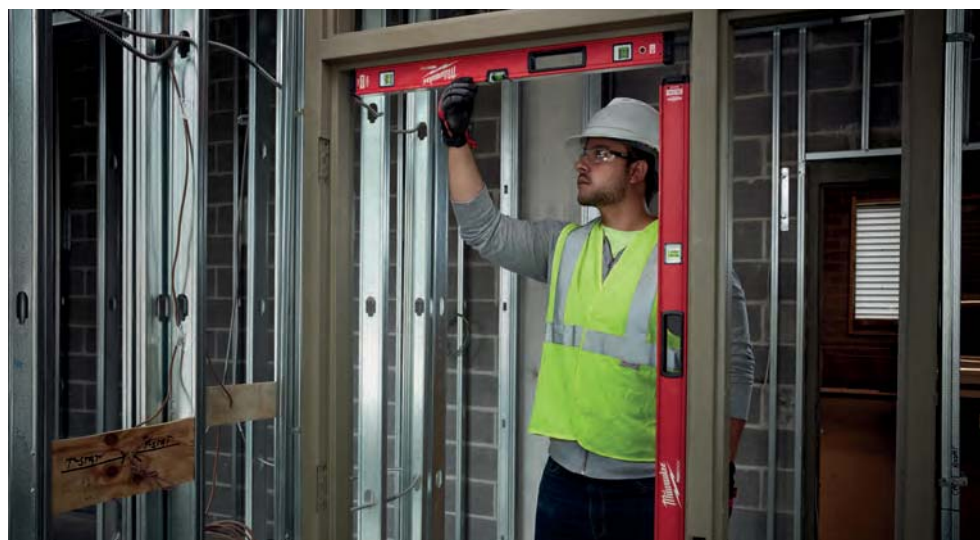

30 YEARS ACCURACY GUARANTEE
 JAHRE GENAUIGKEITSGARANTIE
 ANS DE PRECISION GARANTIE
www.milwaukeetool.eu

Description	Length (cm)	Handles	Pack quantity	Min. order quantity	Article Number	EAN Code
40 cm magnetic	40	0	1	1	4932459061	4002395280322
60 cm magnetic	60	0	1	1	4932459063	4002395280346
80 cm magnetic	80	1	1	1	4932459065	4002395280360
100 cm magnetic	100	0	1	1	4932459067	4002395280384
120 cm magnetic	120	2	1	1	4932459069	4002395281008
180 cm magnetic	180	2	1	1	4932459071	4002395281046
200 cm magnetic	200	2	1	1	4932459073	4002395281060
240 cm magnetic	240	2	1	1	4932459075	4002395281084
40 cm non-magnetic	40	0	1	1	4932459060	4002395280315
60 cm non-magnetic	60	0	1	1	4932459062	4002395280339
80 cm non-magnetic	80	1	1	1	4932459064	4002395280353
100 cm non-magnetic	100	0	1	1	4932459066	4002395280377
120 cm non-magnetic	120	2	1	1	4932459068	4002395280391
180 cm non-magnetic	180	2	1	1	4932459070	4002395281015
200 cm non-magnetic	200	2	1	1	4932459072	4002395281053
240 cm non-magnetic	240	2	1	1	4932459074	4002395281077
End-caps for REDSTICK™ BACKBONE™ levels			2	1	4932459680	4058546028527

REDSTICK[™] compact box levels



- SHARPSITE[™] vial technology improves the readability of the vial.
- Compact and durable frame.
- Bottom milled measuring surface provides maximum accuracy.
- High contrast vial system is easy to clean and optimises visibility.
- Amplified rare earth magnets for maximum holding power (only magnetic levels).
- Accurate to 0.029° (0.0005"/in, 0.5 mm/m) in standard position.
- Shock absorbing rubber end caps.



Description	Length (cm)	Handles	Pack quantity	Min. order quantity	Article Number	EAN Code
40 cm magnetic	40	0	1	1	4932459079	4002395281725
60 cm magnetic	60	0	1	1	4932459081	4002395281749
80 cm magnetic	80	0	1	1	4932459083	4002395281763
100 cm magnetic	100	0	1	1	4932459085	4002395281787
120 cm magnetic	120	0	1	1	4932459087	4002395282401
180 cm magnetic	180	0	1	1	4932459089	4002395282425
40 cm non-magnetic	40	0	1	1	4932459078	4002395281718
60 cm non-magnetic	60	0	1	1	4932459080	4002395281732
80 cm non-magnetic	80	0	1	1	4932459082	4002395281756
100 cm non-magnetic	100	0	1	1	4932459084	4002395281770
120 cm non-magnetic	120	0	1	1	4932459086	4002395281794
180 cm non-magnetic	180	0	1	1	4932459088	4002395282418
End-caps for REDSTICK [™] compact levels			2	1	4932459681	4058546028534

TiD-extra
Industrial Technologies d.o.o.

REDSTICK[™] concrete levels



- SHARPSITE[™] vial technology improves the readability of the vial.
- Ergonomic keyhole profile delivers maximum durability and continuous grip across entire level.
- Wide magnesium base for enhanced screeding functionality and cleanability.
- Dedicated working edges include a rounded and a squared bottom edge for cutting and finishing concrete.
- High contrast vial system is easy to clean and optimises visibility.
- Vial surrounds are optimised for screeding applications and cleanability.
- Slope vials rated for 1/8" & 1/4" (1% & 2%).



Description	Length (cm)	Handles	Pack quantity	Min. order quantity	Article Number	EAN Code
60 cm non-magnetic	60	0	1	1	4932459893	4058546030650
120 cm non-magnetic	120	0	1	1	4932459894	4058546030667
180 cm non-magnetic	180	0	1	1	4932459895	4058546030674

Slim box levels



- 2 solid acrylic vials. Shockproof and UV resistant.
- Precision milled measuring surface up to 120 cm provides maximum accuracy.
- Shock absorbing end caps.
- Durable hang hole for storage.
- VPA third party certificate on accuracy.
- Accurate to 0.029° (0.0005 ʹ/in, 0.5 mm/m) in standard position.



10 YEARS ACCURACY GUARANTEE
 JAHRE GENAUIGKEITSGARANTIE
 ANS DE PRECISION GARANTIE
 ① www.milwaukeetool.eu

Description	Length (cm)	Pack quantity	Min. order quantity	Article Number	EAN Code
40 cm magnetic	40	1	1	4932464854	4058546227999
60 cm magnetic	60	1	1	4932464855	4058546228002
100 cm magnetic	100	1	1	4932464856	4058546228019
180 cm magnetic	180	1	1	4932464857	4058546228026
20 cm non-magnetic	20	1	10	4932472091	4058546324872
40 cm non-magnetic	40	1	1	4932459090	4002395282432
60 cm non-magnetic	60	1	1	4932459091	4002395282449
80 cm non-magnetic	80	1	1	4932459092	4002395282456
100 cm non-magnetic	100	1	1	4932459093	4002395282463
120 cm non-magnetic	120	1	1	4932459094	4002395282470
180 cm non-magnetic	180	1	1	4932459095	4002395282487
200 cm non-magnetic	200	1	1	4932459590	4058546027629



TiD-extra
 Industrial Technologies d.o.o.

I-beam levels



- Lightweight reinforced aluminium frame.
- Magnetic edge allows hands free use when working with metal.
- Accurate to 0.029° (0.0005 ʹ/in, 0.5 mm/m) In normal and reverse position.
- Pitch Vial for easy reading of 1 and 2 degree pitch.
- High contrast vial surrounds for maximised visibility.
- Shock absorbing end caps.



NEW

10 YEARS ACCURACY GUARANTEE
 JAHRE GENAUIGKEITSGARANTIE
 ANS DE PRECISION GARANTIE
 ① www.milwaukeetool.eu

Description	Length (cm)	Handles	Pack quantity	Min. order quantity	Article Number	EAN Code
I-Beam Level Magnetic - 60 cm	60	1	1	1	4932478565	4058546347581
I-Beam Level Magnetic - 120 cm	120	2	1	1	4932478566	4058546347598
I-Beam Level Magnetic - 200 cm	200	2	1	1	4932478567	4058546347604

HAND TOOLS

REDCAST die-cast levels



- 2 solid acrylic vials. Shockproof and UV resistant.
- 2 Heavy Duty cast aluminium "anvil" strike pads for trowel blows during tile work.
- Drill bit diameter gauge in the level's profile from 5 to 12 mm.
- Precision milled measuring surface provides maximum accuracy.
- Durable hang hole for storage.
- VPA third party certificate on accuracy.
- Accurate to 0.029° (0.0005 1/16", 0.5 mm/m).



10 YEARS ACCURACY GUARANTEE
 JAHRE GENAUIGKEITSGARANTIE
 ANS DE PRÉCISION GARANTIE
 ⓘ www.milwaukeetool.eu

Description	Length (cm)	Pack quantity	Min. order quantity	Article Number	EAN Code
REDCAST die-cast level 60 cm	60	1	1	4932459098	4002395283118
REDCAST die-cast level 80 cm	80	1	1	4932459099	4002395283125

Block torpedo level



- SHARPSITE™ vial technology improves the readability of the vial.
- Locking 360° adjustable vial. Identify and repeat any angle needed on the jobsite. Lock vial in place to keep accuracy in and out of pocket/pouch.
- Amplified rare earth magnets for maximum holding power.
- Reinforced plumb vials. Solid, acrylic block vials offer maximum durability.
- Die cast aluminium body withstands the conditions of the jobsite.
- Precision milled measuring surface provides maximum accuracy.
- Lanyard hole for use with all most prevention programs.
- Accurate to 0.029° (0.0005 1/16", 0.5 mm/m).



30 YEARS ACCURACY GUARANTEE
 JAHRE GENAUIGKEITSGARANTIE
 ANS DE PRÉCISION GARANTIE
 ⓘ www.milwaukeetool.eu

Description	Length (cm)	Pack quantity	Min. order quantity	Article Number	EAN Code
Block torpedo level	25	1	1	4932459096	4002395282494

Billet torpedo level



- Amplified rare earth magnets for maximum holding power.
- Maximised viewing area. Easily read slope in 1/8" or 1/4" per foot in either direction.
- Reinforced acrylic vials offer maximum durability.
- Weld clearance. Easily level over weld joints in pipes and other materials.
- Optimised V-groove design for stability on non-ferrous pipes.
- Laser etched ruled edge for quick measurements on material.
- Slim, tapered design for easy sliding in and out of pockets and pouches.



10 YEARS ACCURACY GUARANTEE
 JAHRE GENAUIGKEITSGARANTIE
 ANS DE PRÉCISION GARANTIE
 ⓘ www.milwaukeetool.eu

Description	Length (cm)	Pack quantity	Min. order quantity	Article Number	EAN Code
Billet torpedo level	17	1	1	4932459097	4002395283101

Pocket level



- 360° adjustable vial for reading angles.
- Locking mechanism for repetitive use in and out of pocket/pouch.
- Amplified Rare-Earth magnets for maximum holding power.
- V-groove for leveling on pipes.
- Milled edge to ensure accuracy.
- Compact size for jobsite functionality.



Description	Length (cm)	Pack quantity	Min. order quantity	Article Number	EAN Code
Pocket level	7.8	1	6	4932459597	4058546027698

Compact torpedo



- SHARPSITE™ Pitch Vial for easy reading of 1 and 2 degree pitch.
- Sub compact design for working in tight spaces.
- Optimized V-groove design for stability of rounded surfaces.
- Weld clearance to level over weld lines in pipe and other material.
- Amplified rare earth magnets for maximum holding power.
- Accurate to 0.029° (0.0005 "/in, 0.5 mm/m).



Description	Length (cm)	Pack quantity	Min. order quantity	Article Number	EAN Code
Compact torpedo	7.6	1	1	4932472122	4058546325183

Minibox level



- Lightweight aluminium box profile fits easily into your tool belt or pocket.
- Solid acrylic vial. Shockproof and UV resistant vials.
- Shockproof end caps.
- Accurate to 0.029° (0.0005 "/in, 0.5 mm/m) in standard position.
- VPA third party certificate on accuracy.



Description	Length (cm)	Pack quantity	Min. order quantity	Article Number	EAN Code
Minibox level	10	1	10	4932459100	4002395283446

Chalk reel

- Extra bold lines - 2 mm thick line for maximum visibility.
- Planetary gear system for increased durability.
- 4/1 gear ratio for fast line retraction.
- Large chalk capacity.
- Easy refills due to the extra large quick turn opening.
- Easy line securing due to the line lock.



Description	Pack quantity	Min. order quantity	Article Number	EAN Code
① 30 m large capacity chalk reel	1	1	4932471634	4058546295332
② 45 m large capacity chalk reel	1	1	4932471635	4058546295349
③ 30 m replacement line chalk reel	1	1	4932471636	4058546295356
45 m replacement line chalk reel	1	1	4932471637	4058546295363

Framing Square

- Reinforced Frame.
- Laser etched markings provide superior visibility
- Precision scribe notches for easy marking.
- Common conversion table.
- Markings to assist in angle finding.



Description	Length (cm)	length (Inch)	Pack quantity	Min. order quantity	Article Number	EAN Code
Framing Square Metric	40cm x 60cm	-	1	1	4932472126	4058546325220
Framing Square Imperial	-	16" x 24"	1	1	4932472125	4058546325213

Rafter Square

- Precision Scribe Notches for easy marking.
- High Visibility Laser Etched Markings.
- Pipe Prop to assist in cutting pipe materials.
- Increased heel width for improved grip.



Description	Length (cm)	length (Inch)	Pack quantity	Min. order quantity	Article Number	EAN Code
Rafter Square Metric	18cm	-	1	1	4932472123	4058546325190
Rafter Square Imperial	-	7"	1	1	4932472124	4058546325206

INKZALL™ markers

- Stays sharp, doesn't mushroom or push back under pressure.
- Acrylic nib ideal for rough surfaces such as OSB and concrete.
- Marker continues to write after 72+ hours of cap off time.
- For use on concrete, wood, metal, plywood, OSB, plastic.
- Can be used on wet, oily, dusty, rusty, with debris surfaces.
- Quick dry time – reduced smearing markings on PVC, metal surfaces.
- Thin body for use in restricted areas.
- Helmet clip – can be clipped to the construction site cap, trousers, overalls.
- Easy open cap for one hand operation.
- Anti-Roll design - won't roll off surfaces.

Description	Colour	Tip	Pack quantity	Min. order quantity	Article Number	EAN Code
① INKZALL™ marker*	Black	1mm	1	36	48223100	045242319473
② INKZALL™ marker*	Red	1mm	1	36	48223170	045242355259
③ INKZALL™ marker with stylus	Black	1 mm	1	1	48223101	045242297436
④ INKZALL™ fine tip markers	Black	0.6 mm	4	1	48223154	045242479764
⑤ INKZALL™ colour markers Blue, red, green and black		1mm	4	1	48223106	045242333585
⑥ INKZALL™ chisel point marker	Black	1- 4,8 mm	1	1	48223103	045242333608

* Orders are only possible in master cartons (contains 36 x 48223100). Minum order quantity is 36 pcs (= 1 master carton). Order quantities greater than 36 pcs are to be ordered in multiples of 36 pcs (i.e. 72, 108, 144, 180...).



TiD-extra
 Industrial Technologies d.o.o.

INKZALL™ chisel tip markers

- Marker continues to write after 72+ hours of cap off time.
- Can be used on wet, oily, dusty, rusty, with debris surfaces.
- For use on concrete, wood, metal, plywood, OSB, plastic.
- Quick dry time – reduced smearing markings on PVC, metal surfaces.
- Easier to read from a distance due to the increased chisel tip sizes.

Description	Colour	Tip	Pack quantity	Min. order quantity	Article Number	EAN Code
① INKZALL™ black chisel tip marker L (3pc)	Black	6,2mm	3	1	4932471554	4058546294533
② INKZALL™ black chisel tip marker L	Black	6,2mm	1	12	4932471555	4058546294540
③ INKZALL™ red chisel tip marker L	Red	6,2mm	1	12	4932471556	4058546294557
④ INKZALL™ blue chisel tip marker L	Blue	6,2mm	1	12	4932471557	4058546294564
⑤ INKZALL™ black chisel tip marker XL (1 pack)	Black	14,5mm	1	1	4932471558	4058546294571
⑥ INKZALL™ black chisel tip marker XL	Black	14,5mm	1	12	4932471559	4058546294588
⑦ INKZALL™ red chisel tip marker XL	Red	14,5mm	1	12	4932471560	4058546294595
⑧ INKZALL™ blue chisel tip marker XL	Blue	14,5mm	1	12	4932471561	4058546294601



HAND TOOLS

INKZALL[™] liquid paint markers

- Valve action marker.
- Durable acrylic nib for the most demanding environmental conditions: surface temperature from -10° up to + 145°.
- Marks on dark surfaces where traditional markers would not be easily visible.
- Can be used on rough, dirty and greasy surfaces.
- For use on concrete, black pipe, aluminium, PVC, steel & stainless steel, rubber and tyres.
- 10 seconds dry time.
- Water and UV resistant markings.
- Permanent markers. Markings last up to 6 months.
- Metal barrel for construction site durability.
- Xylene-free paint.
- **IMPORTANT:** Shake the marker with the cap on. Remove the cap and carefully pump it up and down until ink flows into the nib.



Description	Pack quantity	Min. order quantity	Article Number	EAN Code
① INKZALL [™] liquid paint marker - white	1	12	48223711	045242363360
② INKZALL [™] liquid paint marker - yellow	1	12	48223721	045242363377
③ INKZALL [™] liquid paint marker - black	1	12	48223731	045242363384

INKZALL[™] highlighters

- Durable tip stays sharp longer.
- No smearing, doesn't bleed through.
- Non-toxic ink, ASTM D 4236 certification.
- Ideal for architectural drawings, labels, office paper.
- Anti-roll body design for better grip on smooth surfaces.
- Construction helmet clip: the INKZALL[™] highlighters can be clipped to the helmet, trousers, overalls, etc.
- Lanyard hole, e.g. to attach the INKZALL[™] highlighters to the belt.

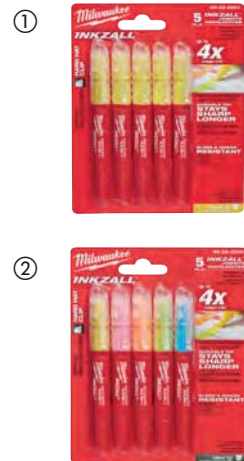

Description	Pack quantity	Min. order quantity	Article Number	EAN Code
① INKZALL [™] highlighter - yellow	5	1	48223201	045242482573
② INKZALL [™] highlighter - coloured	5	1	48223206	045242482580

INKZALL[™] fine tip pens

- Approx. 0.6 mm tip.
- Clog resistant.
- Main applications: marking of labels for electrical wires, adding comments to architect plans.

Description	Colour	Pack quantity	Min. order quantity	Article Number	EAN Code
① INKZALL [™] fine tip pens (4pc) - black	Black	4	1	48223164	045242479818
② INKZALL [™] fine tip pens (4pc) - coloured	Black, red and blue	4	1	48223165	045242479825



FASTBACK™ flip utility knife

- One handed blade opening. User can flip open the blade with one hand for easy activation.
- Integrated gut hook. Allows users to make cuts without exposing the blade.
- Tool free blade change. Less down time in the field for blade changes.
- Wire stripper. Eliminates the need to look for another tool in user's bag.
- Thin body design. Tool is easily stored in user's pocket.
- Belt clip for easy storage.



Description	Pack quantity	Min. order quantity	Article Number	EAN Code
① FASTBACK™ compact flip utility knife	1	1	4932471356	4058546289843
② FASTBACK™ flip utility knife	1	6	4932471357	4058546289850
③ FASTBACK™ flip utility knife with blade storage	1	1	4932471358	4058546289867

FASTBACK™ 6 in 1 utility knife

NEW

- 1/4" Hex bit holder with double ended PH2 and SL5.5
- One handed blade opening. User can flip open the blade with one hand for easy activation.
- Tool free blade change. Less down time in the field for blade changes.
- Wire stripper. Eliminates the need to look for another tool in user's bag.
- Belt clip for easy storage.
- Integrated bottle opener.

Description	Pack quantity	Min. order quantity	Article Number	EAN Code
6 in 1 utility knife	1	1	4932478559	4058546347529



FASTBACK™ folding knife

- Press and flip operation permits one-handed opening.
- Resharpenable stainless steel blade.
- Piercing tip allows controlled piercing and smooth cutting.
- Liner lock secures the blade in the open position.
- Lanyard hole.
- Wire form belt clip for quick access without fraying pockets.

Description	Pack quantity	Min. order quantity	Article Number	EAN Code
FASTBACK™ folding knife	1	1	48221990	045242296842



Compact pocket knife

NEW

- Compact size for carrying in the pocket.
- Resharpenable stainless steel blade.
- Piercing tip allows controlled piercing and smooth cutting.
- Liner lock secures the blade in the open position.
- Lanyard hole.

Description	Pack quantity	Min. order quantity	Article Number	EAN Code
Compact pocket knife	1	1	4932478560	4058546347536



Fixed blade knife

- The fixed blade knife is designed for optimal edge retention and durability
- 4" (101mm) stainless steel blade, optimised to stay sharper longer
- Full metal tang provides durability for tough cut
- Ergonomic handle offers secure and comfortable grip
- Lanyard hole for easy tethering
- Durable moulded sheath with belt clip for fast access



Description	Pack quantity	Min. order quantity	Article Number	EAN Code
Fixed blade knife	1	1	4932464828	4058546227739

Hawkbill fixed blade knife

- The hawkbill fixed blade knife is ideal for stripping wire and cable.
- Stainless steel blade is optimised to stay sharper longer.
- Full metal tang provides durability for tough cuts.
- Large ergonomic handle designed for comfortable use with gloves.
- Lanyard hole for easy tethering.
- Durable molded sheath with belt clip for fast access.



Description	Pack quantity	Min. order quantity	Article Number	EAN Code
Hawkbill fixed blade knife	1	1	4932464829	4058546227746

HARDLINE[™] folding knives

- Premium D2 blade steel provides better corrosion resistance. High strength and wear resistance, stays sharp longer.
- Smooth / serrated 75mm blade and piercing tip. Ideal for tearing through material and tip allows controlled piercing.
- Flip opening with bearing system: can be opened with 2 hands only.
- Opening steel frame lock secures the blade in the open position.
- Glass filled nylon handle with stainless steel.
- Liner lock secures the blade in the open position.
- Lanyard hole.
- Reversible belt clip allows right or left handed carry.



Description	Blade type	Pack quantity	Min. order quantity	Article Number	EAN Code
① HARDLINE [™] folding knife - smooth	Smooth	1	1	48221994	045242477043
② HARDLINE [™] folding knife - serrated	Serrated	1	1	48221998	045242359165

HARDLINE[™] fixed blade knife

- 5" (127mm) AUS-8 Steel blade allows the blade to hold its edge longer, reducing the user's need to sharpen.
- Full metal tang provides durability for tough cuts.
- Overmolded handle for a strong secure grip, and a lanyard hole.
- Durable multi position sheath for flexible carry option and fast access.



Description	Pack quantity	Min. order quantity	Article Number	EAN Code
HARDLINE [™] fixed blade knife	1	1	4932464830	4058546227753

Fixed blade utility knife

- Ready to use fixed blade for an easier and fastest access to the knife.
- Tool-free blade change: Saves time changing blades. Thumb-screw mechanism allows to change the blade quickly and without any extra tools.
- Blade storage holds up to 5 blades conveniently inside the handle.
- Tool lanyard hole for easy tethering.
- Heavy Duty: Durable full metal body.



Description	Pack quantity	Min. order quantity	Article Number	EAN Code
Fixed blade utility knife	1	1	4932471361	4058546289898

Sliding utility knife

- Side blade activation: Reduces the risk of exposing the blade accidentally.
- Wire stripper: Eliminates the need for another tool in the users bag.
- Tool free blade change: Saves time changing blades.
- Blade storage: Magnetic holder for 5 blades.
- Heavy Duty: Full metal body with rubber overmould for increased comfort and reduced hand slippage.



Description	Pack quantity	Min. order quantity	Article Number	EAN Code
① Sliding utility knife	1	6	4932471359	4058546289874
② Compact slide utility knife	1	1	4932478561	4058546347543

Self-retracting safety knife

- Self-retract mechanism: Retracts blade when the button is released.
- Two blade positions allows user to control cutting depth.
- Blade storage holds up to 5 blades conveniently inside the handle.
- Tool-free blade change: Saves time changing blades. Thumb-screw mechanism allows to change the blade quickly and without any extra tools.
- Heavy Duty: Durable full metal body.
- Wire Stripper: Eliminates the need to look for another tool in users' bag. Cut up the wire up to Ø 5 mm².



Description	Pack quantity	Min. order quantity	Article Number	EAN Code
Self-retracting safety knife	1	1	4932471360	4058546289881

General purpose utility blades

- Iron carbide deposited metal for longer lifetime.
- Optimised cutting angle geometry for sharpness.
- Extra ground cutting edge for cleaner cuts.
- Blades are protected and easily accessible from storage box.

Description	Total length (mm)	Height (mm)	Pack quantity	Min. order quantity	Article Number	EAN Code
① General purpose utility knife blades	62	19	50	1	48221950	045242344444
			5	1	48221905	045242268061
② Hook utility knife blades	62	19	50	1	48221952	045242286980
③ Carton utility knife blades (rounded).	62	19	5	1	48221934	045242286942



Snap knives

- Metal lock* for maximum durability and longer lifetime.
- Lock with a speed thread* that allows faster blade adjustment.
- Auto-lock slide** for faster blade adjustment.
- Snap-off cap pocket clip** snaps off blade segments.
- Overmolded handle offers a slip resistant grip and is an acetone resistant.
- Iron carbide blade for longer lifetime, increased sharpness and clean cut finish.

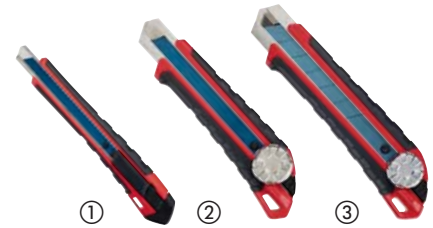

Description	Blade width (mm)	No. blade points	Pack quantity	Min. order quantity	Article Number	EAN Code
① Snap knife 9 mm	9	13	1	1	48221960	045242296811
② Snap knife 18 mm	18	8	1	1	48221961	045242296798
③ Snap knife 25 mm	25	7	1	1	48221962	045242296828

Snap blades

- Robust re-usable storage dispenser with easy access to blades.
- Optimized cutting angle geometry for sharpness and improved cutting precision.
- Iron carbide metal for longer life.
- Precise ground cutting edges for cleaner cuts.

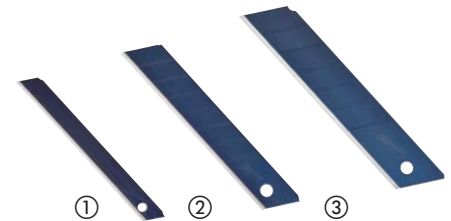

Description	Blade width (mm)	No. blade points	Pack quantity	Min. order quantity	Article Number	EAN Code
① Snap blades 9 mm	9	13	10	1	48229109	045242288649
② Snap blades 18 mm	18	8	10	1	48229118	045242288656
③ Snap blades 25 mm	25	7	10	1	48229125	045242288663

PVC saw

- All-metal handle design for best-in-class durability.
- Tool free blade change: up to 10x faster blade change.
- Overmold handle for increased comfort.
- Compact design.



Description	Pack quantity	Min. order quantity	Article Number	EAN Code
PVC saw	1	1	48220212	045242467518
PVC saw replacement blade	1	1	48220222	045242467532

Compact hacksaw

- Tool free blade change for changing blades up to 10x faster.
- Compact design, ideal for versatile cutting in tight spaces.
- Adjustable blade length for easier flush cutting.
- Rubber overmould grip for increased comfort.
- Accepts 12" blades.
- Supplied with 10" / 24 Tpi blade.



Description	Pack quantity	Min. order quantity	Article Number	EAN Code
Compact hacksaw	1	1	48220012	045242204571

Folding job saw

- Tool free blade change: Change blades up to 10x faster.
- Folding blade: Easier and safer storage.
- Rubber overmould grip: Increased comfort.
- Accepts all SAWZALL™ blades for increased versatility.
- Supplied with 18 TPI, 150 mm blade.



Description	Blade length (mm)	Pack quantity	Min. order quantity	Article Number	EAN Code
Folding job saw	150	1	1	48220305	045242204618

Hacksaw

- Tough metal frame, supports higher tension (25,000 PSI / 250 lbs).
- Overmould handle ensures secure grip and user comfort.
- Internal blade storage for extra blades.
- Supplied with 12" / 24 Tpi blade.



Description	Pack quantity	Min. order quantity	Article Number	EAN Code
Hacksaw	1	1	48220050	045242362226

Rasping jab saw

- 150 mm plaster / drywall blade: Extra strong thicker blade making it more resistant for plunge cuts.
- Coated for corrosion protection.
- Rubber overmould: Increased comfort and reduced hand slippage.
- Built in rasping holes: Allows user to rapidly expand holes or smooth rough edges.



Description	Pack quantity	Min. order quantity	Article Number	EAN Code
Rasping jab saw	1	6	48229304	045242480555

Jobsite scissors

- Iron carbide cutting edge for maximum durability. Longer lifetime vs. stainless steel.
- Chrome plated blades for maximum rust protection.
- All metal core: Full metal handle construction to protect from drops and handle breakage.
- Bolt lock technology protects blades from loosening to ensure precise cutting.
- Large handle loops for use with gloves.
- Index finger groove for more comfort.
- Laser edged ruler markings on the blade allows to measure and cut in one go.
- Jobsite offset scissors with micro-serrated blades for maximum durability and better grip.
- Jobsite offset scissors with 60°-offset head allows to keep hand above cutting material.



Description	Total length (mm)	Blade length (mm)	Weight (g)	Pack quantity	Min. order quantity	Article Number	EAN Code
① Straight scissors	230	95	180	1	1	48224044	045242347483
② Offset scissors	240	115	230	1	1	48224043	045242347476

Metal Aviation Snips

- Thumb and forefinger slots for increased comfort and less fatigue. Allows user to push through sheet metal with ease with less risk of cutting oneself.
- Serrated cutting edges prevent slippage when cutting.
- Less hand fatigue when cutting thicker materials. Design with compound leverage action.
- Torsion spring opens jaws automatically during cutting for faster cutting action and less fatigue work.
- Chrome plated rust protected forged blades for increased lifetime. Extra hardened to 65 HRC.
- Made from forged alloy steel for best durability – Cr Steel.
- One hand locking mechanism.
- Flush slimline design for non-snagging in material.
- Triple cutting direction identification – on the head, handle and by colour coded handle.
- Ergonomic and durable overmoulded grips add comfort and last longer.
- Aviation snips: For short, straight and shaped cuts. Ideal for narrow radius cuts and notch cuts.
- Offset snips: For long continuous straight or curved cuts. 45° offset keeps users hand away from the cutting material.
- Extra long aviation snips: For longer and straighter cuts in one go.

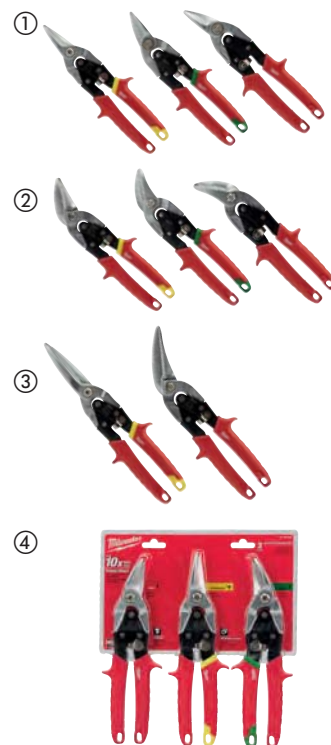

Cutting direction	Total length (mm)	Edge length (mm)	Max. cutting capacity aluminium (mm)	Max. cutting capacity stainless steel (mm)	Weight (g)	Pack quantity	Min. order quantity	Article Number	EAN Code
① Aviation snips: For short, straight and shaped cuts. Ideal for narrow radius cuts and notch cuts.									
Straight (yellow)	260	31	1.0	0.6	430	1	1	48224530	045242503643
Right (green)	260	31	1.0	0.6	430	1	1	48224520	045242503636
Left (red)	260	31	1.0	0.6	430	1	1	48224510	045242503629
② Offset snips: For long continuous straight or curved cuts. 45° offset keeps users hand away from the cutting material.									
Straight (yellow)	260	37	1.0	0.6	430	1	1	48224532	045242503674
Right (green)	260	30	1.0	0.6	430	1	1	48224522	045242503667
Left (red)	260	30	1.0	0.6	430	1	1	48224512	045242503650
③ Extra long aviation snips: For longer and straighter cuts in one go.									
Straight (yellow)	310	76	1.0	0.6	450	1	1	48224537	045242503681
Left (offset)	290	63	1.0	0.6	450	1	1	48224538	045242503698
④ Metal snips set (3pc) 48224510, 48224530 and 48224520									
						3	1	48224533	045242503735

Mini copper tubing cutters

- Proprietary adjustment mechanism.
- Chrome rollers for added durability and extended performance provide best in class rust protection.
- Easy grip knob allows faster adjustment and easier one handed use.
- Compact design to cut pipes in restricted areas.



Description	Max. cutting capacity in copper pipe (mm)	Pack quantity	Min. order quantity	Article Number	EAN Code
Mini copper tubing cutter 15 mm	3 - 15	1	1	48229250	045242521210
Mini copper tubing cutter 22 mm	3 - 22	1	1	48229258	045242521258
Mini copper tubing cutter 28 mm	3 - 28	1	1	48229251	045242521227



Constant swing copper tubing cutters

- Constant swing copper tubing cutters are engineered for straighter, cleaner cuts.
- 4 roller design delivers accurate cuts and prevents walking.
- Chrome rollers for added durability and extended performance provide best in class rust protection.
- Smooth adjustment mechanism.
- On-board reamer enables fast, easy deburring.
- A spare wheel is integrated in the knob.



Description	Max. cutting capacity in copper pipe (mm)	Pack quantity	Min. order quantity	Article Number	EAN Code
Constant swing copper tubing cutter 28 mm	3 - 28	1	1	48229259	045242521265
Constant swing copper tubing cutter 42 mm	3 - 42	1	1	48229252	045242521234
Constant swing copper tubing cutter 67 mm	16 - 67	1	1	48229253	045242521241
Reaming blades		3	1	48224257	045242356263



Tubing cutter blades

- Replacement blades for tubing cutters.

Description	Pack quantity	Min. order quantity	Article Number	EAN Code
Tubing cutter blades for copper	2	1	48224256	045242356256
Tubing cutter blades for stainless steel	4	1	4932464511	4058546224561



Reaming pen

- Provides easy deburring of copper tubing and PVC.
- All-metal design for durability through demanding jobsite use.
- Heat treated and black oxide coated blade for extended life.
- A slide resistant clip allows easy storage in the users pocket or tool bag for quick access.



Description	Pack quantity	Min. order quantity	Article Number	EAN Code
① Reaming pen	1	1	48224255	045242356249
Reaming blades	3	1	48224257	045242356263

Plastic cutter

- Cuts PEX, PB, MDP, PE, plastic electrical conduits, pneumatic pipe, plastic overflow pipe, rubber hoses, silicon hoses up to Ø 25 mm.
- V-shaped blade allows quick and straight cuts; prevents crushing of material.
- Replaceable stainless steel blade.
- Robust construction: Metal core from the head to the handles for maximum lifetime.
- Grooves on the head allows stripping of couplings.
- Corrosion resistant head.
- One handed locking mechanism, tool remains closed while in pouch, spring loaded but easy opening.
- Ergonomic and durable overmoulded grips add comfort and last longer.



Description	Max. capacity tube & pipe Ø (mm)	Pack quantity	Min. order quantity	Article Number	EAN Code
Plastic cutter	25	1	1	48224202	045242343133
Replaceable blade		1	1	48224203	045242343140



Ratcheting PVC cutter

- Durable stainless steel rust proof blade for more cuts.
- Comfortable handle adds working comfort.
- Quick blade release adds working speed.
- One-handed metal lock.
- Lanyard hole, improves working security.
- Blades are replaceable.
- Suitable for: PVC, CPVC, PEX, PP, PB, PVDF, PE.



Description	Max. capacity tube & pipe Ø (mm)	Pack quantity	Min. order quantity	Article Number	EAN Code
① Ratcheting PVC cutter 42 mm	42	1	1	4932464172	4058546221171
① Ratcheting PVC cutter 63 mm	63	1	1	4932464173	4058546221188
② Ratcheting PVC cutter blade 42 mm		1	1	48224211	045242477012
② Ratcheting PVC cutter blade 63 mm		1	1	48224216	045242477036



Cable cutter

- Best-in-class cut quality: Bevelled jaw heads for accurate, smooth cable shearing.
- Comfort grips: More comfortable than dipped plastic. Grips will not peel.
- Forged design: Tool durability in abusive environments.
- Rust protection: Black oxide finish protects from rust.



Description	Pack quantity	Min. order quantity	Article Number	EAN Code
Cable cutter	1	1	48226104	045242356140



Bolt cutters

- Forged steel blades for strong and durable cutting edge.
- Comfort grip handles will not peel or slide off.
- Blade adjustment screw ensures high performance and longer life.
- Lanyard holes.



Description]	Blade width (mm)	Cutting capacity for HRC 31 materials (Max. Ø mm)	Cutting capacity for HRC 48 materials (Max. Ø mm)]	Pack quantity	Min. order quantity	Article Number	EAN Code
14" bolt cutter	13	8	5	1	1	4932464827	4058546227722
24" bolt cutter	13	11	8	1	1	4932464826	4058546227715



Extendable bolt cutters

- POWERMOVE[™] handles extend for easier cuts in tough applications.
- Forged steel blades for strong and durable cutting edge.
- Pivoting head for angle adjustment.
- Comfort grip handles will not peel or slide off.
- Lanyard holes.



Description	Blade width (mm)	Cutting capacity for HRC 31 materials (Max. Ø mm)	Cutting capacity for HRC 48 materials (Max. Ø mm)]	Pack quantity	Min. order quantity	Article Number	EAN Code
14" / 18" extendable bolt cutter	13	8	5	1	1	4932464850	4058546227951
24" / 30" extendable bolt cutter	13	11	8	1	1	4932464851	4058546227968



Nail Puller

NEW

- Dimpler allows for easy nail removal with limited damage to surface.
- Low profile claw to reach the tightest of nails.
- Handle grip greatly reduces vibration.



Description	Length (cm)	Pack quantity	Min. order quantity	Article Number	EAN Code
9" Nail Puller	22.86cm	1	1	4932478249	4058546344269
10" Nail Puller	25.40cm	1	1	4932478250	4058546344276
12" Nail Puller	30.48cm	1	1	4932478251	4058546344283



Trim Puller

NEW

- Low profile trim claw to easily slide between trim/skirting boards and walls.
- Dimpler allows for easy nail removal with limited damage to surface.
- Handle grip greatly reduces vibration.



Description	Length (cm)	Pack quantity	Min. order quantity	Article Number	EAN Code
10" Trim Puller	25.40cm	1	1	4932478252	4058546344290



Wrecking Bar

NEW

- Beveled edge improves leverage and accessibility when pulling nails, lifting or prying.
- Nail/staple puller easily removes nails and staples without damaging flooring or surrounding materials.
- Reinforced strikable tongue for extra material penetration using a hammer.



Description	Length (cm)	Pack quantity	Min. order quantity	Article Number	EAN Code
12" Wrecking Bar	30.48cm	1	1	4932478253	4058546344306
15" Wrecking Bar	38.1cm	1	1	4932478254	4058546344313

Club hammer

NEW

- **Duel Face Versatility:** Milled face provides additional grip and minimizes movement of face when striking chisels or large nails, the smooth face prevents damage to struck objects.
- **Reinforced Overstrike Protection:** Increases durability in the most common failure point
- **Fiberglass handle with over molded grip:** Provides durability with improved grip capacity and comfort
- **Lanyard Hole:** Easily comply with safety regulations working at height



Description	Pack quantity	Min. order quantity	Article Number	EAN Code
1.36kg / 3lbs Club Hammer	1	1	4932478255	4058546344320

Curved hammer

- Precise balance for better handling.
- Durable grip construction.
- I-Beam handle construction resists bending in prying applications.
- Curved claw hammer reduces damage when pulling nails.
- Magnetic nail starter for safer application.







Description	Pack quantity	Min. order quantity	Article Number	EAN Code
20 oz / 14" curved claw hammer	1	1	4932464028	4058546219734

Tri-lobe screwdrivers

- Comfortable Tri-Lobe handle optimized for maximum user comfort and high torque applications.
- Permanent visible ID markings allows for quick tool identification.
- Landyard hole for easy attachment to a safety system.
- Hardened magnetic tips for maximum durability and fastener retention.



	Description	Shank type	Pack quantity	Min. order quantity	Article Number	EAN Code
	SL 0.4 x 2 x 65	Round	1	1	4932471773	4058546296728
	SL 0.4 x 2.5 x 75	Round	1	1	4932471774	4058546296735
	SL 0.5 x 3 x 75	Round	1	1	4932471775	4058546296742
	SL 0.5 x 3 x 150	Round	1	1	4932471776	4058546296759
	SL 0.6 x 3.5 x 100	Round	1	1	4932471777	4058546296766
	SL 0.8 x 4 x 100	Round	1	1	4932471778	4058546296773
	SL 1.0 x 5.5 x 125	Round	1	1	4932471779	4058546296780
	SL 1.2 x 6.5 x 45	Wrench ready	1	1	4932471780	4058546296797
	SL 1.2 x 6.5 x 125	Wrench ready	1	1	4932471781	4058546296803
	SL 1.2 x 8 x 150	Wrench ready	1	1	4932471782	4058546296810
SL 1.6 x 8 x 175	Wrench ready	1	1	4932471783	4058546296827	
SL 1.2 x 10 x 200	Wrench ready	1	1	4932471784	4058546296834	
	PH0 x 75	Wrench ready	1	1	4932471785	4058546296841
	PH1 x 100	Wrench ready	1	1	4932471786	4058546296858
	PH2 x 45	Wrench ready	1	1	4932471787	4058546296865
	PH2 x 125	Wrench ready	1	1	4932471788	4058546296872
	PH3 x 150	Wrench ready	1	1	4932471789	4058546296889
	PZ0 x 75	Wrench ready	1	1	4932471790	4058546296896
	PZ1 x 100	Wrench ready	1	1	4932471791	4058546296902
	PZ2 x 45	Wrench ready	1	1	4932471792	4058546296919
	PZ2 x 125	Wrench ready	1	1	4932471793	4058546296926
	PZ3 x 150	Wrench ready	1	1	4932471794	4058546296933
	T6 x 65	Round	1	1	4932471795	4058546296940
	T7 x 65	Round	1	1	4932471796	4058546296957
	T8 x 65	Round	1	1	4932471797	4058546296964
	T9 x 75	Round	1	1	4932471798	4058546296971
	T10 x 75	Round	1	1	4932471799	4058546296988
	T15 x 75	Round	1	1	4932471800	4058546296995
	T20 x 100	Round	1	1	4932471801	4058546297008
	T25 x 100	Round	1	1	4932471802	4058546297015
	T30 x 125	Round	1	1	4932471803	4058546297022
	T40 x 125	Round	1	1	4932471804	4058546297039



Description	Pack quantity	Min. order quantity	Article Number	EAN Code
① Tri-lobe screwdriver set 1 (6pc) PZ1 / PZ2 / SL3 / SL4 / SL5.5 / SL6.5	6	1	4932471806	4058546297053
② Tri-lobe screwdriver set 2 (6pc) PH1 / PH2 / SL3 / SL4 / SL5.5 / SL6.5	6	1	4932471807	4058546297060
Tri-lobe screwdriver set 3 (10pc) ③ PZ1 / PZ2 / PH1 / PH2 / SL3 / SL5.5 / SL6.5 / SL6.5 / SL8	10	1	4932471808	4058546297077
Tri-lobe screwdriver set 4 (12pc) ④ PZ0 / PZ1 / PZ2 / PH0 / PH1 / PH2 / SL2.5 / SL4 / SL5.5 / SL6.5 / SL6.5 / SL8	12	1	4932472003	4058546323998
Tri-lobe screwdriver Torx set (6pc) ⑤ T10 / T15 / T20 / T25 / T30 / T40	6	1	4932471809	4058546297084
Tri-lobe screwdriver stubby set (2pc) ⑥ PZ2 x 45mm / SL6.5 x 45mm	2	1	4932471810	4058546297091

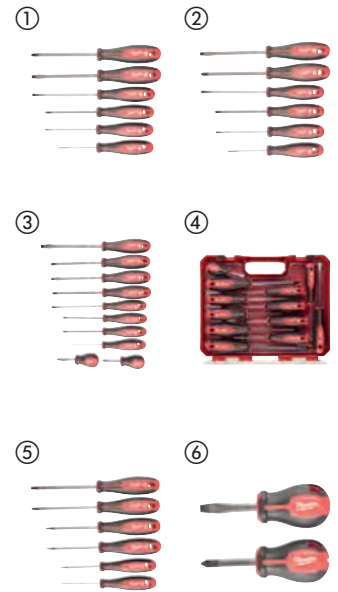

Tri-lobe demolition screwdriver

- Hammer ready strike caps
- All metal core
- Wrench ready shank
- Comfortable Tri-Lobe handle.

Description	Pack quantity	Min. order quantity	Article Number	EAN Code
Tri-lobe demolition screwdriver set PH2 / SL7.9 mm	2	1	4932471872	4058546297718



Demolition driver

- Hardened all metal core giving maximum shank durability.
- Multiple striking caps to give user more force when prying and chiseling.
- Duct piercing tip allows to pierce through sheet metal.

Description	Pack quantity	Min. order quantity	Article Number	EAN Code
Demo driver	1	1	4932471871	4058546297701



Precision screwdrivers

- All metal core for improved durability.
- 360° Rotating back cap.
- Chrome plated shanks increase tool life by reducing corrosion.
- Durable case with robust zipper included to store tools.
- Longer shanks for improved visibility and extended reach.

Description	Pack quantity	Min. order quantity	Article Number	EAN Code
Precision screwdriver set (6pc) PH00 / PH0, SL1.6 / SL2 / SL3.2 / SL4	6	1	4932471869	4058546297688
Torx precision screwdriver (6pc) T6, T7, T8, T9, T10, T15	6	1	4932471870	4058546297695



8 in 1 compact ratcheting multi-bit screwdriver

- Full metal high torque ratchet for 2 x driving speed and control.
- Chrome plated marine grade rust protected bits.
- Revolver style bit storage in handle.
- Precision hardened bit tips: Durable driving tips for secure fitment and long life.



Description	Pack quantity	Min. order quantity	Article Number	EAN Code
8 in 1 compact ratcheting multi-bit screwdriver PH1 / PH2 / PZ1 / PZ2 / TX15 / SL4.8 / SL6.4	1	1	4932471868	4058546297671



9 in 1 ratcheting multi-bit screwdriver

- Ergonomic 152 mm long screwdriver with 1/4" Hex nut driver (in reception) and built in loop maker.
- Full metal high torque ratchet for 2 x driving speed and control.
- 88 mm long power groove bits, power tool compatibility.
- Precision hardened bit tips: Durable driving tips for secure fitment and long life.
- Revolver style bit storage in handle.
- Chrome plated marine grade rust protected bits.





Description	Pack quantity	Min. order quantity	Article Number	EAN Code
9 in 1 ratchet multi-bit screwdriver - universal PH1 / PH2 / PZ1 / PZ2 / TX15 / TX20 / Slotted 0.8 x 5.5 mm	1	12	4932471598	4058546294977
9 in 1 ratchet multi-bit screwdriver - hex Hex 1.5 mm / Hex 2 mm / Hex 2.5 mm / Hex 3 mm / Hex 4 mm / Hex 5 mm / Hex 6 mm	1	12	4932471599	4058546294984

VDE Slim Screwdrivers

- VDE tested to 10, 000 V and guaranteed to 1,000 V.
- Premium quality steel with molybdenum and vanadium for flexibility and lifetime.
- CNC milled tips for high precision for best fit and reduced cammout effect.
- Black phosphate on the tip for grip and corrosion resistance.
- Slim shank diameter for access to low lying screw applications.
- 2 component grip with softgrip for comfortable handling.
- 3 sided design for non slip and maximum power transfer.
- Slim design at handle for low power/torque applications and fine electrical work.
- Laser engraved with the reception on the top of handle for easy identification.
- Anti roll, 3 sided collar on handle.



Type	Description	Pack quantity	Min. order quantity	Article Number	EAN Code
	SL 0.5 x 3 x 100	1	1	4932471445	4058546290733
	SL 0.8 x 4 x 100	1	1	4932471446	4058546290740
	SL 1.0 x 5.5 x 125	1	1	4932471447	4058546290757
	PH1 x 80	1	1	4932471448	4058546290764
	PH2 x 100	1	1	4932471449	4058546290771
	PZ1 x 80	1	1	4932471450	4058546290788
	PZ2 x 100	1	1	4932471451	4058546290795
①	VDE slim screwdriver set (5pc) SL3 / SL4 / SL5.5 / PZ1 / PZ2	1	1	4932471452	4058546290801
②	VDE slim screwdriver set (7pc) SL3 / SL4 / SL 5.5 / PH1 / PH2 / PZ1 / PZ2	1	1	4932471453	4058546290818

①













②



VDE screwdrivers

- VDE tested to 10, 000 V and guaranteed to 1,000 V.
- Premium quality steel with molybdenum and vanadium for flexibility and lifetime.
- CNC milled tips for high precision for best fit and reduced cammout effect.
- Black phosphate on the tip for grip and corrosion resistance.
- 2 component grip with softgrip for comfortable handling.
- 3 sided design for non slip and maximum power transfer.
- Slim design at front for low power/torque applications and fine electrical work.
- Laser engraved with the reception on the top of handle for easy identification.
- Anti roll, 3 sided collar on handle.



	Description	Pack quantity	Min. order quantity	Article Number	EAN Code
	SL 0.4 x 2.5 x 75	1	1	4932464034	4058546219796
	SL 0.5 x 3 x 100	1	1	4932464035	4058546219802
	SL 0.6 x 3.5 x 100	1	1	4932464036	4058546219819
	SL 0.8 x 4 x 100	1	1	4932464037	4058546219826
	SL 1.0 x 5.5 x 125	1	1	4932464038	4058546219833
	SL 1.2 x 6.5 x 150	1	1	4932464039	4058546219840
	SL 1.2 x 8 x 175	1	1	4932464040	4058546219857
	SL 0.5 x 3 x 65	1	1	4932464041	4058546219864
	PH0 x 60	1	1	4932464042	4058546219871
	PH1 x 80	1	1	4932464043	4058546219888
	PH2 x 100	1	1	4932464044	4058546219895
	PH3 x 150	1	1	4932464045	4058546219901
	PZ0 x 60	1	1	4932464046	4058546219918
	PZ1 x 80	1	1	4932464047	4058546219925
	PZ2 x 100	1	1	4932464048	4058546219932
	PZ3 x 150	1	1	4932464049	4058546219949
	T10 x 60	1	1	4932464050	4058546219956
	T15 x 75	1	1	4932464051	4058546219963
	T20 x 100	1	1	4932464052	4058546219970
	T25 x 100	1	1	4932464053	4058546219987
	T30 x 100	1	1	4932464054	4058546219994
	PH/SL1 x 80	1	1	4932464055	4058546220006
	PH/SL2 x 100	1	1	4932464056	4058546220013
	PZ/SL1 x 80	1	1	4932464057	4058546220020
	PZ2/SL2 x 100	1	1	4932464058	4058546220037
	Socket wrench SW6 x 125	1	1	4932464059	4058546220044
	SW7 x 125	1	1	4932464060	4058546220051
	SW8 x 125	1	1	4932464061	4058546220068
	SW9 x 125	1	1	4932464062	4058546220075
	SW10 x 125	1	1	4932464063	4058546220082
	SW11 x 125	1	1	4932464064	4058546220099
	SW13 x 125	1	1	4932464065	4058546220105
	VDE screwdriver set (5pc) SL3 / SL4, PZ1 / PZ2 and voltage tester	5	1	4932464066	4058546220112
	VDE Screwdriver set 1 (7pc) SL2.5 / SL3 / SL4, PH2, PZ1 / PZ2 and voltage tester	7	1	4932464067	4058546220129
	VDE Screwdriver set 2 (7pc) SL2.5 / SL3 / SL4 / SL5.5, PH1 / PH2 and voltage tester	7	1	4932464068	4058546220136



VDE pliers

- VDE (DIN EN/IEC 60900) certified tools. Tested to 10,000 volts and guaranteed to 1,000 volts. Tested against cold to -40°.
- Steel blades are fully forged, hardened and tempered for best durability. Grey titanium surface finish is non reflective and ensures maximum corrosion resistance.
- Induction hardened cutting edges to cut even the hardest of materials.
- Precision machined joint for maximum power transmission with optimum leverage for easy and effortless work.
- Ergonomic grip with softgrip for comfortable handling and good grip.



Description	Total length (mm)	Cutting capacity in very hard wire 2300N/mm ² [Max. Ø mm]	Cutting capacity in hard wire 1800N/mm ² [Max. Ø mm]	Cutting capacity in soft wire 220N/mm ² [Max. Ø mm]	Cutting capacity in cable Al and Cu [Max. Ø mm]	Capacity (mm)	Capacity pipe [Max. Weight (g) Ø mm]	Pack quantity	Min. order quantity	Article Number	EAN Code	
① VDE cable cutter	160	-	-	-	16	-	-	185	1	1	4932464562	4058546225070
	210	-	-	-	25	-	-	315	1	1	4932464563	4058546225087
② VDE long round nose plier	205	-	2.2	3.9	-	-	-	200	1	1	4932464564	4058546225094
③ VDE long 45 deg. round nose pliers	205	-	2.2	3.9	-	-	-	200	1	1	4932464565	4058546225100
④ VDE diagonal cutter	145	-	1.7	5	8	-	-	160	1	1	4932464566	4058546225117
	160	-	2	6	11	-	-	210	1	1	4932464567	4058546225124
	180	-	2.5	7	13	-	-	240	1	1	4932464568	4058546225131
⑤ VDE heavy duty diagonal cutter	180	2.2	2.6	7	13	-	-	250	1	1	4932464569	4058546225148
	200	2.5	2.8	8	15	-	-	305	1	1	4932464570	4058546225155
⑥ VDE combination plier	165	-	2	4	10	-	-	180	1	1	4932464571	4058546225162
	180	-	2.2	5.2	12	-	-	250	1	1	4932464572	4058546225179
⑦ VDE wire stripping plier	160	-	-	-	0.75mm ² - 6mm ²	-	-	180	1	1	4932464573	4058546225186
⑧ VDE water pump plier	240	-	-	-	-	50	50	395	1	1	4932464574	4058546225193
⑨ VDE Plier Set (3 pc) - Diagonal cutter (160 mm), long nose plier (205 mm), combi plier (180 mm)								660	3	1	4932464575	4058546225209

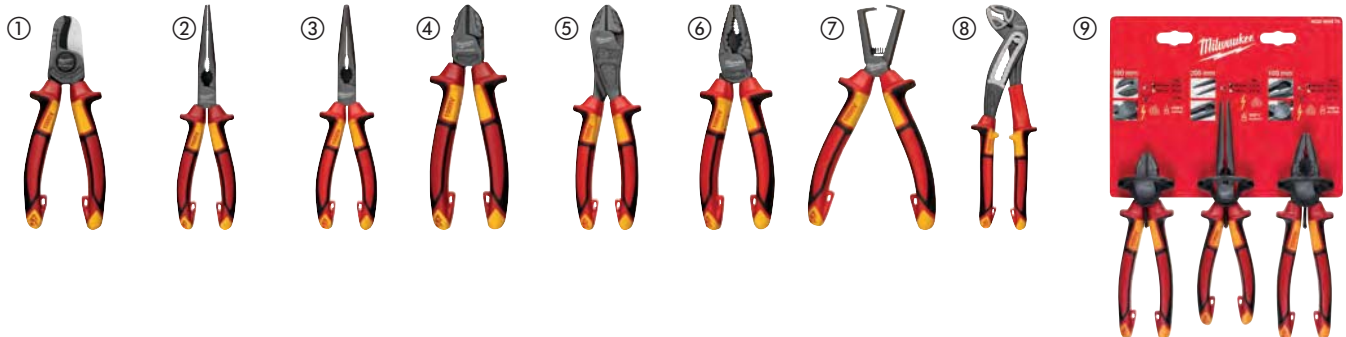

Nipping pliers

- Iron carbide edge: Longer blade life.
- Comfort grips: More comfortable than dipped plastic. Grips will not peel.
- Smooth head: Will not mark surface during pull / pry applications.
- Forged design: Tool durability in abusive environments.
- Rust protection: Black oxide finish protect from rust.

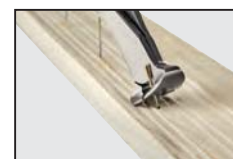

Description	Length (mm)	Pack quantity	Min. order quantity	Article Number	EAN Code
Nipping pliers	180	1	1	48226407	045242356096

7 in 1 wire stripping pliers

NEW

- Wire stripper : Strips wire sizes 0.75 mm², 1.0 mm², 1.5 mm², 2.5 mm², 4.0 mm², 6.0 mm².
- Wire cutter: With curved laser hardened cutting edges.
- Plier suitable for gripping and bending cables.
- Reaming head for smoothing 12 - 25 mm pipe.
- Loop maker: Built in loop maker function for wire.
- Integrated Crimper
- Integrated Bolt Cutter
- One-handed swing lock: Easy one-handed use and remains locked while in pouch. Spring loaded for easy opening.
- Rust protection increases tool life by reducing corrosion.



Description	Stripping capacities (mm ²)	Cutting capacity in hard wire 1800N/mm ² [Max. Ø mm]	Cutting capacity in cable Al and Cu (Max. Ø mm)	Deburring head max. Ø (mm)	Pack quantity	Min. order quantity	Article Number	EAN Code
7 in 1 Combination Plier	0.75, 1.0, 1.5, 2.5, 4.0, 6.0	2.5	6.0	25mm	1	1	4932478554	4058546347475

Heavy Duty Lineman's pliers

- For universal gripping, cutting applications.
- High leverage design: Long handles for maximum cutting power and leverage.
- Deburrer: Deburring ribs on head for up to 25 mm pipe. No need for extra tools.
- Nail puller: Powerful gripping and high leverage.
- Laser hardened durable cutting edges: Cuts wire, bolts, screws and nails. Extra hardened jaws to 64 HRC.
- Serrated gripping zone for strong gripping and pulling.
- Made from Chrome Vanadium steel for best durability and good rust protection.
- Ergonomic and durable overmoulded grips add comfort and last longer.
- With crimping facility.



Cut cap. in hard wire (mm)	Cutting capacity soft wire (mm)	Total length (mm)	Weight (g)	Deburring head max. Ø (mm)	Pack quantity	Min. order quantity	Article Number	EAN Code
3.0	4.6	250	480	25	1	1	48226100	045242342228

Long nose pliers

- Long nose pliers: Specially suitable for gripping, bending and adjusting in restricted areas.
- Wire cutter: Cuts wires up to 2.5 mm.
- Deburrer: Deburring ribs on head for up to 20 mm pipe. No need for extra tools.
- Nail puller
- Serrated jaws for better grip and excellent control.
- Laser hardened durable cutting edges. Extra hardened to 64 HRC.
- Made from Chrome Vanadium for best durability and good rust protection.
- Ergonomic and durable overmoulded grips add comfort and last longer.



Total length (mm)	Cut cap. in hard wire (mm)	Cable diameter (mm)	Jaw length (mm)	Weight (g)	Deburring head max. Ø (mm)	Pack quantity	Min. order quantity	Article Number	EAN Code
210	2.5	6.0	51	255	18	1	1	48226101	045242342211

Diagonal pliers

- For all around cutting use.
- Tip protection: Tips are off set ground to protect cutting edges from damage when dropped.
- High leverage design: Long handles for maximum cutting power and leverage.
- Deburrer: Deburring ribs on head for up to 25 mm pipe. No need for extra tools.
- 15° offset head allows flush cutting, can be used as a nail puller for easier and quicker prying and pulling.
- Laser hardened durable cutting edges. Extra hardened to 64 HRC. Cuts wire, bolts, screws and nails.
- Made from forged alloy Chrome Vanadium steel for best durability and good rust protection.
- Ergonomic and durable overmoulded grips add comfort and last longer.



Total length (mm)	Cut cap. in hard wire (mm)	Cutting capacity soft wire (mm)	Jaw length (mm)	Weight (g)	Pack quantity	Min. order quantity	Article Number	EAN Code
160	2.5	4.0	22	195	1	1	48226106	045242342181
180	3.0	4.0	26	246	1	1	48226107	045242342198

Quick adjust water pump pliers

- For gripping, fastening and holding work pieces.
- One hand push button adjustment for fast and firm grip.
- Fine scale adjustment positions for precise grip. Less downtime and more efficiency.
- Self locking button for fast and firm adjustment.
- V-groove jaws with profile for firmer grip, more precise fit and reduced slipping. Special teeth hardening 60 HRC.
- Made from Nickel and Chrome forged alloy steel for best durability and good rust protection.
- Ergonomic and durable overmoulded grips add comfort and last longer.
- Deburring head and handle design. No need for extra tools.
- Available in 3 lengths for optimum leverage.
- Ergonomic slim design to allow access in confined areas.

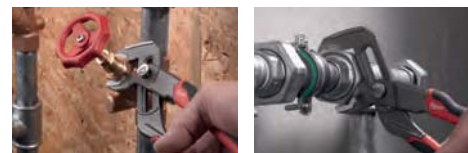

Total length (mm)	Total length (inch)	Max. nut size AF (mm)	Max. capacity tube & pipe Ø (mm)	Weight (g)	Deburring head max. Ø (mm)	Deburring handles max. Ø (mm)	Pack quantity	Min. order quantity	Article Number	EAN Code
200	8	30	32	250	38	25	1	1	48226208	045242342235
250	10	36	42	425	51	25	1	1	48226210	045242342242
300	12	50	60	660	70	25	1	1	48226212	045242342259

TORQUE LOCK™ locking pliers

- TORQUE LOCK™: Faster set up and easy release when clamping flat and round material. Extra force can be applied to the TORQUE LOCK™ screw for better and more secure grip. Can also be used for hanging / storage purposes.
- Hardened jaws: Better grip force on jobsite material.
- Rust protection: Chrome plated tool increases life by reducing corrosion.
- Lever release design: Traditional release lever for jobsite convenience.

	Total length (mm)	Total length (inch)	Jaw type	Jaw capacity flat (mm)	Jaw opening capacity for pipe (mm)	Pack quantity	Min. order quantity	Article Number	EAN Code
①	170	7	MAXBITE™	-	38	1	1	4932471730	4058546296292
②	250	10	MAXBITE™	-	50	1	1	4932471729	4058546296285
③	127	5	curved	-	26	1	1	4932472263	4058546339098
④	170	7	curved	-	38	1	1	4932471732	4058546296315
⑤	250	10	curved	-	51	1	1	4932471725	4058546296247
⑥	250	10	flat	30	-	1	1	4932471726	4058546296254
⑦	100	4	flat long nose	42	-	1	1	4932472262	4058546339081
⑧	150	6	flat long nose	52	-	1	1	4932471731	4058546296308
⑨	230	9	flat long nose	76	-	1	1	4932471733	4058546296322

TORQUE LOCK™



TORQUE LOCK™ locking C clamps

- TORQUE LOCK™: Faster set up and easy release when clamping flat and round materials for welding. Extra force can be applied to the TORQUE LOCK™ screw for better and more secure grip. Can also be used for hanging / storage purposes.
- Hardened jaws: Better grip force on jobsite material.
- Rust protection: Chrome plated tool increases life by reducing corrosion.
- Lever release design: Traditional release lever for jobsite convenience.



	Total length (mm)	Total length (inch)	Jaw type	Jaw capacity flat (mm)	Pack quantity	Min. order quantity	Article Number	EAN Code
①	230	9	Deep reach regular pointed pads	114	1	1	4932472257	4058546339036
②	480	18	Deep reach regular pointed pads	170	1	1	4932472259	4058546339050
③	280	11	Regular pointed pads	90	1	1	4932471728	4058546296278
④	480	18	Regular pointed pads	170	1	1	4932472260	4058546339067
⑤	230	9	Deep reach swivel pads	114	1	1	4932472258	4058546339043
⑥	280	11	Swivel pads	100	1	1	4932471727	4058546296261
⑦	480	18	Swivel pads	170	1	1	4932472261	4058546339074

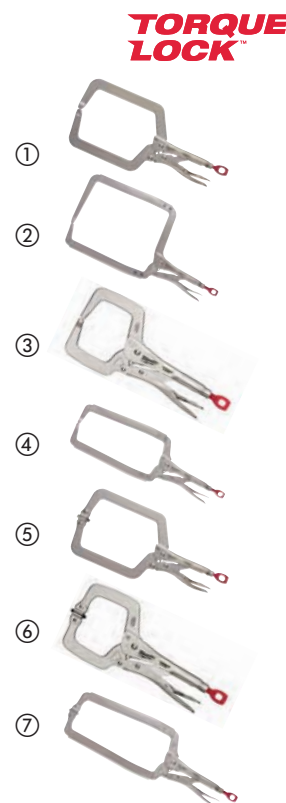

TORQUE LOCK™ seamer

- TORQUE LOCK™: Faster set up and easy release when clamping flat material. Extra force can be applied to the TORQUE LOCK™ screw for better and more secure grip. Can also be used for hanging / storage purposes.
- Hardened jaws: Better grip force on jobsite material.
- Rust protection: Chrome plated tool increases life by reducing corrosion.
- Lever release design: Traditional release lever for jobsite convenience.
- The seamer makes all kinds of bendings, forming, crimping tasks with ease.
- It is ideal for holding sheet metal parts.



Description	Total length (mm)	Total length (inch)	Jaw capacity flat (mm)	Pack quantity	Min. order quantity	Article Number	EAN Code
TORQUE LOCK™ seamer	200	8	42	1	1	4932471734	4058546296339

TORQUE LOCK™ chain wrench

- TORQUE LOCK™: Faster set up and easy release when clamping round material. Extra force can be applied to the TORQUE LOCK™ screw for better and more secure grip. Can also be used for hanging / storage purposes.
- Rust protection: Chrome plated tool increases life by reducing corrosion.
- Lever release design: Traditional release lever for jobsite convenience.
- Locking chain wrench holds and locks around any shape object.
- It adjusts quickly for ratchet action in either direction.



Description	Total length (mm)	Total length (inch)	Jaw opening capacity for pipe (mm)	Pack quantity	Min. order quantity	Article Number	EAN Code
TORQUE LOCK™ chain wrench	270	9	79	1	1	48223542	045242472727

MAX Bite™ combination spanner

NEW

- MAX BITE™ open-end grip reduces rounding and stripping.
- Rounded I-Beam handle for comfortable handling grip.
- Ink-filled labels for better visibility.
- 15° offset box for better accessibility.



Description	Total length (mm)	Pack quantity	Min. order quantity	Article Number	EAN Code
8mm Maxbite Combination Spanner	140mm	1	1	4932471516	4058546294151
9mm Maxbite Combination Spanner	150mm	1	1	4932471517	4058546294168
10mm Maxbite Combination Spanner	158mm	1	1	4932471518	4058546294175
11mm Maxbite Combination Spanner	165mm	1	1	4932471519	4058546294182
12mm Maxbite Combination Spanner	172mm	1	1	4932471520	4058546294199
13mm Maxbite Combination Spanner	180mm	1	1	4932471521	4058546294205
14mm Maxbite Combination Spanner	190mm	1	1	4932471522	4058546294212
15mm Maxbite Combination Spanner	200mm	1	1	4932471523	4058546294229
16mm Maxbite Combination Spanner	210mm	1	1	4932471524	4058546294236
17mm Maxbite Combination Spanner	225mm	1	1	4932471525	4058546294243
18mm Maxbite Combination Spanner	235mm	1	1	4932471526	4058546294250
19mm Maxbite Combination Spanner	250mm	1	1	4932471527	4058546294267
20mm Maxbite Combination Spanner	262mm	1	1	4932471528	4058546294274
21mm Maxbite Combination Spanner	272mm	1	1	4932471529	4058546294281
22mm Maxbite Combination Spanner	295mm	1	1	4932471530	4058546294298

TiD-extra
 Industrial Technologies d.o.o.

MAX BITE™ combination spanner sets

- MAX BITE™ open-end grip reduces rounding and stripping.
- Rounded I-Beam handle for comfortable handling grip.
- Optimised storage: 7 pc set with carry handle, 15 pc set in tray for easy storage and connection to tool roller cabinet drawers.
- Ink-filled labels for better visibility.
- 15° offset box for better accessibility.
- Chrome alloy steel, chrome plated.

Description	Pack quantity	Min. order quantity	Article Number	EAN Code
MAX BITE™ metric combination spanner set (7pc) ① 8, 10, 12, 13, 14, 15, 17 mm	7	1	4932464257	4058546222024
MAX BITE™ metric combination spanner set (15pc) ② 8, 9, 10, 11, 12, 13, 14, 15, 16, 17, 18, 19, 20, 21, 22 mm	15	1	4932464258	4058546222031
MAX BITE™ imperial combination spanner set (7pc) ③ $\frac{3}{8}$ " $\frac{7}{16}$ " $\frac{1}{2}$ " $\frac{9}{16}$ " $\frac{5}{8}$ " $\frac{11}{16}$ " $\frac{3}{4}$ "	7	1	48229407	045242499038
MAX BITE™ imperial combination spanner set (15pc) ④ $\frac{1}{4}$ " $\frac{9}{32}$ " $\frac{5}{16}$ " $\frac{11}{32}$ " $\frac{3}{8}$ " $\frac{7}{16}$ " $\frac{1}{2}$ " $\frac{9}{16}$ " $\frac{5}{8}$ " $\frac{11}{16}$ " $\frac{3}{4}$ " $\frac{13}{16}$ " $\frac{7}{8}$ " $\frac{15}{16}$ " 1"	15	1	48229415	045242499021



MAX BITE™ ratcheting combination spanner

NEW

- 144 Ratcheting teeth positions giving 2.5° arc swing allowing access in tighter spaces.
- Durable double stacked pawls for longer ratchet life.
- MAX BITE™ open-end grip reduces rounding and stripping.
- Rounded I-Beam handle for comfortable handling grip.
- Ink-filled labels for better visibility.
- Chrome alloy steel, chrome plated.



Description	Total length (mm)	Pack quantity	Min. order quantity	Article Number	EAN Code
8mm Maxbite Ratcheting Combination Spanner	146mm	1	1	4932471501	4058546294007
9mm Maxbite Ratcheting Combination Spanner	156mm	1	1	4932471502	4058546294014
10mm Maxbite Ratcheting Combination Spanner	165mm	1	1	4932471503	4058546294021
11mm Maxbite Ratcheting Combination Spanner	171.5mm	1	1	4932471504	4058546294038
12mm Maxbite Ratcheting Combination Spanner	178.5mm	1	1	4932471505	4058546294045
13mm Maxbite Ratcheting Combination Spanner	186.5mm	1	1	4932471506	4058546294052
14mm Maxbite Ratcheting Combination Spanner	198mm	1	1	4932471507	4058546294069
15mm Maxbite Ratcheting Combination Spanner	207.5mm	1	1	4932471508	4058546294076
16mm Maxbite Ratcheting Combination Spanner	218mm	1	1	4932471509	4058546294083
17mm Maxbite Ratcheting Combination Spanner	233.5mm	1	1	4932471510	4058546294090
18mm Maxbite Ratcheting Combination Spanner	242.5mm	1	1	4932471511	4058546294106
19mm Maxbite Ratcheting Combination Spanner	257.5mm	1	1	4932471512	4058546294113
20mm Maxbite Ratcheting Combination Spanner	272mm	1	1	4932471513	4058546294120
21mm Maxbite Ratcheting Combination Spanner	282mm	1	1	4932471514	4058546294137
22mm Maxbite Ratcheting Combination Spanner	303mm	1	1	4932471515	4058546294144

MAX BITE™ ratcheting combination spanner sets

- 144 Ratcheting teeth positions giving 2.5° arc swing allowing access in tighter spaces.
- Durable double stacked pawls for longer ratchet life.
- MAX BITE™ open-end grip reduces rounding and stripping.
- Ink-filled labels for better visibility.
- Chrome alloy steel, chrome plated.
- Rounded I-Beam handle for comfortable handling grip.

Description	Pack quantity	Min. order quantity	Article Number	EAN Code
① MAX BITE™ ratcheting metric combination spanner set (7pc) 8, 10, 12, 13, 14, 15, 17 mm	7	1	4932464993	4058546229382
② MAX BITE™ ratcheting metric combination spanner set (15pc) 8, 9, 10, 11, 12, 13, 14, 15, 16, 17, 18, 19, 20, 21, 22 mm	15	1	4932464994	4058546229399

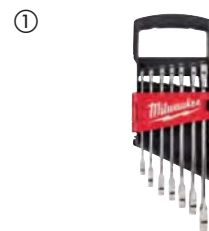

1/4" drive chrome sockets

NEW

- FOUR FLAT™ sides on socket deter rolling.
- Wrench ready FOUR FLAT™ sides.
- Stamped sizes for easy visibility.
- Chrome Finish.



Description	Pack quantity	Min. order quantity	Article Number	EAN Code
1/4" Drive - 5mm	1	1	4932478312	4058546345037
1/4" Drive - 5.5mm	1	1	4932478313	4058546345044
1/4" Drive - 6mm	1	1	4932478314	4058546345051
1/4" Drive - 7mm	1	1	4932478315	4058546345068
1/4" Drive - 8mm	1	1	4932478316	4058546345075
1/4" Drive - 9mm	1	1	4932478317	4058546345082
1/4" Drive - 10mm	1	1	4932478318	4058546345099
1/4" Drive - 11mm	1	1	4932478319	4058546345105
1/4" Drive - 12mm	1	1	4932478320	4058546345112
1/4" Drive - 13mm	1	1	4932478321	4058546345129
1/4" Drive - 14mm	1	1	4932478322	4058546345136
1/4" Drive - 15mm	1	1	4932478323	4058546345143
1/4" Deep Drive - 5mm	1	1	4932478324	4058546345150
1/4" Deep Drive - 5.5mm	1	1	4932478325	4058546345167
1/4" Deep Drive - 6mm	1	1	4932478326	4058546345174
1/4" Deep Drive - 7mm	1	1	4932478327	4058546345181
1/4" Deep Drive - 8mm	1	1	4932478328	4058546345198
1/4" Deep Drive - 9mm	1	1	4932478329	4058546345204
1/4" Deep Drive - 10mm	1	1	4932478330	4058546345211
1/4" Deep Drive - 11mm	1	1	4932478331	4058546345228
1/4" Deep Drive - 12mm	1	1	4932478332	4058546345235
1/4" Deep Drive - 13mm	1	1	4932478333	4058546345242
1/4" Deep Drive - 14mm	1	1	4932478334	4058546345259
1/4" Deep Drive - 15mm	1	1	4932478335	4058546345266



3/8" drive chrome sockets

NEW

- FOUR FLAT™ sides on socket deter rolling.
- Wrench ready FOUR FLAT™ sides.
- Stamped sizes for easy visibility.
- Chrome Finish.



Description	Pack quantity	Min. order quantity	Article Number	EAN Code
3/8" Drive - 6mm	1	1	4932478336	4058546345273
3/8" Drive - 7mm	1	1	4932478337	4058546345280
3/8" Drive - 8mm	1	1	4932478338	4058546345297
3/8" Drive - 9mm	1	1	4932478339	4058546345303
3/8" Drive - 10mm	1	1	4932478340	4058546345310
3/8" Drive - 11mm	1	1	4932478341	4058546345327
3/8" Drive - 12mm	1	1	4932478342	4058546345334
3/8" Drive - 13mm	1	1	4932478343	4058546345341
3/8" Drive - 14mm	1	1	4932478344	4058546345358
3/8" Drive - 15mm	1	1	4932478345	4058546345365
3/8" Drive - 16mm	1	1	4932478346	4058546345372
3/8" Drive - 17mm	1	1	4932478347	4058546345389
3/8" Drive - 18mm	1	1	4932478348	4058546345396
3/8" Drive - 19mm	1	1	4932478349	4058546345402
3/8" Deep Drive - 6mm	1	1	4932478350	4058546345419
3/8" Deep Drive - 7mm	1	1	4932478351	4058546345426
3/8" Deep Drive - 8mm	1	1	4932478352	4058546345433
3/8" Deep Drive - 9mm	1	1	4932478353	4058546345440
3/8" Deep Drive - 10mm	1	1	4932478354	4058546345457
3/8" Deep Drive - 11mm	1	1	4932478355	4058546345464
3/8" Deep Drive - 12mm	1	1	4932478356	4058546345471
3/8" Deep Drive - 13mm	1	1	4932478357	4058546345488
3/8" Deep Drive - 14mm	1	1	4932478358	4058546345495
3/8" Deep Drive - 15mm	1	1	4932478359	4058546345501
3/8" Deep Drive - 16mm	1	1	4932478360	4058546345518
3/8" Deep Drive - 17mm	1	1	4932478361	4058546345525
3/8" Deep Drive - 18mm	1	1	4932478362	4058546345532
3/8" Deep Drive - 19mm	1	1	4932478363	4058546345549



Ratchet and socket sets

- 90 tooth design with 4 degrees of arc swing for tight work spaces.
- Comes with a removable inner tray perfectly designed to be stored.
- Sockets are stamped with measurements on the flat side for easy-to-read visibility.
- All metal design for maximum durability.
- FOUR FLAT™ sides on socket deter rolling.
- Slim profile head with flush direction lever offers better accessibility.



Description	Pack quantity	Min. order quantity	Article Number	EAN Code
① Metric 1/4" ratchet + socket set (28pc) Standard sockets: 5 mm, 5.5 mm, 6 mm, 7 mm, 8 mm, 9 mm, 10 mm, 11 mm, 12 mm, 13 mm, 14 mm, 15 mm / Deep well sockets: 5 mm, 5.5 mm, 6 mm, 7 mm, 8 mm, 9 mm, 10 mm, 11 mm, 12 mm, 13 mm, 14 mm, 15 mm	28	1	4932464943	4058546228880
② Metric & imperial 1/4" ratchet + socket set (50pc) Standard sockets: 5/32", 3/16", 7/32", 1/4", 9/32", 5/16", 11/32", 3/8", 7/16", 1/2", 9/16", 5 mm, 5.5 mm, 6 mm, 7 mm, 8 mm, 9 mm, 10 mm, 11 mm, 12 mm, 13 mm, 14 mm, 15 mm / Deep well socket: 5/32", 3/16", 7/32", 1/4", 9/32", 5/16", 11/32", 3/8", 7/16", 1/2", 9/16", 5 mm, 5.5 mm, 6 mm, 7 mm, 8 mm, 9 mm, 10 mm, 11 mm, 12 mm, 13 mm, 14 mm, 15 mm	50	1	4932464944	4058546228897
③ Metric 3/8" ratchet + socket set (32pc) Standard sockets: 6 mm, 7 mm, 8 mm, 9 mm, 10 mm, 11 mm, 12 mm, 13 mm, 14 mm, 15 mm, 16 mm, 17 mm, 18 mm, 19 mm / Deep well sockets: 6 mm, 7 mm, 8 mm, 9 mm, 10 mm, 11 mm, 12 mm, 13 mm, 14 mm, 15 mm, 16 mm, 17 mm, 18 mm, 19 mm	32	1	4932464945	4058546228903
④ Metric & imperial 3/8" ratchet + socket set (56pc) Standard sockets: 1/4", 5/16", 3/8", 7/16", 1/2", 9/16", 5/8", 11/16", 3/4", 13/16", 7/8", 15/16", 6 mm, 7 mm, 8 mm, 9 mm, 10 mm, 11 mm, 12 mm, 13 mm, 14 mm, 15 mm, 16 mm, 17 mm, 18 mm, 19 mm / Deep well sockets: 1/4", 5/16", 3/8", 7/16", 1/2", 9/16", 5/8", 11/16", 3/4", 13/16", 7/8", 15/16", 6 mm, 7 mm, 8 mm, 9 mm, 10 mm, 11 mm, 12 mm, 13 mm, 14 mm, 15 mm, 16 mm, 17 mm, 18 mm, 19 mm	56	1	4932464946	4058546228910
⑤ Metric 1/2" ratchet + socket set (28pc) Standard sockets: 10 mm, 11 mm, 12 mm, 13 mm, 14 mm, 15 mm, 16 mm, 17 mm, 18 mm, 19 mm, 20 mm, 21 mm, 22 mm, 23 mm, 24 mm / Deep well sockets: 10 mm, 11 mm, 12 mm, 13 mm, 14 mm, 15 mm, 16 mm, 17 mm, 18 mm, 19 mm / 3" extension, 5" extension & removable storage tray	28	1	4932471864	4058546297633



Ratchets

- 90 tooth design with 4 degrees of arc swing for tight work spaces.
- Slim profile head with flush direction lever offers better accessibility.

Description	Pack quantity	Min. order quantity	Article Number	EAN Code
1/4" drive ratchet	1	1	48229014	045242513017
3/8" drive ratchet	1	1	48229038	045242513024
1/2" drive ratchet	1	1	4932471865	4058546297640



1/2" drive breaker bar

- Provides Extra leverage for tougher bolts.
- 180° swiveling head

Description	Total length (mm)	Total length (inch)	Article Number	EAN Code
1/2" drive breaker drive (15)	380	15	4932471866	4058546297657
1/2" drive breaker drive (24)	610	24	4932471867	4058546297664



Tradesman 3/8" ratchet set

- Pivoting ratchet head.
- Slim profile design for better access.
- Square shaped sockets compatible with combination spanners.
- Organised and portable storage solution.

Description	Pack quantity	Min. order quantity	Article Number	EAN Code
Tradesman 3/8" ratchet set (12pc)				
3/8" sockets: 10, 12, 13, 14, 15, 17, 18 and 19 mm. 3/8" ratchet. 152 mm extension. 1/4" to 3/8" adaptor and 3/8" to 1/4" adaptor	12	1	48229001	045242495078



Steel and aluminium pipe wrenches

- Overbite jaw for secure grip on pipes and fittings.
- Dual coil springs for maximum durability and tool life.
- Ergonomic handle for maximum comfort, won't dig into the palm.
- Hardened jaws for increased durability and better grip.
- Lanyard hole.

Description	Total length (mm)	Total length (inch)	Jaw opening capacity for pipe (mm)	Jaw opening capacity for pipe (inch)	Weight (g)	Pack quantity	Min. order quantity	Article Number	EAN Code
Aluminium pipe wrench 250 mm	250	10	38	1.5	598	1	1	48227210	045242342372
Aluminium pipe wrench 300 mm	300	12	51	2	816	1	1	48227212	045242342389
① Aluminium pipe wrench 350 mm	350	14	51	2	1076	1	1	48227214	045242342396
Aluminium pipe wrench 450 mm	450	18	63	2.5	1630	1	1	48227218	045242342419
Aluminium pipe wrench 600 mm	600	24	76	3	2644	1	1	48227224	045242342426
Steel pipe wrench 250 mm	250	10	38	1.5	916	1	1	48227110	045242342334
② Steel pipe wrench 300 mm	300	12	51	2	1270	1	1	48227112	045242342341
Steel pipe wrench 350 mm	350	14	51	2	1627	1	1	48227114	045242342358
Steel pipe wrench 450 mm	450	18	63	2.5	2531	1	1	48227118	045242342365



CHEATER - adaptable pipe wrench

- New-to-world 3 length design - 10"/250 mm mode for tight spaces, 18"/450 mm mode for general purpose, 24"/600 mm mode for maximum leverage and reach.
- Overbite jaw for secure grip on pipes and fittings.
- Dual coil springs for maximum durability and tool life.
- Ergonomic handle for maximum comfort, won't dig into the palm.
- Ergonomic hook jaw design - for easy detachment from the workpiece.
- Hardened jaws for increased durability and better grip.
- Lanyard hole.



Description	Total length (mm)	Total length (inch)	Jaw opening capacity for pipe (mm)	Jaw opening capacity for pipe (inch)	Weight (g)	Pack quantity	Min. order quantity	Article Number	EAN Code
-------------	-------------------	---------------------	------------------------------------	--------------------------------------	------------	---------------	---------------------	----------------	----------

Adaptable pipe wrench	250/450/600	10/18/24	63	2.5	3243	1	1	48227314	045242342402
-----------------------	-------------	----------	----	-----	------	---	---	----------	--------------



Adjustable wrenches

- Precision adjustment screw with accurate threads and tight tolerances. The jaws won't back off during use.
- Chrome plating for best-in-class rust protection and increased durability.
- Ergonomic rounded handle design for a comfortable fit in the hand and less pressure points on the palm.
- Slim head design for reaching into tight spaces.
- Parallel jaws won't slip or damage finish surfaces.
- Permanent lasered inch and mm markings for accurate adjustment.
- 8" adjustable wrench (48227508) has an extra wide jaw of 38 mm for increased jaw capacity in confined environments.
- Lanyard hole.



Total length (mm)	Total length (inch)	Jaw opening capacity for pipe (mm)	Jaw thickness (mm)	Tip thickness (mm)	Weight (g)	Pack quantity	Min. order quantity	Article Number	EAN Code
-------------------	---------------------	------------------------------------	--------------------	--------------------	------------	---------------	---------------------	----------------	----------

150	6	24.5	11.5	7,7	186	1	1	48227406	045242356225
200	8	30	14	8,7	353	1	1	48227408	045242356218
200	8	40	14	8,1	385	1	1	48227508	045242356232
250	10	36.5	16	9,9	535	1	1	48227410	045242356201
300	12	42.5	17	10,8	748	1	1	48227412	045242356195
380	15	46	22	13,5	1,470	1	1	48227415	045242356188
② 150 mm (48227406) + 250 mm (48227410)						2	1	48227400	045242358823



Basin wrench

- Ratchet-compatible design: Accepts 3/8" ratchet.
- Hi-leverage design: Achieve break-away torque on stuck fasteners.
- Door-knob handle: More comfortable than square.
- Easy to adjust handle: Best-in-class adjustability.



Description	Jaw size (mm)	Pack quantity	Min. order quantity	Article Number	EAN Code
Basin wrench compact	10 - 32	1	1	48227001	045242366170
Basin wrench	32 - 65	1	1	48227002	045242366187

S Jaw pipe wrench

- Made of forged chrome vanadium steel and oil hardened for durability according to DIN 5234.
- Slim, S shaped 45° angled jaws for best reach in confined areas.
- Assymmetric serrated induction hardened jaws for maximum grip.
- I beam handle design for maximum strength.



Total length (mm)	Capacity pipe [Max. Ø mm]	Weight (g)	Pack quantity	Min. order quantity	Article Number	EAN Code
340	52	965	1	1	4932464576	4058546225216
450	67	1570	1	1	4932464577	4058546225223
550	83	3000	1	1	4932464578	4058546225230

HOLLOWCORE™ magnetic nut drivers

- HOLLOWCORE™ unlimited depth in long bolts and threaded rod applications (patent pending).
- Magnetic retention driver heads for secure fitment in fastening applications.
- NEW TO WORLD universal driver head fits 4 x more fasteners - square, 12 point, 8 point, Hex.
- Removes rusted and stripped bolts.
- Colour coded ID markings allow for quick tool identification on jobsite.
- Wrench ready Hex shanks deliver additional leverage.
- Chrome plated for maximum durability.
- Forged steel shanks provide longer life and more durability.



Size (mm)	Colour code	For anchor thread size	Pack quantity	Min. order quantity	Article Number	EAN Code
① 5	Black	-	1	1	48222531	045242294428
② 5.5	Brown	M3	1	1	48222532	045242294435
③ 6	Red	M3.5	1	1	48222533	045242294442
④ 7	Orange	M4	1	1	48222534	045242294459
⑤ 8	Yellow	M5	1	1	48222535	045242294466
⑥ 10	Blue	M6	1	1	48222536	045242294473
⑦ 13	Orange	M8	1	1	48222537	045242294480



Fish tape

- High flexibility tape for easier feeding
- Thicker tape for better pushing
- Triple strand design, won't kink
- Low friction case for smooth pay out
- Square inner grip for easier winding

	Description	Length (m)	Pack quantity	Min. order quantity	Article Number	EAN Code
	Steel fish tape 7.5m	7.5	1	1	4932472120	4058546325169
①	Steel fish tape 15m	15	1	1	4932472121	4058546325176
	Polyester fish tape 15m	15	1	1	4932472118	4058546325145
②	Polyester fish tape 30m	30	1	1	4932472119	4058546325152

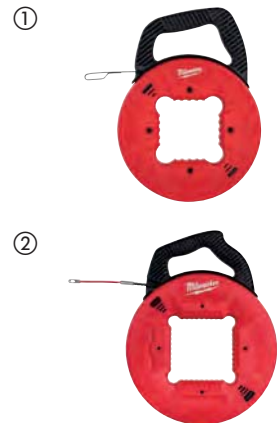

Hook & pick set

- All-metal core for more durability and rust protection.
- Chrome-plated shanks reduce corrosion and provide superior rust protection.
- Comfort grip handle and precision knurling increase tool control and user comfort.
- Supplied in an easy-access storage tray for long-term tool storage.



Description	Pack quantity	Min. order quantity	Article Number	EAN Code
Hook & pick set	4	1	48229215	045242508105

Pry bar set

- I-Beam design for up to 40% more prying strength.
- All-Metal Core for improved durability.
- Hammer-ready strike cap improves leverage when working in tight and tricky spaces.
- Comfortable Tri-Lobe Handles for better grip.
- All-chrome shafts for increased durability.
- Curved claw design reduces damage when pulling nails.

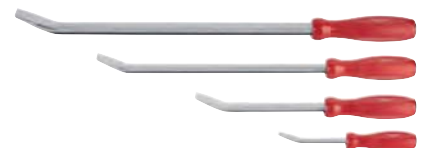

Contents	Pack quantity	Min. order quantity	Article Number	EAN Code
200mm - 300m - 450mm - 600mm	1	1	48229214	045242508099

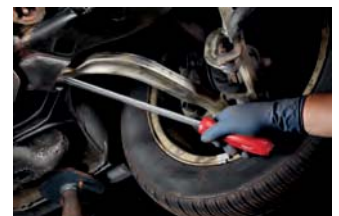

SAFETY SOLUTIONS



STAY SAFE. STAY PRODUCTIVE.

SAFETY
GLASSES

HIGH-VISIBILITY
VESTS

CUT RESISTANT &
SPECIAL APPLICATION
GLOVES

TOOL
LANYARDS

OVER
35
PPE SOLUTIONS

TiD-extra
Industrial Technologies

HAND TOOLS

Premium safety glasses with gasket

**COMFORTABLE, FLEXIBLE
ARMS FOR EXTENDED WEAR**



CE Certified for
EN166, EN170
& EN172

ANTI-SCRATCH LENSES



**LONG LASTING
ANTI-FOG LENSES**



**FLEXIBLE
NOSE PIECE**

**REMOVABLE
GASKET
PROTECTS
AGAINST DEBRIS**



**ALSO AVAILABLE IN TINTED
LENSES FOR OUTDOOR WORK**

INCLUDES A SOFT CASE

TiD-extra
Industrial Technologies d.o.o.

	Lens colour	Packaging style	Pack quantity	Min. order quantity	Article Number	EAN Code
①	Clear	Blister	1	6	4932471885	4058546297848
②	Polarised	Blister	1	6	4932471886	4058546297855



Performance safety glasses



CE Certified for
EN166, EN170
& EN172

- Durable anti-scratch lenses.
- Long lasting anti-fog lenses.
- Comfortable and flexible arms for extended comfort wear.
- Clear and tinted options offer eye protection whether working indoors or outdoors.
- European Certified: EN166 and EN170 / EN172.



	Lens colour	Packaging style	Pack quantity	Min. order quantity	Article Number	EAN Code
①	Clear	Blister packaging	1	6	4932471883	4058546297824
②	Tinted	Blister packaging	1	6	4932471884	4058546297831

Enhanced safety glasses

NEW



CE Certified for
EN166, EN170
& EN172

- Light weight for extended comfort while wearing.
- Durable anti-scratch lenses.
- Long lasting anti-fog lenses.
- Comfortable and flexible arms for extended comfort wear.
- Clear and tinted options offer eye protection whether working indoors or outdoors.
- European Certified: EN166 and EN170 / EN172.

	Lens colour	Packaging style	Pack quantity	Min. order quantity	Article Number	EAN Code
①	Clear	Polybag	1	12	4932478763	4058546360450
②	Tinted	Polybag	1	12	4932478764	4058546360467

Safety glasses



CE Certified for
EN166, EN170
& EN172

- Light weight for extended comfort while wearing.
- Fully adjustable and removable nose bridge to fit comfortably all face shapes.
- Comfortable and flexible arms for extended comfort wear.
- Clear and tinted options offer eye protection whether working indoors or outdoors.
- European Certified: EN166 and EN170 / EN172.



	Lens colour	Packaging style	Pack quantity	Min. order quantity	Article Number	EAN Code
①	Clear	Polybag	1	12	4932471881	4058546297800
②	Tinted	Polybag	1	12	4932471882	4058546297817

PREMIUM HIGH-VISIBILITY VEST

15 Storage Pockets

External:

- 2 Mic Tabs
- 1 Clear ID Holder
- 2 Chest Pockets
- 4 Reinforced Pen Pockets
- 2 Reinforced Barrel Pockets
- 1 Tablet Pocket

Internal:

- 1 Chest Pocket
- 2 Barrel Pockets



TiD-extra
 Industrial Technologies d.o.o.

Premium high-visibility vest yellow

NEW

- 15 pockets - increased carrying capacity.
- 1 clear ID badge holder - easy identification on the jobsite.
- 1 back pocket - ideal to carry tablet or notebook.
- Quick internal size adjustment - size up or size down for better fit.
- Padded collar - added comfort for extended wear.
- Harness tethering hole - ideal to fit over harness to add more safety on the jobsite.
- European Certified as Class 2 High Visibility Clothing according to EN 20471: 2013/A1:2016.



Description	Colour	Pack quantity	Min. order quantity	Article Number	EAN Code
Premium high-visibility vest yellow - S/M	Yellow	1	1	4932471895	4058546297947
Premium high-visibility vest yellow - L/XL	Yellow	1	1	4932471896	4058546297954
Premium high-visibility vest yellow - 2XL/3XL	Yellow	1	1	4932471897	4058546297961

Premium high-visibility vest orange

NEW

Description	Colour	Pack quantity	Min. order quantity	Article Number	EAN Code
Premium high-visibility vest orange - S/M	Orange	1	1	4932471898	4058546297978
Premium high-visibility vest orange - L/XL	Orange	1	1	4932471899	4058546297985
Premium high-visibility vest orange - 2XL/3XL	Orange	1	1	4932471900	4058546297992



HIGH-VISIBILITY VEST

10 Storage Pockets

External:

- 2 Mic Tabs
- 1 Clear ID Holder
- 2 Chest Pockets
- 4 Reinforced Pen Pockets

Internal:

- 1 Chest Pocket



TiD-extra
 Industrial Technologies d.o.o.

High-visibility vest yellow

NEW

- 10 pockets - increased carrying capacity.
- 1 clear ID badge holder - easy identification on the jobsite.
- Quick internal size adjustment - size up or size down for better fit.
- Harness tethering hole - ideal to fit over harness to add more safety on the jobsite.
- European Certified as Class 2 High Visibility Clothing according to EN 20471: 2013/A1:2016.



Description	Colour	Pack quantity	Min. order quantity	Article Number	EAN Code
High-visibility vest yellow - S/M	Yellow	1	1	4932471889	4058546297886
High-visibility vest yellow - L/XL	Yellow	1	1	4932471890	4058546297893
High-visibility vest yellow - 2XL/3XL	Yellow	1	1	4932471891	4058546297909

High-visibility vest orange

NEW

Description	Colour	Pack quantity	Min. order quantity	Article Number	EAN Code
High-visibility vest orange - S/M	Orange	1	1	4932471892	4058546297916
High-visibility vest orange - L/XL	Orange	1	1	4932471893	4058546297923
High-visibility vest orange - 2XL/3XL	Orange	1	1	4932471894	4058546297930



HAND TOOLS



Nothing but **HEAVY DUTY.**[™]



MILWAUKEE[®] GLOVES GUIDE

GLOVE TYPES

CUT RESISTANT GLOVES



WINTER CUT RESISTANT GLOVES



	CUT LEVEL A	CUT LEVEL C	HI-VIS CUT LEVEL C	CUT LEVEL E	WINTER CUT LEVEL A	WINTER CUT LEVEL C
FEATURES						
EN 388 RATING	3121A	4343C	4442C	4X44E	EN388: 1141A EN511: 01X	EN388: 2442C EN511: 02X
APPLICATIONS						
AUTO MECHANICAL	✓	✓	✓		✓	✓
CARPENTER	✓		✓		✓	
CONSTRUCTION WORK	✓	✓	✓	✓	✓	✓
DEMOLITION						
ELECTRICAL	✓	✓	✓			✓
GLASS HANDLING				✓		
HVAC		✓	✓	✓		✓
MATERIAL HANDLING	✓		✓		✓	
MRO	✓	✓	✓		✓	✓
OFF SHORE / OIL & GAS		✓				
PIPE THREADING		✓	✓	✓		✓
PLUMBING	✓		✓		✓	
SHEET METAL				✓		
UTILITY WIRE STRIPPING		✓	✓	✓		✓
SIZES						
MEDIUM / 8	4932471416	4932471420	4932478131	4932471424	4932471343	4932471347
LARGE / 9	4932471417	4932471421	4932478132	4932471425	4932471344	4932471348
EXTRA LARGE / 10	4932471418	4932471422	4932478133	4932471426	4932471345	4932471349
EXTRA EXTRA LARGE / 11	4932471419	4932471423	4932478134	4932471427	4932471346	4932471350

TiD-extra
Industrial Technologies
d.o.o.

RESISTANCE TO CUT AND ABRASION

CUT LEVEL E

Double layer nitrile creates the ideal glove for handling sharp objects.

CUT LEVEL C

Ideal for stripping wire or pipe threading and cutting.

CUT LEVEL A

Ideal for material handling and light constructions duty.

FEATURES KEY



WORK GLOVES

IMPACT GLOVES

LEATHER GLOVES



WORK GLOVES			IMPACT GLOVES		LEATHER GLOVES	
FREE FLEX	FINGERLESS	DEMOLITION	IMPACT DEMOLITION	IMPACT CUT LEVEL C	HYBRID LEATHER	LEATHER
2121X	2121X	2121X	2121XP	4343CP	2122X	2122X
	✓		✓	✓		
✓	✓				✓	✓
✓	✓	✓	✓	✓	✓	✓
✓	✓	✓	✓	✓		
✓	✓				✓	✓
✓	✓				✓	✓
✓	✓	✓	✓	✓	✓	✓
✓	✓					
✓	✓	✓	✓	✓		
		✓				
		✓	✓			
48229711	48229741	48229731	4932471908	4932478127	4932471912	4932478123
48229712	48229742	48229732	4932471909	4932478128	4932471913	4932478124
48229713	48229743	48229733	4932471910	4932478129	4932471914	4932478125
48229714	48229744	48229734	4932471911	4932478130	4932471915	4932478126

GLOVE SIZING CHART

TiD-extra
Industrial Technologies d.o.o.

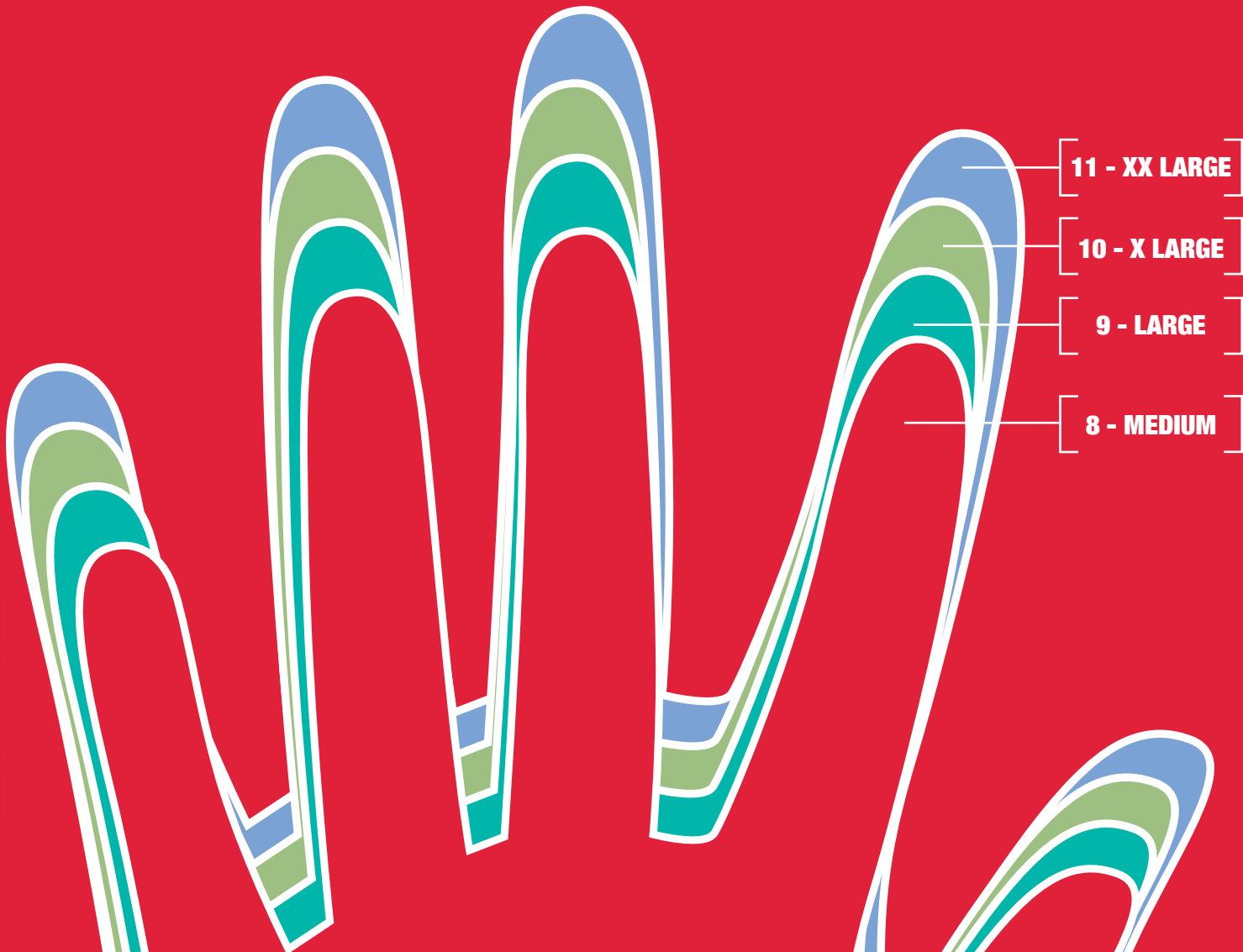

The correct fitting of work gloves is extremely important. Too big or too small and it can result in an uncomfortable fit. This in turn can result in hand fatigue and ultimately it could lead to a potential workplace hazard.

To minimise hand fatigue and possible workplace hazards, measure your hand to find the correct size of MILWAUKEE® glove for you.

SIZE	LENGTH	WIDTH
8 - MEDIUM	20cm	22cm
9 - LARGE	23cm	23cm
10 - X LARGE	25cm	27cm
11 - XX LARGE	28cm	30cm

MEASURING GUIDANCE

Place your hand on the image to determine your correct glove size. The ball of your thumb should be just in front of the line as indicated. Keep your fingers straight.

Cut resistant dipped gloves

Description	Colour code	Size	Pack quantity	Min. order quantity	Article Number	EAN Code
① Cut level 1/A dipped gloves	White	8 / M	1	1	4932471416	4058546290443
			12	1	4932471614	4058546295134
		9 / L	1	1	4932471417	4058546290450
			12	1	4932471615	4058546295141
		10 / XL	1	1	4932471418	4058546290467
			12	1	4932471616	4058546295158
② Cut level 3/C dipped gloves	Black	8 / M	1	1	4932471420	4058546290481
			12	1	4932471618	4058546295172
		9 / L	1	1	4932471421	4058546290498
			12	1	4932471619	4058546295189
		10 / XL	1	1	4932471422	4058546290504
			12	1	4932471620	4058546295196
③ Hi-Vis cut level 3/C dipped gloves	Black	11 / XXL	1	1	4932471423	4058546290511
			12	1	4932471621	4058546295202
		8 / M	1	1	4932478131	4058546340643
		9 / L	1	1	4932478132	4058546340650
④ Cut level 5/E dipped gloves	Red	10 / XL	1	1	4932478133	4058546340667
			1	1	4932478134	4058546340674
		8 / M	1	1	4932471424	4058546290528
			12	1	4932471622	4058546295219
		9 / L	1	1	4932471425	4058546290535
			12	1	4932471623	4058546295226
⑤ Winter cut level 1/A dipped gloves	White	10 / XL	1	1	4932471426	4058546290542
			12	1	4932471624	4058546295233
		11 / XXL	1	1	4932471427	4058546290559
			12	1	4932471625	4058546295240
		8 / M	1	1	4932471343	4058546289713
			12	1	4932471606	4058546295059
⑥ Winter cut level 3/C dipped gloves	Black	9 / L	1	1	4932471344	4058546289720
			12	1	4932471607	4058546295066
		10 / XL	1	1	4932471345	4058546289737
			12	1	4932471608	4058546295073
		11 / XXL	1	1	4932471346	4058546289744
			12	1	4932471609	4058546295080
⑦ Winter cut level 3/C dipped gloves	Black	8 / M	1	1	4932471347	4058546289751
			12	1	4932471610	4058546295097
		9 / L	1	1	4932471348	4058546289768
			12	1	4932471611	4058546295103
		10 / XL	1	1	4932471349	4058546289775
			12	1	4932471612	4058546295110
⑧ Winter cut level 3/C dipped gloves	Black	11 / XXL	1	1	4932471350	4058546289782
			12	1	4932471613	4058546295127



CE certified for EN420 and EN388:2016 (3121A).



CE certification for EN420 and EN388:2016 (4343C).



NEW

CE certified for EN420 and EN388:2016 (4442C).



CE certified for EN420 and EN388:2016(4X44E).



CE certified for EN420, EN388:2016 (1141A) and EN511 (01X).



CE certified for EN420, EN388:2016(2442C) and EN511 (02X).

Impact cut level C gloves

NEW

- Impact resistant material on back of the hand and fingers reduces and absorbs shock.
- Reinforced nitrile coating with added protection between thumb and fingers.
- Excellent grip performance - nitrile material performs better than other materials in extreme temperatures and oily surfaces.
- SMARTSWIPE[™] palm and fingertips - allows the use of touch screen devices without removing gloves.
- European Certified for cut resistance protection including impact testing: EN420 and EN388:2016 (4343CP).



Description	Pack quantity	Min. order quantity	Article Number	EAN Code
Impact Cut Level 3 Dipped Gloves - 8/M - 1pc	1	1	4932478127	4058546340605
Impact Cut Level 3 Dipped Gloves - 9/L - 1pc	1	1	4932478128	4058546340612
Impact Cut Level 3 Dipped Gloves - 10/XL - 1pc	1	1	4932478129	4058546340629
Impact Cut Level 3 Dipped Gloves - 11/XXL - 1pc	1	1	4932478130	4058546340636



Impact demolition gloves

NEW

- Impact resistant material, on back of hand and fingers, to reduce and absorb shock.
- ARMORTEX[™] reinforced palms and finger tips: Increased durability and hand protection.
- Superior palm grip on oily and wet surfaces.
- European Certified for cut resistance protection including impact testing: EN420 and EN388:2016 (2121XP).



Description	Pack quantity	Min. order quantity	Article Number	EAN Code
Impact Demolition Gloves - M/8 - 1pc	1	1	4932471908	4058546298074
Impact Demolition Gloves - L/9 - 1pc	1	1	4932471909	4058546298081
Impact Demolition Gloves - XL/10 - 1pc	1	1	4932471910	4058546298098
Impact Demolition Gloves - XXL/11 - 1pc	1	1	4932471911	4058546298104



Hybrid leather gloves

NEW

- Smartswipe[™] - Allows the use of touch screen devices without removing the gloves on the index finger knuckle.
- Leather on the palm for extended durability and reinforced protection of hands.
- Synthetic leather on back of the hand to offer more dexterity and breathability while working.
- Reinforced palm for added comfort and protection while handling heavy objects.
- European Certified for cut resistance protection: EN420 and EN388:2016 (2122X).



Description	Pack quantity	Min. order quantity	Article Number	EAN Code
Hybrid Leather Gloves - M/8 - 1pc	1	1	4932471912	4058546298111
Hybrid Leather Gloves - L/9 - 1pc	1	1	4932471913	4058546298128
Hybrid Leather Gloves - XL/10 - 1pc	1	1	4932471914	4058546298135
Hybrid Leather Gloves - XXL/11 - 1pc	1	1	4932471915	4058546298142



Leather gloves

NEW

- Top grain goatskin leather gives extended durability and reinforced protection of hands.
- Reinforced palm provides added comfort and protection while handling heavy objects.
- Keystone thumb for comfortable fit and extended wear.
- Smartswipe[™] - Allows the use of touch screen devices without removing the gloves on the index finger knuckle.
- European Certified for cut resistance protection: EN420 and EN388:2016 (2122X).



Description	Pack quantity	Min. order quantity	Article Number	EAN Code
Leather Gloves - 8/M - 1pc	1	1	4932478123	4058546340568
Leather Gloves - 9/L - 1pc	1	1	4932478124	4058546340575
Leather Gloves - 10/XL - 1pc	1	1	4932478125	4058546340582
Leather Gloves - 11/XXL - 1pc	1	1	4932478126	4058546340599



Demolition gloves

- ARMORTEX™ reinforced palms and finger tips: Increased durability and hand protection.
- SMARTSWIPE™ Knuckle: Capacitive knuckle allows to use touch screen devices without removing gloves or using dirty fingertips.
- Breathable tri-cot lining: Provides ultimate comfort and breathability.
- Knuckle protection: TPR pad provides knuckle protection.
- Terry cloth thumb: Built in sweat/brow wipe.
- Hook & Loop closure for secure fit.
- Fulfill the requirements of CE Category 2, EN 420 and EN 388 – 2221.



Description	Pack quantity	Min. order quantity	Article Number	EAN Code
Demolition Gloves - M/8 - 1pc	1	1	48229731	045242479436
Demolition Gloves - L/9 - 1pc	1	1	48229732	045242479443
Demolition Gloves - XL/10 - 1pc	1	1	48229733	045242479450
Demolition Gloves - XXL/11 - 1pc	1	1	48229734	045242479467



Fingerless gloves

- Designed to provide ultimate dexterity when handling small objects.
- Reinforced palm and thumb seam.
- Lightweight, breathable backing.
- Moisture wicking lining provides all day comfort.
- Built-in sweat wipe.
- Hook & Loop closure for secure fit.
- Fulfill the requirements of CE Category 2, EN 420 and EN 388.



Description	Pack quantity	Min. order quantity	Article Number	EAN Code
Fingerless Gloves - M/8 - 1pc	1	1	48229741	045242508730
Fingerless Gloves - L/9 - 1pc	1	1	48229742	045242508747
Fingerless Gloves - XL/10 - 1pc	1	1	48229743	045242508754
Fingerless Gloves - XXL/11 - 1pc	1	1	48229744	045242508761



FREE-FLEX work gloves

- SMARTSWIPE™ knuckle, palm and fingertips.
- Flexible and elastic gloves.
- Lightweight, breathable backing.
- Reinforced thumb seam.
- High dexterity finger tips.
- Built-in sweat wipe.
- Fulfill the requirements of CE Category 2, EN 420 and EN 388.



Description	Pack quantity	Min. order quantity	Article Number	EAN Code
FREE-FLEX Gloves - M/8 - 1pc	1	1	48229711	045242508693
FREE-FLEX Gloves - L/9 - 1pc	1	1	48229712	045242508709
FREE-FLEX Gloves - XL/10 - 1pc	1	1	48229713	045242508716
FREE-FLEX Gloves - XXL/11 - 1pc	1	1	48229714	045242508723





Locking tool lanyards

- Superior shock absorption - gradually stop the tool if dropped.
- Double locking carabiner - ensures a secure connection that cannot become loose or slip off accidentally.
- Integrated swivel - prevents twists and tangles allowing increased mobility.
- Colour coded weight rating - easy identification of lanyard weight capacity.
- High versatility - lanyard accessories can be added to connect all tools to the lanyards.



Description	Bearing force (kg)	Colour code	Pack quantity	Min. order quantity	Article Number	EAN Code
① 4.5 kg locking tool lanyard	4.5	Red	1	1	4932471351	4058546289799
② 4.5 kg QUICK-CONNECT™ locking tool lanyard	4.5	Red	1	1	4932471429	4058546290573
③ 6.8 kg locking tool lanyard	6.8	Black	1	1	4932471352	4058546289805
④ 15.8 kg locking tool lanyard	15.8	Grey	1	1	4932471353	4058546289812



TOOL LANYARD ACCESSORIES

STAY SAFE. SECURE ANY TOOL.



EASILY CONNECT

- Creates a secure attachment point
- Different connection system (self-adhering tape or rings)

HIGH VERSATILITY

- Possibility to connect tools with or without lanyard holes
- Allows fast tool swap

Tool lanyard accessories

Description	Colour code	Bearing force (kg)	Pack quantity	Min. order quantity	Article Number	EAN Code
① 2.2 kg small QUICK-CONNECT™ accessory	White	2.2	3	1	4932471430	4058546290580
② 2.2 kg D-ring web attachment	White	2.2	5	1	4932471431	4058546290597
③ 3.6 m self-adhering tape	-	-	1	1	48228860	4058546290603
④ 38 mm split ring	-	1	5	1	4932471433	4058546290610
⑤ 50 mm split ring	-	1	5	1	4932471434	4058546290627
⑥ Anchoring strap	Green	22.7	1	1	4932472105	4058546325015

Wrist tool lanyard

- Secure and comfortable tools attachment to the wrist.
- Soft and adjustable strap - fits all wrist sizes with a hook and loop closure.
- Hang loop to securely attach all kind of tools - power tools, tapes, screwdrivers, etc.
- Wrist lanyard allows an easy access to tools in a tight environment or in repetitive work.
- Colour coded weight rating - easy identification of lanyard weight capacity.



Description	Bearing force (kg)	Colour code	Pack quantity	Min. order quantity	Article Number	EAN Code
Wrist lanyard	2.2	White	1	1	4932472107	4058546325039



Nothing but **HEAVY DUTY.**™

PACKOUT™

MODULAR STORAGE SYSTEM

VERSATILE, DURABLE

The MILWAUKEE® PACKOUT™ modular storage system revolutionises tool transportation, organisation and storage. Designed to provide users with the ability to interchange and interlock a wide assortment of heavy duty tool boxes, organisers and storage totes in multiple different configurations.



**FULLY
CUSTOMIZE
YOUR STORAGE**



**IMPACT
RESISTANT
BASE**



**IP65
RATED
PROTECTION**

TiD-extra
Industrial Technology d.o.o.

PACKOUT™ trolley box

- Part of the PACKOUT™ modular storage system.
- Constructed with impact resistant polymers for jobsite durability.
- 113 kg weight capacity.
- Industrial grade extension handle.
- Oversized Ø 228 mm all terrain wheels.
- IP65 rated weather seal to keep out rain and jobsite debris.
- Metal reinforced corners.
- Metal reinforced locking point.
- Interior organiser tray.
- Mounting location for the ONE-KEY™ TICK™.

Description	Dimensions (mm)	Pack quantity	Min. order quantity	Article Number	EAN Code
PACKOUT™ trolley box	560 x 410 x 480	1	1	4932464078	4058546220235



PACKOUT™ boxes

- Part of the PACKOUT™ modular storage system.
- Constructed with impact resistant polymers for jobsite durability.
- IP65 rated weather seal to keep out rain and jobsite debris.
- Metal reinforced corners.
- Metal reinforced locking point.
- Interior organiser trays.
- Mounting location for the ONE-KEY™ TICK™.
- Metal reinforced top handle for easier carrying (only on the large box).

Description	Dimensions (mm)	Pack quantity	Min. order quantity	Article Number	EAN Code
① PACKOUT™ large box	560 x 410 x 290	1	1	4932464079	4058546220242
② PACKOUT™ box	560 x 410 x 170	1	1	4932464080	4058546220259



PACKOUT™ 3 piece set

Contents	Pack quantity	Min. order quantity	Article Number	EAN Code
1 x PACKOUT™ trolley box, 1 x PACKOUT™ large box, 1 x PACKOUT™ box	3	1	4932464244	4058546221898



PACKOUT[™] organiser

- Part of the PACKOUT[™] modular storage system.
- Constructed with impact resistant polymers for jobsite durability.
- The interior features 10 removable & mountable bins that can be mounted onto common jobsite materials for easy access.
- IP65 rated weather seal to keep out rain and jobsite debris.
- No-travel bins seals to prevent the bins contents from migrating between bins during transport.



Description	Dimensions (mm)	Pack quantity	Min. order quantity	Article Number	EAN Code
PACKOUT [™] organiser	500 x 380 x 120	1	1	4932464082	4058546220273

PACKOUT[™] compact organiser

- Part of the PACKOUT[™] modular storage system.
- Constructed with impact resistant polymers for jobsite durability.
- The interior features 5 removable & mountable bins that can be mounted onto common jobsite materials for easy access.
- IP65 rated weather seal to keep out rain and jobsite debris.
- No-travel bins seals to prevent the bins contents from migrating between bins during transport.



Description	Dimensions (mm)	Pack quantity	Min. order quantity	Article Number	EAN Code
PACKOUT [™] compact organiser	250 x 380 x 120	1	1	4932464083	4058546220280

PACKOUT[™] slim organiser

- Part of the PACKOUT[™] modular storage system.
- Constructed with impact resistant polymers for jobsite durability.
- Interior features 2 large bins and 8 small bins. All bins contain dividers.
- No travel bin seals to prevent the bins contents from migrating between bins during transportation.
- IP 65 rated weather seal to keep out rain and jobsite debris.



Description	Dimensions (mm)	Pack quantity	Min. order quantity	Article Number	EAN Code
PACKOUT [™] slim organiser	500 x 380 x 65	1	1	4932471064	4058546286927

PACKOUT[™] compact slim organiser

- Part of the PACKOUT[™] modular storage system.
- Constructed with impact resistant polymers for jobsite durability.
- Interior features 1 large bin and 4 small bins. All bins contain dividers.
- No travel bin seals to prevent the bins contents from migrating between bins during transportation.
- IP 65 rated weather seal to keep out rain and jobsite debris.



Description	Dimensions (mm)	Min. order quantity	Pack quantity	Article Number	EAN Code
PACKOUT [™] compact slim organiser	250 x 380 x 65	1	1	4932471065	4058546286934

PACKOUT™ compact tool box

- Quick-Adjust Dividers allow users to store and organize larger equipment and accessories, such as fittings, connectors or caulk.
- Enough storage capacity to fit power tools like circular saws, grinders, drill drivers.
- 34 kg weight capacity.
- Constructed with impact resistant polymers for jobsite durability.
- IP 65 rated weather seal to keep out rain and jobsite debris.
- Part of the PACKOUT™ modular storage system.



Description	Dimensions (mm)	Pack quantity	Min. order quantity	Article Number	EAN Code
PACKOUT™ compact tool box	411 x 254 x 330	1	1	4932471723	4058546292232



PACKOUT™ hard cooler

- Double premium insulation keeps contents cold for up to 30 hours.
- IP 65 Food Grade Leak-Proof Liner prevents leakages and protects contents from debris and dust.
- Integrated bottle opener.
- Removable tray for separate storage of personal items to keep them elevated above icy water.
- 15 l capacity.
- Constructed with impact resistant polymers for jobsite durability.
- Part of the PACKOUT™ modular storage system.



Description	Dimensions (mm)	Pack quantity	Min. order quantity	Article Number	EAN Code
PACKOUT™ hard cooler	411 x 254 x 330	1	1	4932471722	4058546296216



PACKOUT™ 2 wheeled cart

NEW

- 2 integrated PACKOUT™ mounting locations for additional storage options.
- Integrated holder for longer tools, such as levels.
- 180 kg weight capacity.
- 25 cm in-board wheels easily roll through doorways.
- Folding base plate for easy storage.
- Part of the PACKOUT™ modular storage system.
- Constructed with impact resistant polymers for jobsite durability.



Description	Dimensions (mm)	Pack quantity	Min. order quantity	Article Number	EAN Code
PACKOUT™ 2 wheeled cart	1200 x 510 x 290	1	1	4932472131	4058546325275



PACKOUT™ flat trolley

- 113kg weight capacity.
- Durable casters to easily roll with heavy load on a jobsite.
- Includes 1 locking brake and 2 side locks to stop the trolley and easily connect the PACKOUT™ boxes and bags.
- Part of the PACKOUT™ modular storage system.



Description	Dimensions (mm)	Pack quantity	Min. order quantity	Article Number	EAN Code
PACKOUT™ flat trolley	610 x 480 x 190	1	1	4932471068	4058546286965

PACKOUT™ crate

- Versatile stacking options: vertical and horizontal.
- 22 kg weight capacity.
- Large storage capacity for all kind of tools.
- Other PACKOUT™ products can be stacked on top of the crate.
- Part of the PACKOUT™ modular storage system.



Description	Dimensions (mm)	Pack quantity	Min. order quantity	Article Number	EAN Code
PACKOUT™ crate	450 x 390 x 250	1	1	4932471724	4058546296230

PACKOUT™ mounting plate

- Multiple mounting configurations.
- Turn the PACKOUT™ into a stationary storage.
- 4 5kg floor mounted weight capacity.
- 22 kg wall mounted weight capacity.
- Connects to all MILWAUKEE® PACKOUT™ modular storage.
- Impact resistant polymer construction.



Description	Dimensions (mm)	Pack quantity	Min. order quantity	Article Number	EAN Code
PACKOUT™ mounting plate	600 x 470 x 030	1	6	4932471638	4058546295370

PACKOUT™ customisable work surface

NEW

- Marine grade plywood top provides smooth surface for light assembly work, writing, sketching or working on a laptop.
- Fastener-ready surface allows for easy mounting of common jobsite materials and larger tools on top of a PACKOUT™ stack.
- 22 kg weight capacity.
- Part of the PACKOUT™ modular storage system.
- Constructed with impact resistant polymers for jobsite durability.



Description	Dimensions (mm)	Pack quantity	Min. order quantity	Article Number	EAN Code
PACKOUT™ customisable work surface	60 x 650 x 380	1	6	4932472128	4058546325244



PACKOUT™ tote toolbag

- Part of the PACKOUT™ modular storage system.
- 1680 ballistic material construction.
- Impact resistant molded base.
- All metal hardware.
- Durable overmolded handle.



Description	Dimensions (mm)	No. of pockets	Pack quantity	Min. order quantity	Article Number	EAN Code
① 25 cm tote toolbag	250 x 280 x 320	28	1	1	4932464084	4058546220297
② 40 cm tote toolbag	250 x 400 x 320	31	1	1	4932464085	4058546220303
③ 50 cm tote toolbag	250 x 500 x 320	32	1	1	4932464086	4058546220310



PACKOUT™ duffel bag

- Part of the PACKOUT™ modular storage system.
- Made from 1680D Ballistic Material for jobsite durability.
- Impact resistant polymer base protects contents from water, dirt and tear.
- Large storage capacity for larger tools.



Description	Pack quantity	Min. order quantity	Article Number	EAN Code
① 38 cm PACKOUT™ duffel bag	1	1	4932471066	4058546286941
② 50 cm PACKOUT™ duffel bag	1	1	4932471067	4058546286958



PACKOUT™ tech bag

- Part of the PACKOUT™ modular storage system.
- Made from 1680D ballistic material for jobsite durability.
- 58 total pockets. Hardshell protected instrument pocket.
- Secure and protected storage for laptops and tablets.
- Impact resistant polymer base protects contents from water, dirt and tear.



Description	Pack quantity	Min. order quantity	Article Number	EAN Code
PACKOUT™ tech bag	1	1	4932471130	4058546287580

PACKOUT™ backpack

- Part of the PACKOUT™ modular storage system.
- Made from 1680D ballistic material for jobsite durability.
- 48 total pockets including a hard-shell protected instrument pocket.
- Extra back padding, chest strap, attachment strap for rolling bags and heavy duty harness for ultimate jobsite comfort.
- Impact resistant polymer base protects contents from water and dirt and also allows backpack to stand up.



Description	Pack quantity	Min. order quantity	Article Number	EAN Code
PACKOUT™ backpack	1	1	4932471131	4058546287597

PACKOUT™ jobsite cooler

- Part of the PACKOUT™ modular storage system.
- 20l volume capacity with a dry compartment and a storage space for drinks.
- Extra insulation keeps contents cold for 24 hours.
- Impact resistant polymer base protects contents from water, dirt, and tear.
- Shoulder strap for easy transport.



Description	Pack quantity	Min. order quantity	Article Number	EAN Code
PACKOUT™ jobsite cooler	1	1	4932471132	4058546287603

PACKOUT[™] foam inserts

- Fully customisable - foam Insert allows you to fully customise your storage by cutting out custom pockets to securely store and protect your tools.
- Durable construction provides increased protection for tools.
- Optimised storage - allows easy access to the tools.
- Ref. 4932471428: Designed to fit in two PACKOUT[™] boxes - tool box (4932464080) & large tool box (4932464079).
- Ref. 4932464078: Designed to fit in the PACKOUT[™] trolley box (4932464078).



Description	Pack quantity	Min. order quantity	Article Number	EAN Code
PACKOUT [™] foam insert	2	1	4932471428	4058546290566
PACKOUT [™] trolley foam insert	1	1	4932471927	4058546298265



PACKOUT[™] adaptor HD box

Description	Pack quantity	Min. order quantity	Article Number	EAN Code
PACKOUT [™] adaptor HD box	1	1	4932464081	4058546220266



PACKOUT[™] inserts

- Removable inserts for PACKOUT[™] boxes and organisers.
- Ref. 4932478298: Organisation tray designed to fit PACKOUT[™] trolley box (4932464078) and large box (4932464079).
- Ref. 4932478299: Set of organisation trays designed to fit PACKOUT[™] box (4932464080).
- Ref. 4932478300: Set of organisation boxes designed to fit PACKOUT[™] organiser (4932464082) and compact organiser (4932464083).
- Ref. 4932478301: Set of organisation boxes designed to fit PACKOUT[™] slim organiser (4932471064) and compact slim organiser (4932471065).

Description	Pack quantity	Min. order quantity	Article Number	EAN Code
① Removable tray for PACKOUT [™] trolley box and large box	1	1	4932478298	4058546344757
② Removable trays for PACKOUT [™] box	4	1	4932478299	4058546344764
③ Removable bins for PACKOUT [™] slim organiser and compact slim organiser	5	1	4932478301	4058546344788
④ Removable bins for PACKOUT [™] organiser and compact organiser	5	1	4932478300	4058546344771



Ultimate jobsite backpack

- Constructed with 1680D ballistic material and with rugged metal zippers to provide increased durability.
- Hard molded base allows backpack to stand up and reduces ingress of dirt and water.
- Adjustable chest strap and attachment strap for rolling bags.
- Padded and breathable load-bearing harness evenly distributes the weight for more comfort and jobsite performance.
- 48 total pockets including 2 hardshell pockets to protect electronics and equipment from impact.
- Backpack provides exceptional organisation.



Description	Pack quantity	Min. order quantity	Article Number	EAN Code
Ultimate jobsite backpack	1	1	4932464833	4058546227784



Jobsite backpack

- Durable construction, made from 1680D ballistic nylon.
- Hard moulded base allows bag to stand-up and provides ultimate all-weather protection.
- Padded, breathable straps for ultimate comfort and jobsite performance.
- Large storage - 35 pockets in total.
- Fold down front pocket for easier access and storage of larger items. Side water bottle pocket.
- Vertical tool wall maximises storage space while allowing for bulk storage space.
- Laptop pocket allows protected storage for laptops/tablets and personal goods.
- Exterior daisy chains allow clip on storage.



Description	Pack quantity	Min. order quantity	Article Number	EAN Code
Jobsite backpack	1	1	48228200	045242333943



Tradesman backpack

- Durable construction, made from 1680D ballistic nylon.
- Padded straps for more comfort and jobsite performance.
- Laptop pocket allows protected storage for laptops/tablets and personal goods.
- 18 organiser pockets allow variety of options.



Description	Pack quantity	Min. order quantity	Article Number	EAN Code
Tradesman backpack	1	1	4932464252	4058546221973

Low profile backpack

- Constructed with 1680D ballistic material and with rugged metal zippers to provide increased durability.
- Reinforced base protects the backpack from being damaged by abusive jobsite conditions.
- Adjustable chest strap and attachment strap for rolling bags.
- Padded and breathable load-bearing harness evenly distributes the weight for more comfort and jobsite performance.
- 22 pockets including a padded electronic sleeve to provide ultimate organisation.



Description	Pack quantity	Min. order quantity	Article Number	EAN Code
Low profile backpack	1	1	4932464834	4058546227791

Jobsite cooler

- Constructed with 1680D ballistic material and with rugged metal zippers to provide increased durability.
- Specifically designed to be durable enough to withstand tough jobsite conditions.
- Cooler utilises double insulation and a food-grade leak proof liner to keep ice cold for 24 hours without leaking.
- Tape measure clip with a bottle opener provides ultimate versatility.
- Padded shoulder strap with metal hardware for ultimate durability.
- Tech pocket and dry storage compartment for storing tablets and electronic devices.



Description	Pack quantity	Min. order quantity	Article Number	EAN Code
Jobsite cooler	1	1	4932464835	4058546227807

Electricians pouch

- Robust construction, made from 1680D ballistic nylon.
- Double stitched with stronger riveted seams.
- Integrated handle allows easy transport and provides an easy mounting point on common jobsite materials.
- Solid base allows bag to stand-up, even when fully loaded.
- Integrated belt loops allow bag to be worn on a tool belt.
- Center mounted metal D-rings allow bag to hang evenly from shoulder strap.
- Metal tape measure clip securely stores tape for easy access.



Description	Pack quantity	Min. order quantity	Article Number	EAN Code
Electricians pouch	1	1	48228112	045242509157

Contractor rig

- Robust construction, made from 1680D ballistic nylon.
- Double stitched with stronger riveted seams.
- Padded 4-point harness distributes weight for all day comfort.
- Padded, breathable belt for ultimate comfort and jobsite performance.
- Integrated handle allows easy transport of the pouch and provides easy mounting point on common jobsite materials.
- Metal suspender attachments allow suspenders to be added.



Description	Pack quantity	Min. order quantity	Article Number	EAN Code
Contractor rig	1	1	48228120	045242333974

Padded rig

- Adjustable straps designed to fit all users.
- 1680D ballistic material construction.



Description	Pack quantity	Min. order quantity	Article Number	EAN Code
Padded rig	1	1	48228145	045242358212

Work belt

- Metal hardware and 1680D ballistic nylon provide a lifetime of service.
- Up to 152 mm (6") of padding and can accommodate waist sizes up to 143 mm (53").



Description	Pack quantity	Min. order quantity	Article Number	EAN Code
Work belt	1	1	48228140	045242358168

Transport cases

Description		Metal/ Plastic	Pack quantity	Min. order quantity	Article Number	EAN Code
Transport case for hammers	K 900,K 950	Plastic case	1	1	4931375502	4002395752881
Transport case for wall chasers	WCE 30,WCS 45, DME 30,DME 45	MFE 1500, MFE 1305,MF 1900	Metal case	1	4932383357	4002395357390

HEAVY DUTY™ boxes

■ Cases supplied with latches and foam.

HD Box Size	Dimensions (mm)	Pack quantity	Min. order quantity	Article Number	EAN Code
1	475 x 358 x 132	1	1	4932453385	4002395146376
3	475 x 358 x 230	1	1	4932453386	4002395143634
Accessories HD Box organisers		1	1	4932451545	4002395146581
HD Box 1 universal - supplied with foam insert		1	1	4932459751	4058546029234
HD Box 1 universal - with FUEL logo - supplied with foam insert		1	1	4932459206	4002395287215
Spare latches		2	1	4932373252	4002395347247
PACKOUT™ adaptor HD box		1	1	4932464081	4058546220266



Inserts for HEAVY DUTY™ boxes

HD Box Insert	Pack quantity	Min. order quantity	Article Number	EAN Code
1	1	1	4932440936	4002395147588
3	1	1	4932453379	4002395148202
8	1	1	4932453508	4002395146390
9	1	1	4932453507	4002395143603
10	1	1	4932453509	4002395143610
11	1	1	4932453510	4002395143627
12	1	1	4932453859	4002395275649
13	1	1	4932453855	4002395275656
14	1	1	4932453856	4002395275663
15	1	1	4932453857	4002395275670
16	1	1	4932453858	4002395275687
17	1	1	4932453860	4002395275694
HD Box accessories insert	1	1	4932451546	4002395146598



HD Box Insert	HD Box Size	Fits MILWAUKEE® kits	Article Number	EAN Code
1	1	M18 CDD-202X, M18 CPD-202X, M18 CDD-502X, M18 CPD-502X, M18 CIW12-502X, M18 CID-202X, M18 CID-502X	4932440936	4002395147588
3	1	M18 FDD-202X, M18 FDD-502X, M18 FPD-202X, M18 FPD-502X, M18 ONEPD-502X, M18 ONEDD-502X	4932453379	4002395148202
8	1	M18 CHIWF12-502X, M18 CHIWF34-502X, M18 CHIWP12-502X	4932453508	4002395146390
9	1	M18 CAG115X-502X, M18 CAG125X-502X, M18 CAG125XPD-502X	4932453507	4002395143603
10	1	M18 CRAD-502X	4932453509	4002395143610
11	1	M18 FIWF12-502X, M18 FID-502X, M18 ONEID-502X, M18 ONEIW-502X, M18 ONEIW-502X	4932453510	4002395143627
12	3	M18 CCS66-502X	4932453859	4002395275649
13	3	M18 CHX-502X	4932453855	4002395275656
14	3	M18 CHPX-502X	4932453856	4002395275663
15	3	M18 CSX-502X	4932453857	4002395275670
16	3	M18 CCS55-502X	4932453858	4002395275687
17	3	M18 CAG125XPDB-502X, M18 CAG115XPDB-502X	4932453860	4002395275694
HD Box accessories insert			4932451546	4002395146598

ACCESSORIES & HAND TOOLS MERCHANDISING SOLUTIONS

WHATEVER THE SPACE. WE HAVE THE SOLUTION...

MILWAUKEE® offers a comprehensive range of merchandising systems to ensure optimum display of our accessories and hand tools in store.



TiD-extra
Industrial Technologies d.o.o.



DISPLAY:
**MINIBOX
LEVEL**

Article number:
4932459100



DISPLAY:
**SDS-PLUS
MX4 DRILL
BIT SET (7PC)**

Article number:
4932478674



DISPLAY:
**INKZALL™
LIQUID PAINT
MARKER - WHITE**

Article number:
48223711



DISPLAY:
**SHOCKWAVE™
IMPACT DUTY TORX
BIT SET (32 PC)**

Article number:
4932471586

**COUNTER DISPLAYS OFFER A FLEXIBLE SOLUTION AT POINT OF PURCHASE,
OR CAN BE PLACED ON THE BASE SHELVES OF THE WALL UNITS.**



DISPLAY:
1M PEG WALLBAY*

Article number:
4939434488

- Header with backlit MILWAUKEE® log with 3 downlighters and kick plate.
- Great for use in conjunction with MILWAUKEE® 1m rows and red racks, for a merchandising solution that is easy to implement straight from delivery.
- Height 223cm & depth 57cm.



DISPLAY:
LOW LEVEL GONDOLA*

Article number:
4939434491

- Small header with MILWAUKEE® vinyl logo.
- Great for use in conjunction with MILWAUKEE® 1m rows and red racks.
- Height 150cm & depth 58cm.



DISPLAY:
MILWAUKEE® HEX BIN*

Article number:
4939435277

- Branded hexagonal cardboard bin ideal for display of handheld accessories.
- Height 110cm & width 50cm.



DISPLAY:
TAPE MEASURE TOWER*

Article number:
4939435226

- Height 191cm, width 70cm & depth 43cm.



DISPLAY:
LEVEL CAROUSEL*

TOP Article number:
493963870 BOTTOM Article number:
4939638800

- Must order both parts for complete carousel.
- Height 224cm, width 65cm & depth 65cm



DISPLAY:
MX4 ACCESSORIES COUNTER DISPLAY*

Article number:
4939694400

- Height 55cm, width 45cm & depth 29cm

WHEN YOU BUY A MILWAUKEE® 1 M ROW, YOU RECEIVE:

1.

A PREMIUM SELECTION OF BEST-SELLING MILWAUKEE® HAND TOOLS

2.

A MERCHANDISING BAR THAT CAN BE HUNG ON A STANDARD MILWAUKEE® 1 M WALL BAY

3.

THE RIGHT AMOUNT OF HOOKS TO DISPLAY ALL ORDERED PRODUCTS

4.

REORDER TAGS WITH PART NUMBERS OF EACH PRODUCT TO FACILITATE STOCK REORDERING

5.

ALL CONTENTS PRE-MERCHANDISED AND PACKED IN ONE CARTON – READY TO BE PUT ON THE WALL BAY STRAIGHT OUT OF THE BOX!



Knives - 1 metre row

Pos	Description	Quantity	Article Number	EAN Code
1	Snap knife 9 mm	5	48221960	045242296811
2	Snap blades 9 mm	5	48229109	045242288649
3	Snap knife 18 mm	5	48221961	045242296798
4	Snap blades 18 mm	5	48229118	045242288656
5	Snap knife 25 mm	5	48221962	045242296828
6	Snap blades 25 mm	5	48229125	045242288663
7	FASTBACK™ compact flip utility knife	5	4932471356	4058546289843
8	FASTBACK™ flip utility knife with blade storage	5	4932471358	4058546289867
9	Sliding utility knife	5	4932471359	4058546289874
10	General purpose utility knife blades	5	48221905	045242268061
11	FASTBACK™ folding knife	5	48221990	045242296842
12	HARDLINE™ folding knife - smooth	5	48221994	045242477043

Pos	Display Material	Quantity	Article Number	EAN Code
1	MILWAUKEE® Red 1m Short Accessories Display Bar	1	4939434656	4002395557967
2	MILWAUKEE® Red 105mm Accessory Bar Euro Hook	12	4939434650	4002395557905
3	MILWAUKEE® Universal Accessories Strip	1	4939510100	4002395186433
4	Carton	1	4931373861	4002395734399
5	Re-Order Tags	1	4939435455	4058546307462

4932 478475
4058546 346669



Snips, saws and scissors - 1 metre row

Pos	Description	Quantity	Article Number	EAN Code
1	Folding jab saw	4	48220305	045242204618
2	Compact hacksaw	4	48220012	045242204571
3	Rasping jab saw	4	48229304	045242480555
4	Straight scissors	4	48224044	045242347483
5	Offset scissors	4	48224043	045242347476
6	Metal snips straight	4	48224530	045242503643
7	Metal snips right	4	48224520	045242503636
8	Metal snips left	4	48224510	045242503629
9	Cable cutter	4	48226104	045242356140

Pos	Display Material	Quantity	Article Number	EAN Code
1	MILWAUKEE® Red 1m Short Accessories Display Bar	1	4939434656	4002395557967
2	MILWAUKEE® Red 105mm Accessory Bar Euro Hook	9	4939434650	4002395557905
3	MILWAUKEE® Universal Accessories Strip	1	4939510100	4002395186433
4	Carton	1	4931373861	4002395734399
5	Re-Order Tags	1	4939435456	4058546307479

4932 478476
4058546 346676



Cutting starter set - 1 metre row

Pos	Description	Quantity	Article Number	EAN Code
1	Folding jab saw	4	48220305	045242204618
2	Rasping jab saw	4	48229304	045242480555
3	Offset scissors	4	48224043	045242347476
4	Metal snips straight	4	48224530	045242503643
5	Metal snips right	4	48224520	045242503636
6	Metal snips left	4	48224510	045242503629
7	Snap knife 18 mm	4	48221961	045242296798
8	Snap blades 18 mm	4	48229118	045242288656
9	FASTBACK™ flip utility knife with blade storage	4	4932471358	4058546289867
10	General purpose utility knife blades	4	48221905	045242268061
11	FASTBACK™ folding knife	4	48221990	045242296842

4932 478477
4058546 346683



Pos	Display material	Quantity	Article Number	EAN Code
1	MILWAUKEE® Red 1m Short Accessories Display Bar	1	4939434656	4002395557967
2	MILWAUKEE® Red 105mm Accessory Bar Euro Hook	11	4939434650	4002395557905
3	MILWAUKEE® Universal Accessories Strip	1	4939510100	4002395186433
4	Carton	1	4931373861	4002395734399
5	Re-Order Tags	1	4939435457	4058546307486

Premium gloves - 1 metre row

Pos	Description	Quantity	Article Number	EAN Code
1	Demolition Gloves - M/8 - 1pc	2	48229731	045242479436
2	Demolition Gloves - L/9 - 1pc	2	48229732	045242479443
3	Demolition Gloves - XL/10 - 1pc	2	48229733	045242479450
4	Demolition Gloves - XXL/11 - 1pc	2	48229734	045242479467
5	Hybrid Leather Gloves - M/8 - 1pc	2	4932471912	4058546298111
6	Hybrid Leather Gloves - L/9 - 1pc	2	4932471913	4058546298128
7	Hybrid Leather Gloves - XL/10 - 1pc	2	4932471914	4058546298135
8	Hybrid Leather Gloves - XXL/11 - 1pc	2	4932471915	4058546298142
9	Leather Gloves - 8/M - 1pc	2	4932478123	4058546340568
10	Leather Gloves - 9/L - 1pc	2	4932478124	4058546340575
11	Leather Gloves - 10/XL - 1pc	2	4932478125	4058546340582
12	Leather Gloves - 11/XXL - 1pc	2	4932478126	4058546340599
13	Impact Demolition Gloves - M/8 - 1pc	2	4932471908	4058546298074
14	Impact Demolition Gloves - L/9 - 1pc	2	4932471909	4058546298081
15	Impact Demolition Gloves - XL/10 - 1pc	2	4932471910	4058546298098
16	Impact Demolition Gloves - XXL/11 - 1pc	2	4932471911	4058546298104

4932 478479
4058546 346720



Pos	Display Material	Quantity	Article Number	EAN Code
1	MILWAUKEE® Red 1m Short Accessories Display Bar	1	4939434656	4002395557967
2	MILWAUKEE® Red 105mm Accessory Bar Euro Hook	8	4939434650	4002395557905
3	MILWAUKEE® Universal Accessories Strip	1	4939510100	4002395186433
4	Carton	1	4931373861	4002395734399
5	Re-Order Tags	1	4939435459	4058546307509

 **STAY SAFE.
STAY PRODUCTIVE.**

Cut resistant gloves - 1 metre row

4932 478478
4058546 346690



Pos	Description	Quantity	Article Number	EAN Code
1	Cut Level 1 Dipped Gloves - M/8 - 1pc	2	4932471416	4058546290443
2	Cut Level 1 Dipped Gloves - L/9 - 1pc	6	4932471417	4058546290450
3	Cut Level 1 Dipped Gloves - XL/10 - 1pc	6	4932471418	4058546290467
4	Cut Level 1 Dipped Gloves - XXL/11 - 1pc	2	4932471419	4058546290474
5	Cut Level 3 Dipped Gloves - M/8 - 1pc	2	4932471420	4058546290481
6	Cut Level 3 Dipped Gloves - L/9 - 1pc	6	4932471421	4058546290498
7	Cut Level 3 Dipped Gloves - XL/10 - 1pc	6	4932471422	4058546290504
8	Cut Level 3 Dipped Gloves - XXL/11 - 1pc	2	4932471423	4058546290511
9	Cut Level 5 Dipped Gloves - M/8 - 1pc	2	4932471424	4058546290528
10	Cut Level 5 Dipped Gloves - L/9 - 1pc	6	4932471425	4058546290535
11	Cut Level 5 Dipped Gloves - XL/10 - 1pc	6	4932471426	4058546290542
12	Cut Level 5 Dipped Gloves - XXL/11 - 1pc	2	4932471427	4058546290559
13	Hi-Vis Cut Level 3 Dipped Gloves - M/8 - 1pc	1	4932478131	4058546340643
14	Hi-Vis Cut Level 3 Dipped Gloves - L/9 - 1pc	3	4932478132	4058546340650
15	Hi Vis Cut Level 3 Dipped Gloves - XL/10 - 1pc	3	4932478133	4058546340667
16	Hi-Vis Cut Level 3 Dipped Gloves -11/XXL - 1pc	1	4932478134	4058546340674
17	Impact Cut Level 3 Dipped Gloves - 8/M - 1pc	1	4932478127	4058546340605
18	Impact Cut Level 3 Dipped Gloves - 9/L - 1pc	2	4932478128	4058546340612
19	Impact Cut Level 3 Dipped Gloves - 10/XL - 1pc	2	4932478129	4058546340629
20	Impact Cut Level 3 Dipped Gloves - 11/XXL - 1pc	1	4932478130	4058546340636

Pos	Display Material	Quantity	Article Number	EAN Code
1	MILWAUKEE® Red 1m Medium Accessories Display Bar	1	4939434655	4002395557950
2	MILWAUKEE® Red 210mm Accessory Bar Euro Hook	8	4939434651	4002395557912
3	MILWAUKEE® Universal Accessories Strip	1	4939510100	4002395186433
4	Carton	1	4931373861	4002395734399
5	Re-Order Tags	1	4939435458	4058546307493



Gloves starter set - 1 metre row

4932 478480
4058546 346737



Pos	Description	Quantity	Article Number	EAN Code
1	Cut Level 1 Dipped Gloves - M/8 - 1pc	2	4932471416	4058546290443
2	Cut Level 1 Dipped Gloves - L/9 - 1pc	4	4932471417	4058546290450
3	Cut Level 1 Dipped Gloves - XL/10 - 1pc	4	4932471418	4058546290467
4	Cut Level 1 Dipped Gloves - XXL/11 - 1pc	2	4932471419	4058546290474
5	Cut Level 3 Dipped Gloves - M/8 - 1pc	1	4932471420	4058546290481
6	Cut Level 3 Dipped Gloves - L/9 - 1pc	2	4932471421	4058546290498
7	Cut Level 3 Dipped Gloves - XL/10 - 1pc	2	4932471422	4058546290504
8	Cut Level 3 Dipped Gloves - XXL/11 - 1pc	1	4932471423	4058546290511
9	Cut Level 5 Dipped Gloves - M/8 - 1pc	1	4932471424	4058546290528
10	Cut Level 5 Dipped Gloves - L/9 - 1pc	2	4932471425	4058546290535
11	Cut Level 5 Dipped Gloves - XL/10 - 1pc	2	4932471426	4058546290542
12	Cut Level 5 Dipped Gloves - XXL/11 - 1pc	2	4932471427	4058546290559
13	Demolition Gloves - M/8 - 1pc	2	48229731	045242479436
14	Demolition Gloves - L/9 - 1pc	3	48229732	045242479443
15	Demolition Gloves - XL/10 - 1pc	3	48229733	045242479450
16	Demolition Gloves - XXL/11 - 1pc	2	48229734	045242479467
17	FREE-FLEX Gloves - M/8 - 1pc	1	48229711	045242508693
18	FREE-FLEX Gloves - L/9 - 1pc	2	48229712	045242508709
19	FREE-FLEX Gloves - XL/10 - 1pc	2	48229713	045242508716
20	FREE-FLEX Gloves - XXL/11 - 1pc	1	48229714	045242508723
21	Leather Gloves - 8/M - 1pc	1	4932478123	4058546340568
22	Leather Gloves - 9/L - 1pc	2	4932478124	4058546340575
23	Leather Gloves - 10/XL - 1pc	2	4932478125	4058546340582
24	Leather Gloves - 11/XXL - 1pc	1	4932478126	4058546340599

Pos	Display Material	Quantity	Article Number	EAN Code
1	MILWAUKEE® Red 1m Medium Accessories Display Bar	1	4939434655	4002395557950
2	MILWAUKEE® Red 210mm Accessory Bar Euro Hook	8	4939434651	4002395557912
3	MILWAUKEE® Universal Accessories Strip	1	4939510100	4002395186433
4	Carton	1	4931373861	4002395734399
5	Re-Order Tags	1	4939435460	4058546307516



Tri-lobe screwdrivers - 1 metre row

4932 472208
4058546 326043



Pos	Description	Quantity	Article Number	EAN Code
1	SL 0.4 x 2 x 65	5	4932471773	4058546296728
2	SL 0.4 x 2.5 x 75	5	4932471774	4058546296735
3	SL 0.5 x 3 x 75	5	4932471775	4058546296742
4	SL 0.5 x 3 x 150	5	4932471776	4058546296759
5	SL 0.6 x 3.5 x 100	5	4932471777	4058546296766
6	SL 0.8 x 4 x 100	5	4932471778	4058546296773
7	SL 1.0 x 5.5 x 125	5	4932471779	4058546296780
8	SL 1.2 x 6.5 x 125	5	4932471781	4058546296803
9	SL 1.6 x 8 x 175	5	4932471783	4058546296827
10	SL 1.2 x 10 x 200	5	4932471784	4058546296834
11	PH0 x 75	5	4932471785	4058546296841
12	PH1 x 100	5	4932471786	4058546296858
13	PH2 x 45	5	4932471787	4058546296865
14	PH2 x 125	5	4932471788	4058546296872
15	PH3 x 150	5	4932471789	4058546296889
16	PZ0 x 75	5	4932471790	4058546296896
17	PZ1 x 100	5	4932471791	4058546296902
18	PZ2 x 45	5	4932471792	4058546296919
19	PZ2 x 125	5	4932471793	4058546296926
20	PZ3 x 150	5	4932471794	4058546296933

Pos	Display Material	Quantity	Article Number	EAN Code
1	MILWAUKEE® Red 1m Short Accessories Display Bar	1	4939434656	4002395557967
2	MILWAUKEE® Red 210mm Accessory Bar Single Prong Hook	20	4939434653	4002395557936
3	MILWAUKEE® Universal Accessories Strip	1	4939510100	4002395186433
4	Carton	1	4931373861	4002395734399
5	Re-Order Tags	1	4939704900	4058546306441

Safety glasses - 1 metre row

Pos	Description	Quantity	Article Number	EAN Code
1	Safety glasses clear	6	4932471881	4058546297800
2	Safety glasses tinted	3	4932471882	4058546297817
3	Performance safety glasses clear	6	4932471883	4058546297824
4	Performance safety glasses tinted	6	4932471884	4058546297831
5	Premium safety glasses clear	3	4932471885	4058546297848
6	Premium safety glasses polarised	3	4932471886	4058546297855

Pos	Display Material	Quantity	Article Number	EAN Code
1	MILWAUKEE® Red 1m Short Accessories Display Bar	1	4939434656	4002395557967
2	MILWAUKEE® Red 105mm Accessory Bar Euro Hook	9	4939434650	4002395557905
3	MILWAUKEE® Universal Accessories Strip	1	4939510100	4002395186433
4	Carton	1	4931373861	4002395734399
5	Re-Order Tags	1	4939435461	4058546307523

4932 478481
4058546 346744



Tape measures - 1 metre row

Pos	Description	Quantity	Article Number	EAN Code
1	Tape measure pro compact C5/19	4	4932459592	4058546027643
2	Tape measure pro compact C8/25	4	4932459594	4058546027667
3	Magnetic Tape Measure 5 m	4	4932464599	4058546225445
4	Magnetic Tape Measure 8 m	4	4932464600	4058546225452
5	Magnetic Tape Measure 10 m	4	4932464601	4058546225469
6	Premium Wide Blade 5 m	4	4932471815	4058546297145
7	Premium Wide Blade 8 m	4	4932471816	4058546297152
8	STUD Gen2 5 m	4	4932471626	4058546295257
9	STUD Gen2 8 m	4	4932471627	4058546295264

Pos	Display Material	Quantity	Article Number	EAN Code
1	MILWAUKEE® Red 1m Medium Accessories Display Bar	1	4939434655	4002395557950
2	MILWAUKEE® Red 210mm Accessory Bar Euro Hook	9	4939434651	4002395557912
3	MILWAUKEE® Universal Accessories Strip	1	4939510100	4002395186433
4	Carton	1	4931373861	4002395734399
5	Re-Order Tags	1	4939435462	4058546307530

4932 478482
4058546 346751



Gripping and fastening - 1 metre row

Pos	Description	Quantity	Article Number	EAN Code
1	10" TORQUE LOCK™ curved jaw	4	4932471725	4058546296247
2	11" hand clamps with swivel pads	4	4932471727	4058546296261
3	Water pump pliers 300 mm	5	48226212	045242342259
4	Water pump pliers 250 mm	5	48226210	045242342242
5	10" adjustable wrench.	5	48227410	045242356201
6	6" adjustable wrench.	5	48227406	045242356225
7	9 in 1 ratchet multi-bit screwdriver - universal	4	4932471598	4058546294977
8	8 in 1 compact ratchet multi-bit screwdriver	4	4932471868	4058546297671

Pos	Display Material	Quantity	Article Number	EAN Code
1	MILWAUKEE® Red 1m Short Accessories Display Bar	1	4939434656	4002395557967
2	MILWAUKEE® Red 105mm Accessory Bar Euro Hook	8	4939434650	4002395557905
3	MILWAUKEE® Universal Accessories Strip	1	4939510100	4002395186433
4	Carton	1	4931373861	4002395734399
5	Re-Order Tags	1	4939435463	4058546307547

4932 478483
4058546 346768



VDE screwdrivers - 1 metre row

Pos	Description	Quantity	Article Number	EAN Code
1	SL 0.5 x 3 x 100	5	4932471445	4058546290733
2	SL 0.8 x 4 x 100	5	4932471446	4058546290740
3	SL 1.0 x 5.5 x 125	5	4932471447	4058546290757
4	PH1 x 80	5	4932471448	4058546290764
5	PH2 x 100	5	4932471449	4058546290771
6	PZ1 x 80	5	4932471450	4058546290788
7	PZ2 x 100	5	4932471451	4058546290795
8	VDE slim screwdriver set (5pc)	2	4932471452	4058546290801
9	VDE slim screwdriver set (7pc)	2	4932471453	4058546290818

Pos	Quantity	Article Number	EAN Code	
1	MILWAUKEE® Red 1m Short Accessories Display Bar	1	4939434656	4002395557967
2	MILWAUKEE® Red 105mm Accessory Bar Euro Hook	9	4939434650	4002395557905
3	MILWAUKEE® Universal Accessories Strip	1	4939510100	4002395186433
4	Carton	1	4931373861	4002395734399
5	Re-Order Tags	1	4939435464	4058546307554

4932 478484
4058546 346775



VDE pliers - 1 metre row

Pos	Description	Quantity	Article Number	EAN Code
1	VDE combination plier	4	4932464571	4058546225162
2	VDE combination plier	4	4932464572	4058546225179
3	VDE diagonal cutter	4	4932464566	4058546225117
4	VDE diagonal cutter	4	4932464567	4058546225124
5	VDE diagonal cutter	4	4932464568	4058546225131
6	VDE heavy duty diagonal cutter	4	4932464569	4058546225148
7	VDE heavy duty diagonal cutter	4	4932464570	4058546225155
8	VDE long round nose plier	4	4932464564	4058546225094
9	VDE long 45 deg. round nose pliers	4	4932464565	4058546225100
10	VDE cable cutter	4	4932464562	4058546225070
11	VDE cable cutter	4	4932464563	4058546225087
12	VDE wire stripping plier	4	4932464573	4058546225186
13	VDE water pump plier	4	4932464574	4058546225193

Pos	Display Material	Quantity	Article Number	EAN Code
1	MILWAUKEE® Red 1m Short Accessories Display Bar	1	4939434656	4002395557967
2	MILWAUKEE® Red 105mm Accessory Bar Euro Hook	13	4939434650	4002395557905
3	MILWAUKEE® Universal Accessories Strip	1	4939510100	4002395186433
4	Carton	1	4931373861	4002395734399
5	Re-Order Tags	1	4939435465	4058546307561

4932 478485
4058546 346782

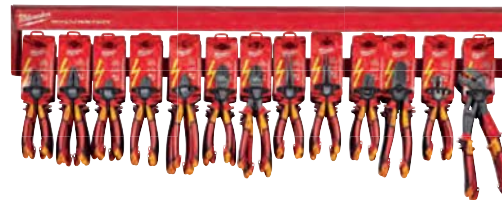

VDE starter set - 1 metre row

Pos	Description	Quantity	Article Number	EAN Code
1	VDE combination plier	4	4932464571	4058546225162
2	VDE combination plier	4	4932464572	4058546225179
3	VDE diagonal cutter	4	4932464566	4058546225117
4	VDE diagonal cutter	4	4932464567	4058546225124
5	VDE cable cutter	4	4932464562	4058546225070
6	VDE long round nose plier	4	4932464564	4058546225094
7	VDE wire stripping plier	4	4932464573	4058546225186
8	VDE water pump plier	4	4932464574	4058546225193
9	VDE Screwdriver set 1 (7pc)	2	4932464067	4058546220129
10	VDE slim screwdriver set (7pc)	2	4932471453	4058546290818

Pos	Display Material	Quantity	Article Number	EAN Code
1	MILWAUKEE® Red 1m Short Accessories Display Bar	1	4939434656	4002395557967
2	MILWAUKEE® Red 105mm Accessory Bar Euro Hook	10	4939434650	4002395557905
3	MILWAUKEE® Universal Accessories Strip	1	4939510100	4002395186433
4	Carton	1	4931373861	4002395734399
5	Re-Order Tags	1	4939435466	4058546307578

4932 478486
4058546 346799



HVAC cutting tools - 1 metre row

Pos	Description	Quantity	Article Number	EAN Code
1	Mini copper tubing cutter 15 mm	4	48229250	045242521210
2	Mini copper tubing cutter 22 mm	4	48229258	045242521258
3	Mini copper tubing cutter 28 mm	4	48229251	045242521227
4	Tubing cutter blades for copper	6	48224256	045242356256
5	Constant swing copper tubing cutter 28 mm	3	48229259	045242521265
6	Constant swing copper tubing cutter 42 mm	3	48229252	045242521234
7	Ratcheting PVC cutter 42 mm	3	4932464172	4058546221171
8	Folding jab saw	4	48220305	045242204618

Pos	Display Material	Quantity	Article Number	EAN Code
1	MILWAUKEE® Red 1m Short Accessories Display Bar	1	4939434656	4002395557967
2	MILWAUKEE® Red 105mm Accessory Bar Euro Hook	8	4939434650	4002395557905
3	MILWAUKEE® Universal Accessories Strip	1	4939510100	4002395186433
4	Carton	1	4931373861	4002395734399
5	Re-Order Tags	1	4939435467	4058546307585

4932 478487
4058546 346805



Maxbite spanners - 1 metre row

Pos	Description	Quantity	Article Number	EAN Code
1	8mm Maxbite Combination Spanner	4	4932471516	4058546294151
2	9mm Maxbite Combination Spanner	4	4932471517	4058546294168
3	10mm Maxbite Combination Spanner	4	4932471518	4058546294175
4	11mm Maxbite Combination Spanner	4	4932471519	4058546294182
5	12mm Maxbite Combination Spanner	4	4932471520	4058546294199
6	13mm Maxbite Combination Spanner	4	4932471521	4058546294205
7	14mm Maxbite Combination Spanner	4	4932471522	4058546294212
8	15mm Maxbite Combination Spanner	4	4932471523	4058546294229
9	16mm Maxbite Combination Spanner	4	4932471524	4058546294236
10	17mm Maxbite Combination Spanner	4	4932471525	4058546294243
11	18mm Maxbite Combination Spanner	4	4932471526	4058546294250
12	19mm Maxbite Combination Spanner	4	4932471527	4058546294267
13	20mm Maxbite Combination Spanner	4	4932471528	4058546294274
14	21mm Maxbite Combination Spanner	4	4932471529	4058546294281
15	22mm Maxbite Combination Spanner	4	4932471530	4058546294298

Pos	Display Material	Quantity	Article Number	EAN Code
1	MILWAUKEE® Red 1m Short Accessories Display Bar	1	4939434656	4002395557967
2	MILWAUKEE® Red 105mm Accessory Bar Euro Hook	15	4939434650	4002395557905
3	MILWAUKEE® Universal Accessories Strip	1	4939510100	4002395186433
4	Carton	1	4931373861	4002395734399
5	Re-Order Tags	1	4939435469	4058546307608

4932 478489
4058546 346829



HVAC gripping tools - 1 metre row

Pos	Description	Quantity	Article Number	EAN Code
1	Water pump pliers 200 mm	4	48226208	045242342235
2	Water pump pliers 250 mm	4	48226210	045242342242
3	Water pump pliers 300 mm	4	48226212	045242342259
4	6" adjustable wrench.	4	48227406	045242356225
5	8" adjustable wrench.	4	48227508	045242356232
6	Basin wrench compact	4	48227001	045242366170
7	Aluminium pipe wrench 300 mm	3	48227212	045242342389
8	Adaptable pipe wrench	2	48227314	045242342402

Pos	Display Material	Quantity	Article Number	EAN Code
1	MILWAUKEE® Red 1m Short Accessories Display Bar	1	4939434656	4002395557967
2	MILWAUKEE® Red 105mm Accessory Bar Euro Hook	8	4939434650	4002395557905
3	MILWAUKEE® Universal Accessories Strip	1	4939510100	4002395186433
4	Carton	1	4931373861	4002395734399
5	Re-Order Tags	1	4939435468	4058546307592

4932 478488
4058546 346812



Maxbite ratcheting spanners - 1 metre row

Pos	Description	Quantity	Article Number	EAN Code
1	8mm Maxbite Ratcheting Combination Spanner	4	4932471501	4058546294007
2	9mm Maxbite Ratcheting Combination Spanner	4	4932471502	4058546294014
3	10mm Maxbite Ratcheting Combination Spanner	4	4932471503	4058546294021
4	11mm Maxbite Ratcheting Combination Spanner	4	4932471504	4058546294038
5	12mm Maxbite Ratcheting Combination Spanner	4	4932471505	4058546294045
6	13mm Maxbite Ratcheting Combination Spanner	4	4932471506	4058546294052
7	14mm Maxbite Ratcheting Combination Spanner	4	4932471507	4058546294069
8	15mm Maxbite Ratcheting Combination Spanner	4	4932471508	4058546294076
9	16mm Maxbite Ratcheting Combination Spanner	4	4932471509	4058546294083
10	17mm Maxbite Ratcheting Combination Spanner	4	4932471510	4058546294090
11	18mm Maxbite Ratcheting Combination Spanner	4	4932471511	4058546294106
12	19mm Maxbite Ratcheting Combination Spanner	4	4932471512	4058546294113
13	20mm Maxbite Ratcheting Combination Spanner	4	4932471513	4058546294120
14	21mm Maxbite Ratcheting Combination Spanner	4	4932471514	4058546294137
15	22mm Maxbite Ratcheting Combination Spanner	4	4932471515	4058546294144

Pos	Display Material	Quantity	Article Number	EAN Code
1	MILWAUKEE® Red 1m Short Accessories Display Bar	1	4939434656	4002395557967
2	MILWAUKEE® Red 105mm Accessory Bar Euro Hook	15	4939434650	4002395557905
3	MILWAUKEE® Universal Accessories Strip	1	4939510100	4002395186433
4	Carton	1	4931373861	4002395734399
5	Re-Order Tags	1	4939435470	4058546307615

4932 478490
4058546 346836



3/8" impact sockets - 1 metre row

Pos	Description	Total length (mm)	Quantity	Article Number	EAN Code
1	8 mm 3/8" impact socket	28	3	4932478008	4058546339418
2	10 mm 3/8" impact socket	28	3	4932478009	4058546339425
3	11 mm 3/8" impact socket	30	3	4932478010	4058546339432
4	12 mm 3/8" impact socket	30	3	4932478011	4058546339449
5	13 mm 3/8" impact socket	30	3	4932478012	4058546339456
6	14 mm 3/8" impact socket	30	3	4932478013	4058546339463
7	15 mm 3/8" impact socket	30	3	4932478014	4058546339470
8	16 mm 3/8" impact socket	30	3	4932478015	4058546339487
9	17 mm 3/8" impact socket	32	3	4932478016	4058546339494
10	18 mm 3/8" impact socket	32	3	4932478017	4058546339500
11	19 mm 3/8" impact socket	32	3	4932478018	4058546339517
12	21 mm 3/8" impact socket	32	3	4932478019	4058546339524
13	22 mm 3/8" impact socket	32	3	4932478020	4058546339531
①	14 Socket adaptor: 3/8" square - 1/2" square		3	4932478051	4058546339845
②	15 Socket adaptor: 3/8" square - 1/4" square		3	4932478052	4058546339852
③	16 3/8" SHOCKWAVE [™] IMPACT DUTY socket set (8 pc)		3	4932478288	4058546344658

Pos	Display Material	Quantity	Article Number	EAN Code
1	MILWAUKEE [®] Red 1m Short Accessories Display Bar	1	4939434656	4002395557967
2	MILWAUKEE [®] Red 105mm Accessory Bar Euro Hook	16	4939434650	4002395557905
3	MILWAUKEE [®] Universal Accessories Strip	1	4939510100	4002395186433
4	Carton	1	4931373861	4002395734399
5	Re-Order Tags	1	4939710700	4058546308940

4932 478592
4058546 347857



3/8" impact sockets deep - 1 metre row

Pos	Description	Total length (mm)	Quantity	Article Number	EAN Code
1	8 mm 3/8" impact socket - deep	63	3	4932478021	4058546339548
2	10 mm 3/8" impact socket - deep	63	3	4932478022	4058546339555
3	11 mm 3/8" impact socket - deep	63	3	4932478023	4058546339562
4	12 mm 3/8" impact socket - deep	63	3	4932478024	4058546339579
5	13 mm 3/8" impact socket - deep	63	3	4932478025	4058546339586
6	14 mm 3/8" impact socket - deep	63	3	4932478026	4058546339593
7	15 mm 3/8" impact socket - deep	63	3	4932478027	4058546339609
8	16 mm 3/8" impact socket - deep	63	3	4932478028	4058546339616
9	17 mm 3/8" impact socket - deep	63	3	4932478029	4058546339623
10	18 mm 3/8" impact socket - deep	63	3	4932478030	4058546339630
11	19 mm 3/8" impact socket - deep	63	3	4932478031	4058546339647
12	21 mm 3/8" impact socket - deep	63	3	4932478032	4058546339654
13	22 mm 3/8" impact socket - deep	63	3	4932478033	4058546339661
①	14 Socket adaptor: 3/8" square - 1/2" square		3	4932478051	4058546339845
②	15 3/8" SHOCKWAVE [™] IMPACT DUTY socket set deep (8 pc)		3	4932478289	4058546344665

Pos	Display Material	Quantity	Article Number	EAN Code
1	MILWAUKEE [®] Red 1m Short Accessories Display Bar	1	4939434656	4002395557967
2	MILWAUKEE [®] Red 105mm Accessory Bar Euro Hook	15	4939434650	4002395557905
3	MILWAUKEE [®] Universal Accessories Strip	1	4939510100	4002395186433
4	Carton	1	4931373861	4002395734399
5	Re-Order Tags	1	4939710701	4058546308957

4932 478593
4058546 347864



1/2" impact sockets - 1 metre row

Pos	Description	Total length (mm)	Quantity	Article Number	EAN Code
1	8 mm 1/2" impact socket	38	3	4932478034	4058546339678
2	10 mm 1/2" impact socket	38	3	4932478035	4058546339685
3	11 mm 1/2" impact socket	38	3	4932478036	4058546339692
4	12 mm 1/2" impact socket	38	3	4932478037	4058546339708
5	13 mm 1/2" impact socket	38	3	4932478038	4058546339715
6	14 mm 1/2" impact socket	38	3	4932478039	4058546339722
7	15 mm 1/2" impact socket	38	3	4932478040	4058546339739
8	16 mm 1/2" impact socket	38	3	4932478041	4058546339746
9	17 mm 1/2" impact socket	38	3	4932478042	4058546339753
10	18 mm 1/2" impact socket	38	3	4932478043	4058546339760
11	19 mm 1/2" impact socket	40	3	4932478044	4058546339777
12	21 mm 1/2" impact socket	40	3	4932478045	4058546339784
13	22 mm 1/2" impact socket	42	3	4932478046	4058546339791
14	24 mm 1/2" impact socket	44	3	4932478047	4058546339807
15	27 mm 1/2" impact socket	46	3	4932478048	4058546339814
16	30 mm 1/2" impact socket	46	3	4932478049	4058546339821
17	32 mm 1/2" impact socket	46	3	4932478050	4058546339838

Pos	Display Material	Quantity	Article Number	EAN Code
1	MILWAUKEE® Red 1m Short Accessories Display Bar	1	4939434656	4002395557967
2	MILWAUKEE® Red 105mm Accessory Bar Euro Hook	17	4939434650	4002395557905
3	MILWAUKEE® Universal Accessories Strip	1	4939510100	4002395186433
4	Carton	1	4931373861	4002395734399
5	Re-Order Tags	1	4939710702	4058546308964

4932 478594
4058546 347871



1/2" impact sockets deep - 1 metre row

Pos	Description	Total length (mm)	Quantity	Article Number	EAN Code
1	8 mm 1/2" impact socket - deep	78	3	4932352847	4002395375059
2	10 mm 1/2" impact socket - deep	78	3	4932352848	4002395375066
3	11 mm 1/2" impact socket - deep	78	3	4932352849	4002395375073
4	12 mm 1/2" impact socket - deep	78	3	4932352850	4002395375080
5	13 mm 1/2" impact socket - deep	78	3	4932352851	4002395375097
6	14 mm 1/2" impact socket - deep	78	3	4932352852	4002395375103
7	15 mm 1/2" impact socket - deep	78	3	4932471737	4058546296360
8	16 mm 1/2" impact socket - deep	78	3	4932352853	4002395375110
9	17 mm 1/2" impact socket - deep	78	3	4932352854	4002395375127
10	18 mm 1/2" impact socket - deep	78	3	4932471738	4058546296377
11	19 mm 1/2" impact socket - deep	78	3	4932352855	4002395375134
12	21 mm 1/2" impact socket - deep	78	3	4932352856	4002395375141
13	22 mm 1/2" impact socket - deep	78	3	4932471166	4058546287948
14	24 mm 1/2" impact socket - deep	78	3	4932352857	4002395375158
15	27 mm 1/2" impact socket - deep	78	3	4932352858	4002395375165
16	30 mm 1/2" impact socket - deep	78	3	4932352859	4002395375172
17	32 mm 1/2" impact socket - deep	78	3	4932352860	4002395375189

Pos	Display Material	Quantity	Article Number	EAN Code
1	MILWAUKEE® Red 1m Short Accessories Display Bar	1	4939434656	4002395557967
2	MILWAUKEE® Red 105mm Accessory Bar Euro Hook	17	4939434650	4002395557905
3	MILWAUKEE® Universal Accessories Strip	1	4939510100	4002395186433
4	Carton	1	4931373861	4002395734399
5	Re-Order Tags	1	4939710703	4058546308971

4932 478595
4058546 347888



SDS-Plus MX4 4 cut drill bits - 1 metre row



Pos	Ø mm	A mm	B mm	Quantity	Id. No. 4932	EAN Code 4002395
1	5	115	50	5	352007	366644
2	6	115	50	5	352011	368921
3	6	165	100	5	352012	368938
4	6	215	150	5	352013	366705
5	6	265	200	5	352014	366712
6	8	115	50	5	352021	366781
7	8	165	100	5	352022	366798
8	8	215	150	5	352023	366804
9	8	265	200	5	352024	366811
10	10	115	50	5	352025	366828
11	10	165	100	5	352026	366835
12	10	215	150	5	352027	366842
13	10	265	200	5	352028	366859
14	12	160	100	5	352031	366880
15	12	210	150	5	352032	366897
16	12	260	200	5	352033	366903
17	14	160	100	5	352036	366934
18	14	210	150	5	352037	366941

4932 430493
4002395 381548

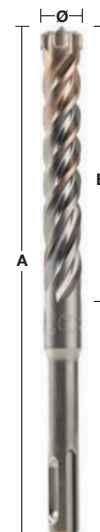

Pos	Display material	Quantity	Id. No. 4939	EAN Code 4002395
1	1 m Assembled row	1	434656	557967
2	Euro hook (short)	18	434650	557905
3	MILWAUKEE® header strip	1	510100	900596
4	Barcode label strip MX4 drill bits EU	1	565571	937516
5	Carton	1	4931373861	734399

SDS-Plus M2 2 cut drill bits - 1 metre row



Pos	Ø mm	A mm	B mm	Quantity	Id. No. 4932	EAN Code 4002395
1	4	110	50	5	339498	304561
2	5	110	50	5	307067	308835
3	6	110	50	5	307068	308842
4	6	160	100	5	307069	308859
5	6	260	200	5	353819	320127
6	8	110	50	5	307070	308866
7	8	160	100	5	307071	308873
8	8	210	150	5	307072	308880
9	8	260	200	5	353821	320141
10	10	110	50	5	340410	311934
11	10	160	100	5	307073	308897
12	10	210	150	5	307074	308903
13	10	260	200	5	344295	312252
14	12	160	100	5	307075	308910
15	12	210	150	5	307076	308927
16	14	160	100	5	307078	308941
17	16	210	150	5	307081	308972
18	18	200	150	3	344303	312177
19	20	200	150	3	344305	312153

4932 430494
4002395 381555

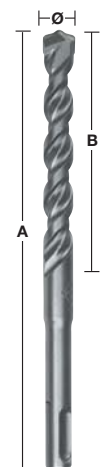

Pos	Display material	Quantity	Id. No. 4939	EAN Code 4002395
1	1 m Assembled row	1	434656	557967
2	Euro hook (short)	19	434650	557905
3	MILWAUKEE® header strip	1	510100	900596
4	Barcode label strip SDS-Plus drill bits EU	1	530434	914135
5	Carton	1	4931373861	734399

SDS-Plus M2 2 cut drill bits long - 1 metre row



Pos	Ø mm	A mm	B mm	Quantity	Id. No. 4932	EAN Code 4002395
1	8	460	400	5	367013	336692
2	10	310	250	5	353824	320172
3	10	450	400	5	344296	312245
4	12	260	200	5	344297	312238
5	12	450	400	5	307077	308934
6	14	260	200	5	307079	308958
7	14	450	400	5	307088	309047
8	15	260	200	5	344300	312207
9	16	310	250	5	344301	312191
10	16	450	400	5	307082	308989
11	18	250	200	3	307083	308996
12	18	450	400	3	340411	311941
13	20	250	200	3	307084	309009
14	20	450	400	2	307085	309016
15	22	450	400	3	344307	312139
16	24	450	400	3	307087	309030

4932 430495
4002395 381562

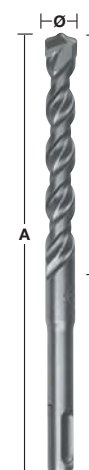
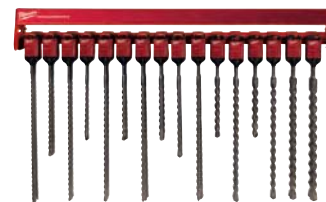

Pos	Display material	Quantity	Id. No. 4939	EAN Code 4002395
1	1 m Assembled row	1	434656	557967
2	Euro hook (short)	16	434650	557905
3	MILWAUKEE® header strip	1	510100	900596
4	Barcode label strip SDS-Plus drill bits long EU	1	530436	914135
5	Carton	1	4931373861	734399

TID-extra
Industrial Technologies d.o.o.

SDS-Plus M2 2 cut drill bits & chisels - 1 metre row



Pos	Ø mm	A mm	B mm	Quantity	Id. No. 4932	EAN Code 4002395
① 1	5	110	50	5	307067	308835
2	6	110	50	5	307068	308842
3	6	160	100	5	307069	308859
4	8	110	50	5	307070	308866
5	8	160	100	5	307071	308873
6	8	210	150	5	307072	308880
7	10	160	100	5	307073	308897
8	10	210	150	5	307074	308903
9	12	160	100	5	307075	308910
10	14	160	100	5	307078	308941
11	16	210	150	5	307081	308972
12	18	200	150	3	344303	312177
13	20	200	150	3	344305	312153

4932 430496
4002395 381579

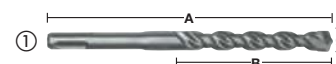

② 14	7pc SDS-Plus 2 cut set with Ø 5/6/8x110 mm and Ø 6/8/10/12x160 mm		3	352339	369980	
③ 15	Pointed chisel	250	-	5	339625	304813
④ 16	Wide chisel	250	40	5	367146	334377
⑤ 17	Flat chisel	250	20	5	339626	304820

Pos	Display material	Quantity	Id. No. 4939	EAN Code 4002395
1	1 m Assembled row	1	434656	557967
2	Euro hook (short)	17	434650	557905
3	MILWAUKEE® header strip	1	510100	900596
4	Barcode label strip SDS-Plus drill bits & chisels EU	1	530442	914005
5	Carton	1	4931373861	734399

MERCHANDISING SOLUTIONS

SDS-Max drill bits & chisels - 1 metre row

Pos	Ø mm	A mm	B mm	Quantity	Id. No. 4932	EAN Code 4002395	
①	1	16	340	200	3	352756	374144
	2	16	540	400	2	352757	374151
	3	18	540	400	3	352761	374199
	4	20	520	400	3	352765	374236
	5	22	520	400	3	352769	374274
	6	24	520	400	2	352773	374311
	7	25	520	400	2	352775	374335
	8	28	570	450	2	352779	374373
	9	30	570	450	2	352784	374427
	10	32	570	450	1	352786	374441
	11	35	570	450	2	352790	374489
②	12	Pointed chisel	280	-	3	343734	317509
	13	Pointed chisel	400	-	3	343735	317516
③	14	Flat chisel	280	25	3	343737	317530
	15	Flat chisel	400	25	3	343738	317547
④	16	Wide chisel	400	50	3	343743	317592
	17	Wide chisel	300	80	3	343744	317608

Pos	Display material	Quantity	Id. No. 4939	EAN Code 4002395
1	1 m Assembled row	1	434656	557967
2	Euro hook (short)	6	434650	557905
3	Single hook (short)	11	434652	557929
4	MILWAUKEE® header strip	1	510100	900596
5	Barcode label strip SDS-Max drill bits & chisels EU	1	530294	914838
6	Carton	1	4931373861	734399

4932 430497
4002395 381586

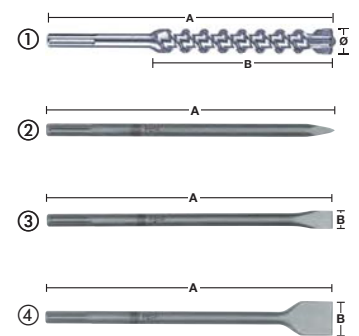

SDS-Plus & SDS-Max chisels - 1 metre row

Pos	Type	A mm	B mm	Quantity	Id. No. 4932	EAN Code 4002395	
SDS-Plus							
①	1	Pointed chisel	250	-	5	339625	304813
②	2	Wide chisel	250	40	5	367146	334377
③	3	Flat chisel	250	20	5	339626	304820
④	4	Chasing goug. chisel	250	25	3	339627	304837
⑤	5	Tile chisel	250	40	3	353424	320202
SDS-Max							
①	6	Pointed chisel	280	-	4	343734	317509
①	7	Pointed chisel	400	-	4	343735	317516
①	8	Pointed chisel	600	-	3	343736	317523
②	9	Flat chisel	280	25	5	343737	317530
③	10	Flat chisel	400	25	5	343738	317547
③	11	Flat chisel	600	25	3	343739	317554
②	12	Wide chisel	400	50	4	343743	317592
②	13	Wide chisel	300	80	4	343744	317608
②	14	Wide chisel	300	115	3	343745	317615

Pos	Display material	Quantity	Id. No. 4939	EAN Code 4002395
1	1 m Assembled row	1	434656	557967
2	Euro hook (short)	14	434650	557905
3	MILWAUKEE® header strip	1	510100	900596
4	Barcode label strip SDS-Plus & SDS-Max chisels EU	1	530297	914807
5	Carton	1	4931373861	734399

4932 430498
4002395 381593

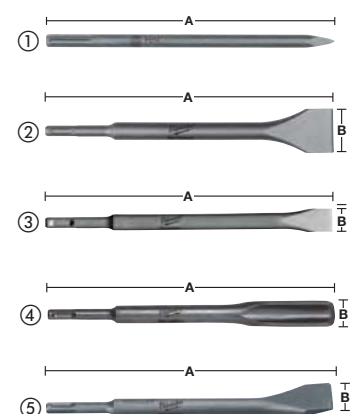

Concrete drill bits round shank - DIN 8039 - 1 metre row

Pos	Ø mm	A mm	B mm	Quantity	Id. No. 4932	EAN Code 4002395
① 1	4	85	50	5	363631	332014
2	5	85	50	5	363633	332038
3	5	150	90	5	363634	332045
4	6	100	60	5	363636	332069
5	6	150	90	5	363637	332076
6	8	120	80	5	363640	332106
7	8	200	150	5	363641	332113
8	9	120	80	5	363643	332137
9	10	120	80	5	363644	332144
10	10	200	150	5	363645	332151
11	12	150	85	5	363647	332175
12	12	200	150	5	363648	332182
13	14	150	90	5	363650	332205
② 14	8pc concrete bit round shank set with Ø 3/4/5/6/7/8/9/10 mm			3	352334	369935

Pos	Display material	Quantity	Id. No. 4939	EAN Code 4002395
1	1 m Assembled row	1	434656	557967
2	Euro hook (short)	14	434650	557905
3	MILWAUKEE® header strip	1	510100	900596
4	Barcode label strip concrete drill bits EU	1	530391	914364
5	Carton	1	4931373861	734399

4932 430499
4002395 381609

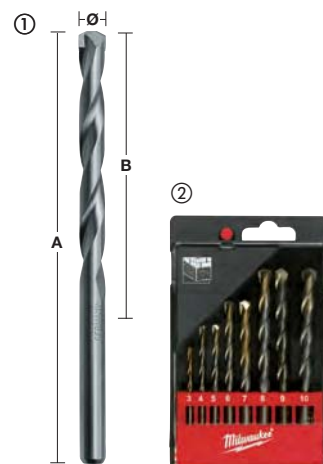

RED HEX HSS-G TiN metal drill bits - 1 metre row

NEW

Pos	Ø mm	A mm	B mm	Quantity	Id. No.	EAN Code 4002395
1	2.0	59.5	17	5	48894703	1557
2	2.5	62	19	5	48894704	1564
3	3.5	69	25	5	48894707	1588
4	4.0	71.5	26	5	48894708	1595
5	4.5	76	29	5	48894710	1618
6	5.0	93	46	5	48894712	1632
7	6.0	105	60	5	48894714	1649
8	7.0	109	65	5	48894717	1670
9	8.0	111	67	5	48894719	1694
10	9.0	117	73	5	48894721	1717
11	10.0	120	76	5	48894723	1731
12	11.0	125	81	5	48894725	1755
13	12.0	127	83	5	48894727	1779
14	13.0	130	85	5	48894729	1793
15	3.0	65	23	5	48894763	2066
16	5.5	104	59	5	48894764	6866
17	Shockwave HSS-G TiN Red Hex drill bit set in plastic cassette (10 pcs) with Ø 3/3.5/4/4.5/5/6/7/8/9/10 mm			3	48894759	6873

Pos	Display material	Quantity	Id. No. 4939	EAN Code 4002395
1	1 m Assembled row	1	434656	557967
2	Euro hook (short)	17	434650	557905
3	MILWAUKEE® header strip	1	510100	900596
4	Barcode label strip HSS-G drill bits EU	1	530356	914722
5	Carton	1	4931373861	734399

4932 471739
4058546 296384

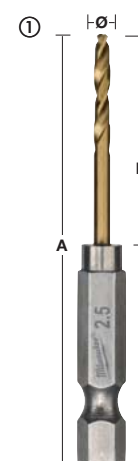

THUNDERWEB Metal drill bits HSS Ground - DIN 338 - 1 metre row

Pos	Ø mm	A mm	B mm	Quantity	Id. No. 4932	EAN Code 4002395
1	1.0	34	12	5	352345	370047
2	1.5	40	18	5	352346	370054
3	2.0	49	24	5	352347	370061
4	2.5	57	30	5	352348	370078
5	3.0	61	33	5	352349	370085
6	3.2	65	36	5	352350	370092
7	3.5	70	39	5	352351	370108
8	4.0	75	43	5	352352	370115
9	4.5	80	47	5	352354	370139
10	5.0	86	52	5	352356	370153
11	6.0	93	57	5	352358	370177
12	7.0	109	69	5	352361	370207
13	8.0	117	75	5	352363	370221
14	9.0	125	81	5	352365	370245
15	10.0	133	87	5	352367	370269
16	11.0	142	94	5	352369	370283
17	12.0	151	101	5	352371	370306
18	13.0	151	101	5	352373	370320

Pos	Display material	Quantity	Id. No. 4939	EAN Code 4002395
1	1 m Assembled row	1	434656	557967
2	Euro hook (short)	18	434650	557905
3	MILWAUKEE® header strip	1	510100	900596
4	Barcode label strip HSS-G drill bits EU	1	530356	914722
5	Carton	1	4931373861	734399

4932 430500
4002395 381616

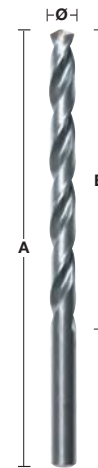

RED COBALT - HSS-Ground - DIN 338 Metal drill bits - 1 metre row

Pos	Ø mm	A mm	B mm	Quantity	Id. No. 4932	EAN Code 4002395
1	1.0	34	12	5	363248	333080
2	1.5	40	18	5	363249	333097
3	2.0	49	24	5	363250	333103
4	2.5	57	30	5	363251	333110
5	3.0	61	33	5	363253	333134
6	3.2	65	36	5	363254	333141
7	3.5	70	39	5	363256	333165
8	4.0	75	43	5	363258	333189
9	4.5	80	47	5	363262	333226
10	5.0	86	52	5	363264	333240
11	5.5	93	57	5	363267	333271
12	6.0	93	57	5	363268	333288
13	6.5	101	63	5	363269	333295
14	7.0	109	69	5	363271	333318
15	8.0	117	75	5	363274	333349
16	8.5	117	75	5	363276	333363
17	9.0	125	81	5	363277	333370
18	10.0	133	87	5	363279	333394
19	11.0	142	94	5	363282	333424
20	12.0	151	101	5	363284	333448
21	13.0	151	101	5	363286	333462

Pos	Display material	Quantity	Id. No. 4939	EAN Code 4002395
1	1 m Assembled row	1	434656	557967
2	Euro hook (short)	21	434650	557905
3	MILWAUKEE® header strip	1	510100	900596
4	Barcode label strip HSS-Co drill bits EU	1	530366	914623
5	Carton	1	4931373861	734399

4932 430501
4002395 381623



Wood auger bits 230 mm - 1 metre row

Pos	Ø mm	A mm	B mm	C mm	Quantity	Id. No. 4932	EAN Code 4002395
1	8	230	155	6.5	3	363681	331796
2	10	230	155	8.5	3	363682	331802
3	12	230	155	10	3	363683	331819
4	14	230	155	11	3	363684	331826
5	16	230	155	11	3	363685	331833
6	18	230	155	11	3	363686	331840
7	20	230	155	11	3	363687	331857
8	22	230	155	11	3	373363	347889
9	24	230	155	11	3	373364	347896
10	26	230	155	11	3	373365	348503
11	28	230	155	11	3	373366	348510
12	30	230	155	11	3	373367	348527
13	32	230	155	11	2	373368	348534

Pos	Display material	Quantity	Id. No. 4939	EAN Code 4002395
1	1 m Assembled row	1	434656	557967
2	Euro hook (short)	13	434650	557905
3	MILWAUKEE® header strip	1	510100	900596
4	Barcode label strip wood auger bits 230 mm EU	1	530395	914326
5	Carton	1	4931373861	734399

4932 430502
4002395 381630



Wood auger bits 460 mm - 1 metre row

Pos	Ø mm	A mm	B mm	C mm	Quantity	Id. No. 4932	EAN Code 4002395
1	8	460	385	6.5	3	363688	331710
2	10	460	385	8.5	3	363689	331727
3	12	460	385	10	3	363690	331734
4	14	460	385	11	3	363691	331741
5	16	460	385	11	3	363692	331758
6	18	460	385	11	3	363693	331765
7	20	460	385	11	3	363694	331772
8	22	460	385	11	3	363695	331789
9	24	460	385	11	3	373370	348558
10	26	460	385	11	3	373371	348565
11	28	460	385	11	3	373372	348572
12	30	460	385	11	3	373373	348589
13	32	460	385	11	2	373374	348596

Pos	Display material	Quantity	Id. No. 4939	EAN Code 4002395
1	1 m Assembled row	1	434656	557967
2	Euro hook (short)	13	434650	557905
3	MILWAUKEE® header strip	1	510100	900596
4	Barcode label strip wood auger bits 460 mm EU	1	530256	914852
5	Carton	1	4931373861	734399

4932 430503
4002395 381647

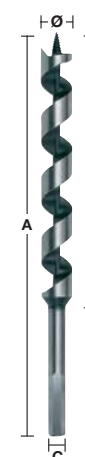

Brad point drill bits for wood - DIN 7487 E - 1 metre row

Pos	Ø mm	A mm	B mm	C mm	Quantity	Id. No. 4932	EAN Code 4002395
1	3	60	33	3	5	363651	331307
2	4	75	43	4	5	363652	331314
3	5	86	52	5	5	363653	331321
4	6	97	60	6	5	363654	331338
5	7	109	69	7	5	363655	331345
6	8	117	75	8	5	363656	331352
7	9	125	80	9	5	363657	331369
8	10	133	87	10	5	363658	331376
9	11	142	89	10	5	363659	331383
10	12	151	96	10	5	363660	331390
11	13	151	96	10	5	363661	331406
12	14	151	97	10	5	363662	331413
13	15	151	97	10	5	363663	331420
14	16	151	97	10	5	363664	331437
15	18	180	120	10	5	363665	331444
16	20	200	130	10	5	363666	331451

Pos	Display material	Quantity	Id. No. 4939	EAN Code 4002395
1	1 m Assembled row	1	434656	557967
2	Euro hook (short)	16	434650	557905
3	MILWAUKEE® header strip	1	510100	900596
4	Barcode label strip brad point drill bits for wood EU	1	530261	914890
5	Carton	1	4931373861	734399

4932 430504
4002395 381654



Flat boring bits 152 mm - 1 metre row

Pos	Ø mm	A mm	Quantity	Id. No. 4932	EAN Code 4002395
1	8	152	5	363130	332618
2	10	152	5	363131	332625
3	12	152	5	363132	332632
4	13	152	5	363133	332649
5	14	152	5	363134	332656
6	16	152	5	363135	332663
7	18	152	5	363136	332670
8	19	152	5	363137	332687
9	20	152	5	363138	332694
10	22	152	5	363139	332700
11	24	152	5	363140	332717
12	25	152	5	363141	332724
13	26	152	5	363142	332731
14	28	152	5	363143	332748
15	30	152	5	363144	332755
16	32	152	5	363145	332762
17	36	152	5	363146	332779
18	38	152	5	363147	332786

Pos	Display material	Quantity	Id. No. 4939	EAN Code 4002395
1	1 m Assembled row	1	434656	557967
2	Euro hook (short)	18	434650	557905
3	MILWAUKEE® header strip	1	510100	900596
4	Barcode label strip flat boring bits 160 mm EU	1	530259	914883
5	Carton	1	4931373861	734399

4932 430505
4002395 381661



SHOCKWAVE™ IMPACT DUTY drilling & driving - 1 metre row

Pos	Size	A mm	Quantity	Id. No. 4932	EAN Code 4002395	
①	1	PH 1	25	5	430850	385126
	2	PH 2	25	5	430852	385140
	3	PH 2	50	5	430854	385164
	4	PZ 1	25	5	430860	385225
	5	PZ 2	25	5	430863	385256
	6	PZ 2	50	5	430865	385270
	7	PZ 3	25	5	430868	385300
	8	TX 15	25	5	430872	385348
	9	TX 20	25	5	430874	385362
	10	TX 25	25	5	430879	385416
	11	TX 30	25	5	430885	385478
②	12	Magnetic bit holder 60 mm length	5	352406	370658	
③ Magnetic nut drivers						
	13	Hex 8	65	4	352541	370726
	14	Hex 10	65	4	352543	370740
	15	Hex 13	65	4	352545	370764

4932 451316
4002395 151981



④	16	SHOCKWAVE™ HSS-G TINI Red Hex drill bit set in plastic cassette (10 pcs) with Ø 3/3.5/4/4.5/5/6/7/8/9/10 mm	3	48894759	045242502066
---	----	---	---	----------	--------------

Pos	Display material	Quantity	Id. No. 4939	EAN Code 4002395
1	1 m Assembled row	1	434656	557967
2	Euro hook (short)	16	434650	557905
3	MILWAUKEE® header strip	1	510100	900596
4	Barcode label strip SHOCKWAVE™ EU	1	434828	192038
5	Carton	1	4931373861	734399

Jigsaw blades for wood, plastics & metal - 1 metre row

Pos	Blade length (toothed) mm	Tooth pitch mm	Ref. No.	Quantity	Id. No. 4932	EAN Code 4002395
1	55	1.2	T 118 A	5	254063	301614
2	91	2.5/1.8	T 123 XF	5	430142	378036
3	75	3.0	T 127 D	5	274315	301560
4	75	4.0	T 144 D	5	213116	301492
5	75	2.5	T 101 B	5	254061	301522
6	66	4.0	T 101 D	5	274351	301515
7	55	2.5	Curve	5	430143	378043
8	91	2.5	T 234 X	5	430141	378029
9	105	4.0	T 344 D	5	311633	301508
10	5pc jigsaw blade set with 213116, 254061, 254063, 254064, 254071			5	345825	314850

4932 430508
4002395 381692



Pos	Display material	Quantity	Id. No. 4939	EAN Code 4002395
1	1 m Assembled row	1	434656	557967
2	Euro hook (short)	10	434650	557905
3	MILWAUKEE® header strip	1	510100	900596
4	Barcode label strip jigsaw blades top line EU	1	530372	914555
5	Carton	1	4931373861	734399

Jigsaw blades for wood & plastics - 1 metre row

Pos	Blade length (toothed) mm	Tooth pitch mm	Ref. No.	Quantity	Id. No. 4932	EAN Code 4002395
1	75	4.0	T 144 D	5	213116	301492
2	75	2.5	T 101 B	5	254061	301522
3	105	4.0	T 301 DL	5	346071	312399
4	75	4.0	T 101 D	5	274351	301515
5	91	2.5	T 234 X	5	430141	378029
6	75	2.5	T 101 BR	5	346079	312382
7	75	2.5/1.2	Curve	5	430143	378043
8	105	4.0	T 344 D	5	311633	301508
9	75	3.0	T 111 C	5	254071	301539
10	5pc jigsaw blade set with 213116, 254061, 254063, 254064, 254071			5	345825	314850

Pos	Display material	Quantity	Id. No. 4939	EAN Code 4002395
1	1 m Assembled row	1	434656	557967
2	Euro hook (short)	10	434650	557905
3	MILWAUKEE® header strip	1	510100	900596
4	Barcode label strip jigsaw blades for wood & plastics EU	1	530376	914517
5	Carton	1	4931373861	734399

4932 430509
4002395 381708



Jigsaw blades for metal - 1 metre row

Pos	Blade length (toothed) mm	Tooth pitch mm	Ref. No.	Quantity	Id. No. 4932	EAN Code 4002395
1	55	1.2	T 118 A	5	254063	301614
2	55	2.0	T 118 B	5	254064	301591
3	75	3.0	T 127 D	5	274315	301560
4	75	1.2	T 118 AF	5	340011	304684
5	91	2.5/1.8	T 123 XF	5	430142	378036
6	66	1.2	T 118 A sp.	5	345826	313464
7	55	0.7	T 118 G	5	274652	301621
8	105	1.2	T 318 AF	5	274654	301607
9	105	2.0	T 318 BF	5	274653	301584
10	5pc jigsaw blade set with 213116, 254061, 254063, 254064, 254071			5	345825	314850

Pos	Display material	Quantity	Id. No. 4939	EAN Code 4002395
1	1 m Assembled row	1	434656	557967
2	Euro hook (short)	10	434650	557905
3	MILWAUKEE® header strip	1	510100	900596
4	Barcode label strip jigsaw blades for metal EU	1	530379	914487
5	Carton	1	4931373861	734399

4932 430510
4002395 381715



Abrasive paper - Hook & Loop 100x147 mm - 1 metre row

Pos	Grit	Paper size mm A x B	Quantity	Id. No. 4932	EAN Code 4002395
1	60	100x147	3	355140	319992
2	60	100x147	3	355140	319992
3	80	100x147	3	355141	320004
4	80	100x147	3	355141	320004
5	120	100x147	3	355142	320011
6	180	100x147	3	355143	320028
7	240	100x147	3	355144	320035

Pos	Display material	Quantity	Id. No. 4939	EAN Code 4002395
1	1 m Assembled row	1	434656	557967
2	Euro hook (short)	7	434650	557905
3	MILWAUKEE® header strip	1	510100	900596
4	Barcode label strip abrasive paper 100x147 mm EU	1	530281	915071
5	Carton	1	4931373861	734399

4932 430511
4002395 381722

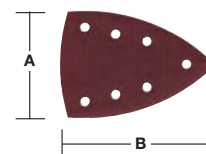

Abrasive paper - Hook & Loop 105x105 mm - 1 metre row

Pos	Grit	Paper size mm A x B	Quantity	Id. No. 4932	EAN Code 4002395
1	60	105x105	3	358492	324248
2	60	105x105	3	358492	324248
3	80	105x105	3	358493	324255
4	80	105x105	3	358493	324255
5	120	105x105	3	358494	324262
6	180	105x105	3	358495	324279
7	240	105x105	3	358496	324286

Pos	Display material	Quantity	Id. No. 4939	EAN Code 4002395
1	1 m Assembled row	1	434656	557967
2	Euro hook (short)	8	434650	557905
3	MILWAUKEE® header strip	1	510100	900596
4	Barcode label strip abrasive paper 105x105 mm EU	1	530285	915118
5	Carton	1	4931373861	734399

4932 430557
4002395 382187

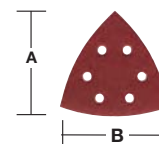

Abrasive paper - Hook & Loop Ø 125 mm 8 holes - 1 metre row

Pos	Grit	Paper size mm Ø	Quantity	Id. No. 4932	EAN Code 4002395
1	40	125	3	367740	338610
2	60	125	3	367741	338627
3	60	125	3	367741	338627
4	80	125	3	367742	338634
5	120	125	3	367743	338641
6	180	125	3	367744	338658
7	240	125	3	367745	338665

Pos	Display material	Quantity	Id. No. 4939	EAN Code 4002395
1	1 m Assembled row	1	434656	557967
2	Euro hook (short)	7	434650	557905
3	MILWAUKEE® header strip	1	510100	900596
4	Barcode label strip abrasive paper Ø 125 mm EU	1	530422	914258
5	Carton	1	4931373861	734399

4932 430512
4002395 381739

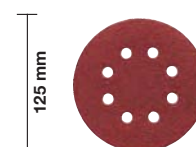

Abrasive paper - Hook & Loop Ø 150 mm 6 holes - 1 metre row

Pos	Grit	Paper size mm Ø	Quantity	Id. No. 4932	EAN Code 4002395
1	40	150	3	371590	343171
2	60	150	3	371591	343188
3	80	150	3	371592	343195
4	120	150	3	371593	343201
5	180	150	3	371594	343218
6	240	150	3	371595	343225

Pos	Display material	Quantity	Id. No. 4939	EAN Code 4002395
1	1 m Assembled row	1	434656	557967
2	Euro hook (short)	6	434650	557905
3	MILWAUKEE® header strip	1	510100	900596
4	Barcode label strip abrasive paper Ø 150 mm EU	1	530399	914289
5	Carton	1	4931373861	734399

4932 430513
4002395 381746

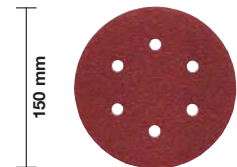

Abrasive belts - 100x620 mm - 1 metre row

Pos	Grit	Paper size mm A x B	Quantity	Id. No. 4932	EAN Code 4002395
1	40	100 x 620	2	341610	304882
2	60	100 x 620	2	341611	304899
3	60	100 x 620	2	341611	304899
4	80	100 x 620	2	341612	304905
5	100	100 x 620	2	341613	304912
6	150	100 x 620	2	341614	304929
7	240	100 x 620	2	341615	304936

Pos	Display material	Quantity	Id. No. 4939	EAN Code 4002395
1	1 m Assembled row	1	434656	557967
2	Euro hook (short)	7	434650	557905
3	MILWAUKEE® header strip	1	510100	900596
4	Barcode label strip abrasive belts 100x620 mm EU	1	530425	914227
5	Carton	1	4931373861	734399

4932 430558
4002395 382194

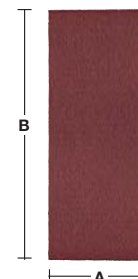

Abrasive belts - 100x610 mm - 1 metre row

Pos	Grit	Paper size mm A x B	Quantity	Id. No. 4932	EAN Code 4002395
1	40	100 x 610	2	355066	319824
2	60	100 x 610	2	355067	319831
3	60	100 x 610	2	355067	319831
4	80	100 x 610	2	355068	319848
5	100	100 x 610	2	355069	319855
6	150	100 x 610	2	355070	319862
7	240	100 x 610	2	355071	319879

Pos	Display material	Quantity	Id. No. 4939	EAN Code 4002395
1	1 m Assembled row	1	434656	557967
2	Euro hook (short)	7	434650	557905
3	MILWAUKEE® header strip	1	510100	900596
4	Barcode label strip abrasive belts 100x610 mm EU	1	530428	914227
5	Carton	1	4931373861	734399

4932 430559
4002395 382200

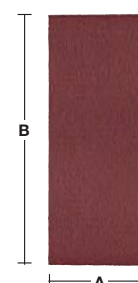

Abrasive belts - 75x533 mm - 1 metre row

Pos	Grit	Paper size mm A x B	Quantity	Id. No. 4932	EAN Code 4002395
1	40	75 x 533	2	312475	301263
2	60	75 x 533	2	312476	301270
3	60	75 x 533	2	312476	301270
4	80	75 x 533	2	312477	301287
5	80	75 x 533	2	312477	301287
6	100	75 x 533	2	312478	301294
7	100	75 x 533	2	312478	301294
8	150	75 x 533	2	312479	301300
9	240	75 x 533	2	312480	301317

Pos	Display material	Quantity	Id. No. 4939	EAN Code 4002395
1	1 m Assembled row	1	434656	557967
2	Euro hook (short)	9	434650	557905
3	MILWAUKEE® header strip	1	510100	900596
4	Barcode label strip abrasive belts 75 x 533 mm EU	1	530429	914180
5	Carton	1	4931373861	734399

4932 430514
4002395 381753

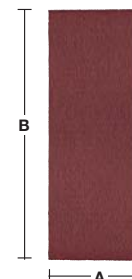

SAWZALL™ blades for wood/ demolition/universal - 1 metre row

Pos	Blade length	Teeth per inch	Application	Quantity	Id. No.	EAN Code 45242
1	230	6	Wood	5	48005016	082636
2	300	6	Wood	5	48001079	079858
3	150	5	Demolition	5	48005035	082698
4	230	5	Demolition	5	48005036	082704
5	300	5	Demolition	5	48005037	082711
6	150	5	Demolition AX	5	48005021	082988
7	230	5	Demolition AX	5	48005026	082995
8	300	5	Demolition AX	5	48005027	083022
9	150	10/14	Universal	5	48005292	084067
10	200	10/14	Universal	5	48005293	084074
11	150	8/12	Universal	5	48005091	082759
12	200	8/12	Universal	5	48005093	082773
13	300	8/12	Universal	5	48005094	082780
14	300	knife	Insulation mat.	5	48001084	079902
15	125	6	Drywall	5	48005052	082735

Pos	Display material	Quantity	Id. No. 4939	EAN Code 4002395
1	1 m Assembled row	1	434656	557967
2	Euro hook (short)	15	434650	557905
3	MILWAUKEE® header strip	1	510100	900596
4	Barcode label strip SAWZALL™ blades for wood/ demolition/ universal	1	565538	936236
5	Carton	1	4931373861	734399

4932 430515
4002395 381760

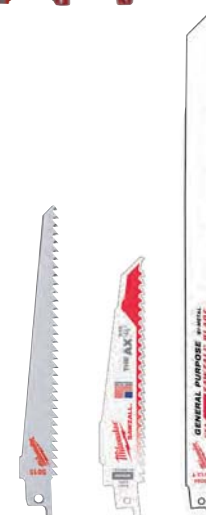

SAWZALL[™] blades for wood/metal demolition/universal - 1 metre row

Pos	Blade length	Teeth per inch	Application	Quantity	Id. No.	EAN Code 45242
1	300	6	Wood	5	48001079	079858
2	150	5	Demolition	5	48005035	082698
3	230	5	Demolition	5	48005036	082704
4	300	5	Demolition	5	48005037	082711
5	200	10/14	Universal	5	48005293	084074
6	200	8/12	Universal	5	48005093	082773
7	300	8/12	Universal	5	48005094	082780
8	150	18	Metal	5	48005184	082858
9	230	18	Metal	5	48005188	082896
10	300	18	Metal	5	48005189	082902
11	150	14	Metal	5	48005182	082834
12	230	14	Metal	5	48005187	082889
13	230	18	Metal – Torch	5	48005788	083091
14	230	14	Metal – Torch	5	48005787	083077
15	230	10	Metal – Torch	5	48005713	083046
16	230		Cast iron – Coarse grit	5	48001430	082001

Pos	Display material	Quantity	Id. No. 4939	EAN Code 4002395
1	1 m Assembled row	1	434656	557967
2	Euro hook (short)	16	434650	557905
3	MILWAUKEE [®] header strip	1	510100	900596
4	Barcode label strip SAWZALL [™] blades top line EU	1	565539	936243
5	Carton	1	4931373861	734399

4932 430516
4002395 381777

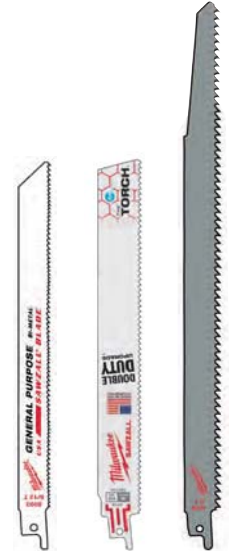

SAWZALL[™] blades for metal - 1 metre row

Pos	Blade length	Teeth per inch	Application	Quantity	Id. No.	EAN Code 45242
1	150	25	Metal	5	48005186	082872
2	150	18	Metal	5	48005184	082858
3	230	18	Metal	5	48005188	082896
4	300	18	Metal	5	48005189	082902
5	150	14	Metal	5	48005182	082834
6	230	14	Metal	5	48005187	082889
7	150	18	Metal – Torch	5	48005784	083084
8	230	18	Metal – Torch	5	48005788	083091
9	300	18	Metal – Torch	5	48005789	083107
10	150	14	Metal – Torch	5	48005782	083060
11	230	14	Metal – Torch	5	48005787	083077
12	150	10	Metal – Torch	5	48005712	083039
13	230	10	Metal – Torch	5	48005713	083046
14	150		Cast iron – Coarse grit	5	48001420	081950
15	230		Cast iron – Coarse grit	5	48001430	082001

Pos	Display material	Quantity	Id. No. 4939	EAN Code 4002395
1	1 m Assembled row	1	434656	557967
2	Euro hook (short)	15	434650	557905
3	MILWAUKEE [®] header strip	1	510100	900596
4	Barcode label strip SAWZALL [™] blades for metal	1	565540	936250
5	Carton	1	4931373861	734399

4932 430517
4002395 381784



SAWZALL™ blades for metal - top line - 1 metre row

Pos	Blade length	Teeth per inch	Application	Quantity	Id. No.	EAN Code 45242
1	150	18	Metal – Ice Hardened	5	48004184	081042
2	230	18	Metal – Ice Hardened	5	48004188	081066
3	150	14	Metal – Ice Hardened	5	48004182	081035
4	230	14	Metal – Ice Hardened	5	48004187	080991
5	150	18	Metal – Torch Ice Hardened	5	48004784	081110
6	230	18	Metal – Torch Ice Hardened	5	48004788	081134
7	150	14	Metal – Torch Ice Hardened	5	48004782	081097
8	230	14	Metal – Torch Ice Hardened	5	48004787	081127
9	150	10	Metal – Torch Ice Hardened	5	48004712	081073
10	230	10	Metal – Torch Ice Hardened	5	48004713	081080
11	150	8	Metal – Wrecker	5	48005701	082476
12	230	8	Metal – Wrecker	5	48005706	082483
13	300	8	Metal – Wrecker	5	48005711	082490

4932 430518
4002395 381791



Pos	Display material	Quantity	Id. No. 4939	EAN Code 4002395
1	1 m Assembled row	1	434656	557967
2	Euro hook (short)	13	434650	557905
3	MILWAUKEE® header strip	1	510100	900596
4	Barcode label strip SAWZALL™ blades metal top line	1	565541	936267
5	Carton	1	4931373861	734399

SAWZALL[™] blades Red Rack

Pos	Blade length	Teeth per inch	Application	Quantity	Id. No.	UPC Code 45242
1	230	6	Wood	5	48005016	082636
2	150	5	Demolition AX	5	48005021	082988
3	230	5	Demolition AX	5	48005026	082995
4	300	5	Demolition AX	5	48005027	083022
5	230	5	Demolition AX	5	48005036	082704
6	200	10/14	Universal	5	48005293	084074
7	150	8/12	Universal	5	48005091	082759
8	200	8/12	Universal	5	48005093	082773
9	230		Cast iron – Diamond grit	3	48001450	187416
10	450	1.5	Brick	3	48001460	235353
11	150	18	Metal	5	48005184	082858
12	230	18	Metal	5	48005188	082896
13	230	14	Metal	5	48005187	082889
14	150	14	Metal	5	48005182	082834
15	230	14	Metal – Torch	5	48005787	083077
16	150	14	Metal – Torch	5	48005782	083060
17	300	18	Metal	5	48005189	082902

Pos	Display material	Quantity	Id. No. 4939	EAN Code 4002395
1	Red Rack / Header Card	1	434075	930852
2	Euro hook (short)	17	434076	920655
3	Euro hook (long)	2	434080	920648
4	Barcode label set SAWZALL [™] blades	1	434087	920617
5	Planogram SAWZALL [™] blades	1	434179	923991

4932 352647
4002395 373055



Jigsaw blades Red Rack

Pos	Blade length (toothed) mm	Tooth pitch mm	Ref. No.	Quantity	Id. No. 4932	EAN Code 4002395
1	75	4.0	T 144 D	5	213116	301492
2	55	2.0	T 118 B	5	254064	301591
3	75	2.5	T 101 B	5	254061	301522
4	75	4.0	T 101 D	5	274351	301515
5	75	3.0	T 111 C	5	254071	301539
6	91	2.5	T 234 X	5	430141	378029
7	75	4.0	Special	5	265312	301478
8	75	2.5	T 101 BR	5	346079	312382
9	105	4.0	T 344 D	5	311633	301508
10	105	4.0	T 301 DL	5	346071	312399
11	5pc jigsaw blade set with 213116, 254061, 254063, 254064, 254071			5	345825	314850
12	55	0.7	T 118 G	5	274652	301621
13	55	1.2	T 118 A	5	254063	301614
14	66	1.2	T 118 A	5	345826	313464
15	91	2.5/1.8	T 123 XF	5	430142	378036
16	55	1.2	T 118 AF	5	340011	304684
17	55	2.0	T 118 BF	5	340012	304691
18	105	2.0	T 318 BF	5	274653	301584

Pos	Display material	Quantity	Id. No. 4939	EAN Code 4002395
1	Red Rack / Header Card	1	434075	930852
2	Euro hook (short)	18	434076	920655
3	Euro hook (long)	2	434080	920648
4	Barcode label set jigsaw blades	1	434089	920631
5	Planogram jigsaw blades	1	434180	924004

4932 352648
4002395 373062



Holesaws Red Rack

Pos	Application	Quantity	Id. No.	UPC Code 45242
1	Holesaw 19 mm	2	49560023	192632
2	Holesaw 20 mm	2	49560024	271016
3	Holesaw 22 mm	2	49560032	192878
4	Holesaw 25 mm	2	49560043	192526
5	Holesaw 32 mm	2	49560062	192977
6	Holesaw 35 mm	2	49560072	192991
7	Holesaw 40 mm	2	49560087	193042
8	Holesaw 44 mm	2	49560102	193097
9	Holesaw 52 mm	2	49560122	193172
10	Holesaw 54 mm	2	49560127	193189
11	Holesaw 60 mm	2	49560142	193233
12	Holesaw 65 mm	2	49560153	193271
13	Holesaw 67 mm	2	49560158	193288
14	Holesaw 76 mm	1	49560173	193332
15	Holesaw 86 mm	1	49560187	193387
16	Holesaw 102 mm	1	49560213	193486
17	Holesaw 111 mm	1	49560227	193530
18	Arbor 9.5 mm / 14-30 mm	2	49567010	200177
19	Arbor 9,5 mm / 32-210 mm	2	49567250	225798
20	Arbor 11 mm / 32-210 mm	2	49569100	200832
21	Pilot drill 6x89	5	49568010	200450
22	Holesaw 4/6 Set-17pcs	1	49224102	271054

Pos	Display material	Quantity	Id. No. 4939	EAN Code 4002395
1	Red Rack / Header Card	1	434075	930852
2	Euro hook (short)	6	434076	920655
3	Euro hook (long)	15	434077	920662
4	Re Order Tag (10pcs)	3	434080	920648
5	EAN LB	1	434409	551521

4932 430177
4002395 378388



Holesaws Red Rack #2

NEW

4932 471401
4058546 290290



Pos	Item	Quantity	Id. No.	EAN Code 45242
1	Holedozer – 19 mm	3	49560023	192632
2	Holedozer – 20 mm	3	49560024	271016
3	Holedozer – 22 mm	3	49560032	192878
4	Holedozer – 25 mm	3	49560043	192526
5	Holedozer – 27 mm	3	49560047	192892
6	Holedozer – 29 mm	3	49560052	192939
7	Holedozer – 30 mm	3	49560057	192946
8	Holedozer – 32 mm	3	49560062	192977
9	Holedozer – 35 mm	3	49560072	192991
10	Holedozer – 40 mm	3	49560087	193042
11	Holedozer – 44 mm	3	49560102	193097
12	Holedozer – 51 mm	3	49560117	193141
13	Holedozer – 60 mm	3	49560142	193233
14	Holedozer – 76 mm	3	49560173	193332
15	Holedozer – 79 mm	3	49560177	193349
16	Holedozer – 83 mm	3	49560183	193370
17	Holedozer – 102 mm	3	49560213	193486
18	Holesaw arbor 14–30 mm	3	49567010	200177
19	Holesaw arbor 32–150 mm	3	49567250	225798
20	Holesaw arbor 32–210 mm	2	49569100	200832
21	H/S PDrill 6x89	5	49568010	200450

Pos	Display material	Quantity	Id. No. 4939	EAN Code 4002395
1	Red Rack / Header+cards	1	434075	30852
2	Short Euro Hooks (1pc)	6	434076	20655
3	Long Euro Hooks (Singles)	15	434077	20662
4	Re Order Tag (10pcs)	3	434080	20648
5	EAN LB	1	434409	51521

SHOCKWAVE™ IMPACT DUTY Drilling & Driving - Red Rack

4932 451317
4002395 151998



Pos	Size Ø mm	A mm	Quantity	Id. No. 4932	EAN Code 4002395
① Screwdriving bits					
1	PH 1	25	5	430850	385126
2	PH 2	25	5	430852	385140
3	PZ1	25	5	430860	385225
4	PZ 2	25	5	430863	385256
5	PZ 3	25	5	430868	385300
6	TX 10	25	5	430871	385331
7	TX 15	25	5	430872	385348
8	TX 20	25	5	430874	385362
9	TX 25	25	5	430879	385416
10	TX 30	25	5	430885	385478
11	Hex 4 mm	25	5	430895	385577
12	Hex 5 mm	25	5	430896	385584
13	PH 2	50	5	430854	385164
14	PZ 2	50	5	430865	385270
15	TX 20	50	5	430876	385386
16	TX 25	50	5	430881	385430
②	Magnetic bit holder	65	8	352406	370658
	Magnetic bit holder	152	5	471822	45242301980
③	PH 2 (25pc box)	25	3	430853	385157
	PZ 2 (25pc box)	25	3	430864	385263
	TX 20 (25pc box)	25	3	430875	385379
	TX 25 (25pc box)	25	3	430880	385423
④ RED HEX - Shockwave HSS-Ground Titanium Metal drill bits					
23	3.0	70	5	48894763	045242506866
24	4.0	80	5	48894708	045242501595
25	5.0	90	5	48894712	045242501632
26	6.0	93	5	48894714	045242501649
27	7.0	109	5	48894717	045242501670
28	8.0	111	5	48894719	045242501694
⑤ Magnetic nut drivers					
29	7.0	65	5	352539	371976
30	8.0	65	5	352541	371990
31	10.0	65	4	352543	372010
32	13.0	65	4	352545	372034
⑥	48pc SHOCKWAVE™ IMPACT DUTY drill & drive set		3	430906	385683

Pos	Display material	Quantity	Id. No. 4939	EAN Code 4002395
1	Red Rack / Header Card	1	434075	930852
2	Euro hook (short)	26	434076	920655
3	Euro hook (long)	7	434077	920662
4	Re Order Tag Set (10pcs)	4	434080	920648
5	Barcode label set SHOCKWAVE™ IMPACT DUTY Accessories	1	434088	920624
6	Planogram SHOCKWAVE™ IMPACT DUTY Accessories	1	434178	923984



Nothing but **HEAVY DUTY.**[™]

Notes



Nothing but **HEAVY DUTY.**TM

TiD-extra
Industrial Technologies d.o.o.

Ekskluzivni distributer i ovlašteni servis u Hrvatskoj:

TiD-extra d.o.o.

Slatine 6

HR- 40315 Mursko Središće

Tel: 040544541

Fax: 040544542

Email: milwaukeeinfo@tid-extra.hr

www.tid-extra.hr

Techtronic Industries GmbH

Max-Eyth-Str. 10

D-71364 Winnenden

Germany

Tel. +49 7195 120

Fax +49 7195 666

Distributed by: